

Bioinorganic Chemistry

Content

1. What is bioinorganic chemistry?
2. Evolution of elements
3. Elements and molecules of life
4. Phylogeny
5. Metals in biochemistry
6. Ligands in biochemistry
7. Principals of coordination chemistry
8. Properties of bio molecules
9. Biochemistry of main group elements
10. Biochemistry of transition metals
11. Biochemistry of lanthanides and actinides
12. Modell complexes
13. Analytical methods in bioinorganic
14. Applications areas of bioinorganic chemistry

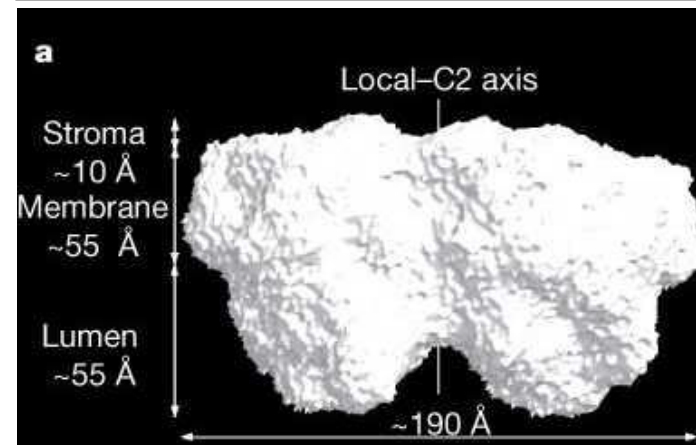
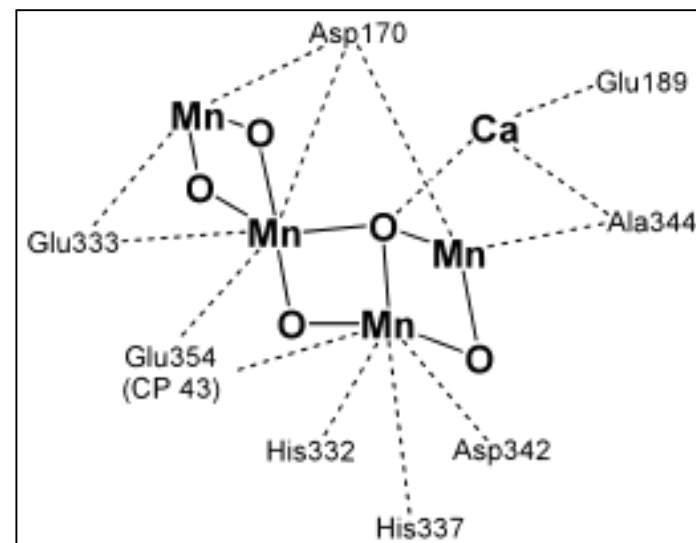

"Simplicity is the ultimate sophistication" Leonardo Da Vinci

Literature

- C. Elschenbroich, A. Salzer, Organometallchemie, 2. Auflage, Teubner, 1988
- S.J. Lippard, J.N. Berg, Bioinorganic Chemistry, Spektrum Akademischer Verlag, 1995
- J.E. Huheey, E. Keiter, R. Keiter, Anorganische Chemie – Prinzipien von Struktur und Reaktivität, 3. Auflage, Walter de Gruyter, 2003
- W. Kaim, B. Schwederski: Bioinorganic Chemistry, 4. Auflage, Vieweg-Teubner, 2005
- H. Rauchfuß, Chemische Evolution und der Ursprung des Lebens, Springer, 2005
- A.F. Hollemann, N. Wiberg, Lehrbuch der Anorganischen Chemie, 102. Auflage, de Gruyter, 2007
- I. Bertini, H.B. Gray, E.I. Stiefel, J.S. Valentine, Biological Chemistry, University Science Books, 2007
- N. Metzler-Nolte, U. Schatzschneider, Bioinorganic Chemistry: A Practical Course, Walter de Gruyter, 2009
- W. Ternes, Biochemie der Elemente, Springer, 2013
- D. Rabinovich, Bioinorganic Chemistry, Walter de Gruyter, 2020
- F. Williams, Principles of Bioinorganic Chemistry, Murphy & Moore Publ., 2022

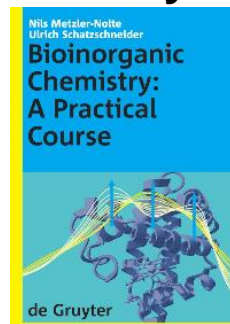

1. What is Bioinorganic Chemistry?

A Highly Interdisciplinary Science at the Verge of Biology, Chemistry, Physics, and Medicine

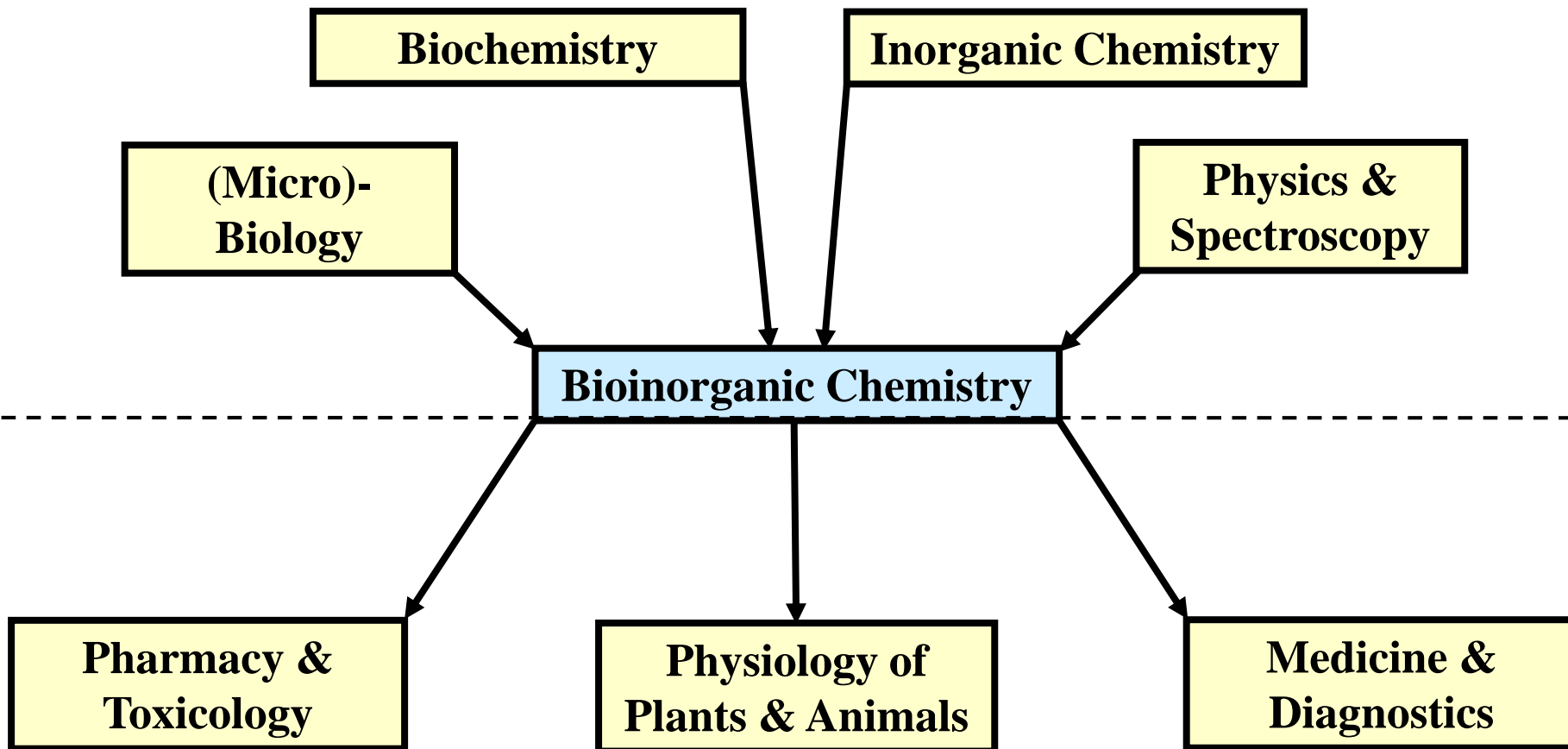

2. Evolution of the Elements

Most Abundant Elements in the Universe according to Atom Number Fractions are

1.	Hydrogen	88.6%	Reactive: H_2 , H_2O , CH_4 → biology
2.	Helium	11.3%	Noble gas → atmospheres
3.	Oxygen	0.063%	Reactive: O_2 , H_2O → biology
4.	Carbon	0.035%	Reactive: CO_2 , CH_4 → biology
5.	Nitrogen	0.011%	Reactive: N_2 , NH_3 → biology
6.	Neon	0.010%	Noble gas → atmospheres
7.	Magnesium	0.0032 %	Oxides → planetary crusts
8.	Silicon	0.0029 %	Silicates → planetary crusts

Elements from Lithium onwards, which are regarded as metals by astronomers, contribute to only about 0.1%

Whilst hydrogen, helium, and traces of lithium have been formed during the big bang, all other heavier elements up to iron had to be generated by fission within the stars. Even heavier elements were formed only in supernovae (SN) events or in super giants.



4He production in stars and during the big bang

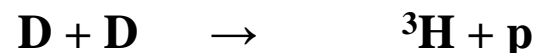
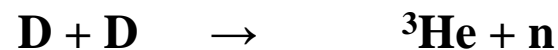

2. Evolution of Elements

Table of Isotopes of the Light Elements (Stable Isotopes are Drawn in Blue)

10								^{17}Ne	^{18}Ne
9								^{16}F	^{17}F
8						^{13}O	^{14}O	^{15}O	^{16}O
7						^{12}N	^{13}N	^{14}N	^{15}N
6				^9C	^{10}C	^{11}C	^{12}C	^{13}C	^{14}C
5				^8B	^9B	^{10}B	^{11}B	^{12}B	^{13}B
4			^6Be	^7Be	^8Be	^9Be	^{10}Be	^{11}Be	^{12}Be
3			^5Li	^6Li	^7Li	^8Li	^9Li		
2		^3He	^4He	^5He	^6He		^8He		
1	^1H	^2H	^3H						
	0	1	2	3	4	5	6	7	8

Beryllium ^9Be is the first element with solely one stable isotope (pure element): Very toxic...

Fluorine ^{19}F is the first biochemical relevant element with solely one stable isotope...

Phosphorus ^{31}P is the only stable isotope and the most critical element for biology...

2. Evolution of Elements

Formation of Moderately Heavy Elements (Stellar Synthesis)

Several fusion processes lead to a number of products:



Formation of phosphorus (rare)

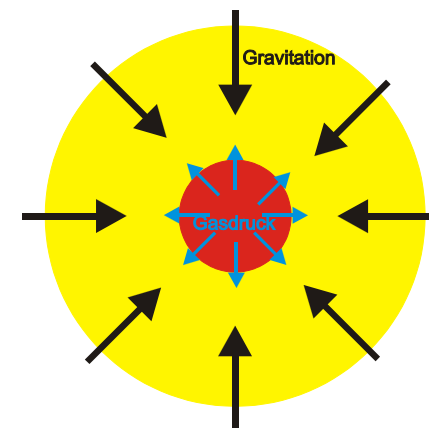
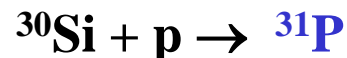
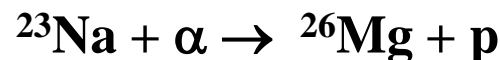
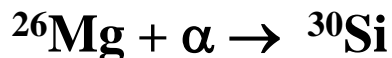

Pre-supernova burning stages of a star with 25 times the solar mass

Burn process	T [10^9 K]	Main products	Duration of burning stage
H	0.02	${}^4\text{He}, {}^{14}\text{N}$	$7 \cdot 10^6$ a
He	0.2	${}^{12}\text{C}, {}^{16}\text{O}, {}^{20}\text{Ne}$	$5 \cdot 10^5$ a
C	0.8	${}^{20}\text{Ne}, {}^{23}\text{Na}, {}^{24}\text{Mg}$	$6 \cdot 10^2$ a
Ne	1.5	${}^{20}\text{Ne}, {}^{23}\text{Na}, {}^{24}\text{Mg}$	1 a
O	2.0	${}^{28}\text{Si}, {}^{32}\text{S}, {}^{40}\text{Ca}$	180 days
Si	3.5	${}^{54}\text{Fe}, {}^{56}\text{Ni}, {}^{52}\text{Cr}$	1 day!

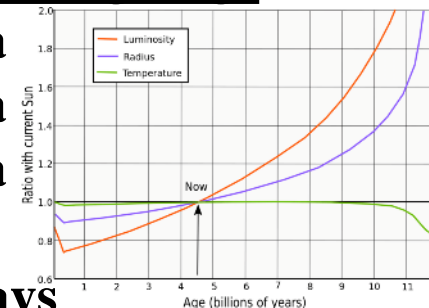

2. Evolution of Elements

Formation of the Heavy Elements

S(slow)-process (in red supergiants):

- **Kinetics:** Time of β -decay must be orders of magnitude higher than the period till the next capture of a neutron
- Starting points are seed cores such as ^{56}Fe
- They capture neutrons \rightarrow ^{59}Fe and decompose via a β -decay to ^{59}Co
- This process is repeating itself \rightarrow the process moves along the stability valley of the table of isotopes



Bild 9.7. Verzweigung der s- und r-Prozesse zur Elementbildung oberhalb Eisen

2. Evolution of Elements

Formation of the Heavy Elements

R(rapid)-process (in supernovae, SN):

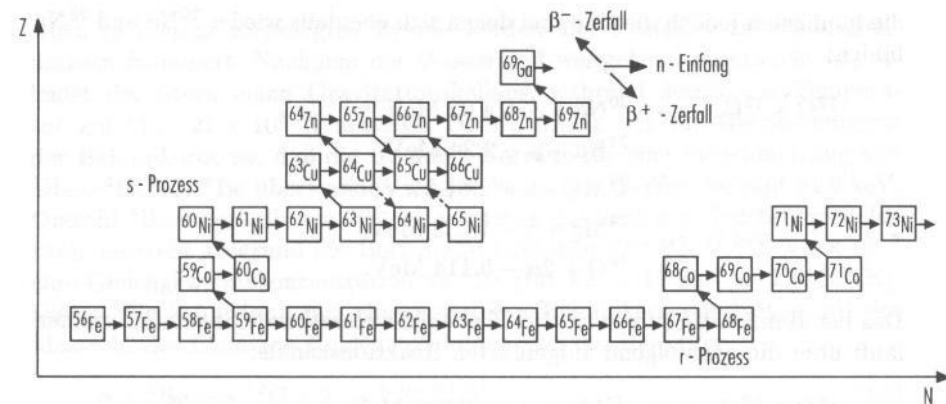
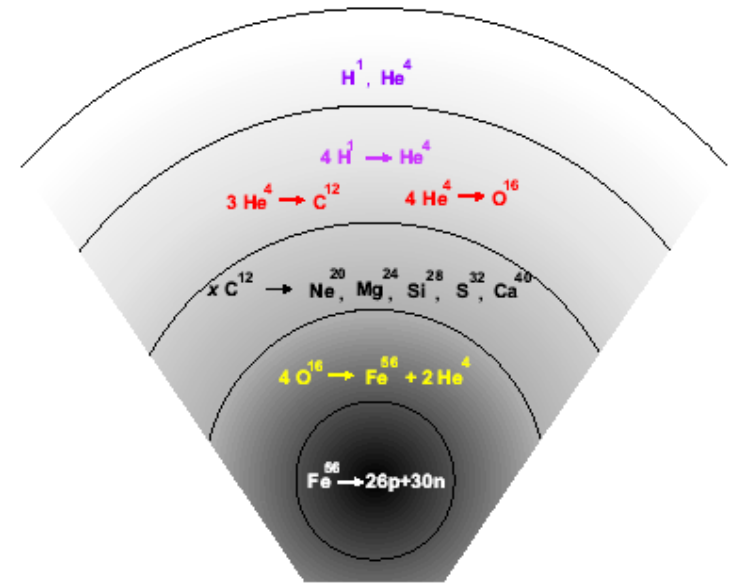
- Requires extremely high flux of neutrons to compensate for the β -decay
- The core is enriched with neutrons (20 - 30 neutrons) until it reaches the “neutron drip line“. By spontaneous emission of neutrons the core remains in that waiting state until it decomposes via the β -decay
- Such neutron density (10^{24} cm^{-3}) is reached by photo disintegration within the core of SN

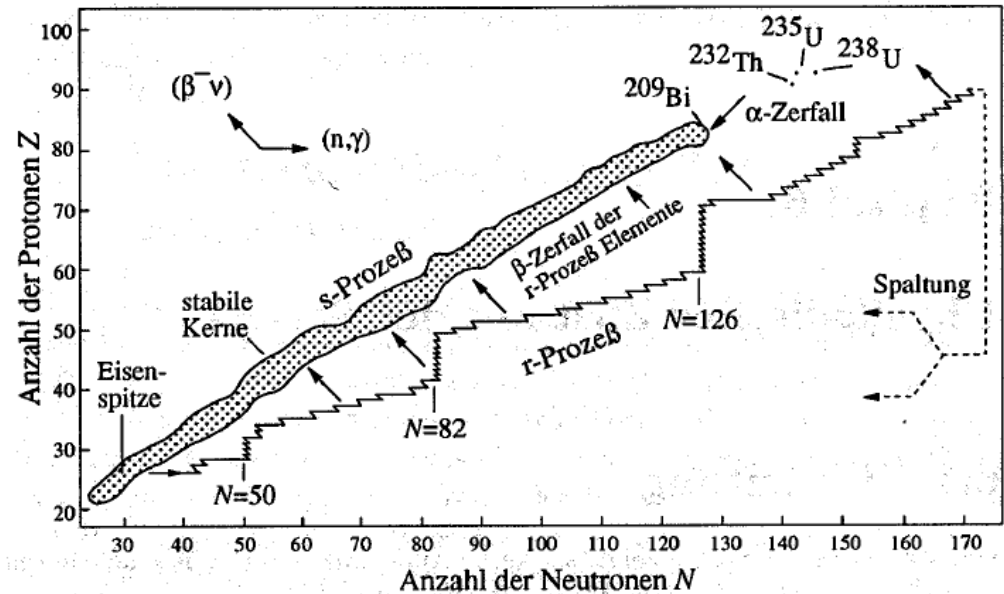

2. Evolution of Elements

Groups																		18						
1																	2							
1 H																	13	14	15	16	17	18 He	1	
3 Li	4 Be																	5 B	6 C	7 N	8 O	9 F	10 Ne	2
11 Na	12 Mg	3	4	5	6	7	8	9	10	11	12	13 Al	14 Si	15 P	16 S	17 Cl	18 Ar	3						
19 K	20 Ca	21 Sc	22 Ti	23 V	24 Cr	25 Mn	26 Fe	27 Co	28 Ni	29 Cu	30 Zn	31 Ga	32 Ge	33 As	34 Se	35 Br	36 Kr	4						
37 Rb	38 Sr	39 Y	40 Zr	41 Nb	42 Mo	43 Tc	44 Ru	45 Rh	46 Pd	47 Ag	48 Cd	49 In	50 Sn	51 Sb	52 Te	53 I	54 Xe	5						
55 Cs	56 B	57 La	72 Hf	73 Ta	74 W	75 Re	76 Os	77 Ir	78 Pt	79 Au	80 Hg	81 Tl	82 Pb	83 Bi	84 Po	85 At	86 Rn	6						
87 Fr	88 Ra	89 Ac	104 Rf	105 Db	106 Sg	107 Bh	108 Hs	109 Mt	110 Ds	111 Rg	112 Cn							7						

58 Ce	59 Pr	60 Nd	61 Pm	62 Sm	63 Eu	64 Gd	65 Tb	66 Dy	67 Ho	68 Er	69 Tm	70 Yb	71 Lu	6
90 Th	91 Pa	92 U	93 Np	94 Pu	95 Am	96 Cm	97 Bk	98 Cf	99 Es	100 Fm	101 Md	102 No	103 Lr	7

Synthesis within 15 min after the big bang

stellar synthesis

Stellar formation via the s(slow)-process (neutron capture and β -decay)

Formation via the (rapid)-process during supernovae explosions of the type II

2. Evolution of Elements

Distribution within the Interstellar Medium

1. Supernovae explosions, e.g. in Supernova Type Ia of white dwarfs (SN1572, observed by Danish astronomer Tycho Brahe)
2. T-Tauri stars → strong stellar winds, e.g. in the columns of creation (JWST)

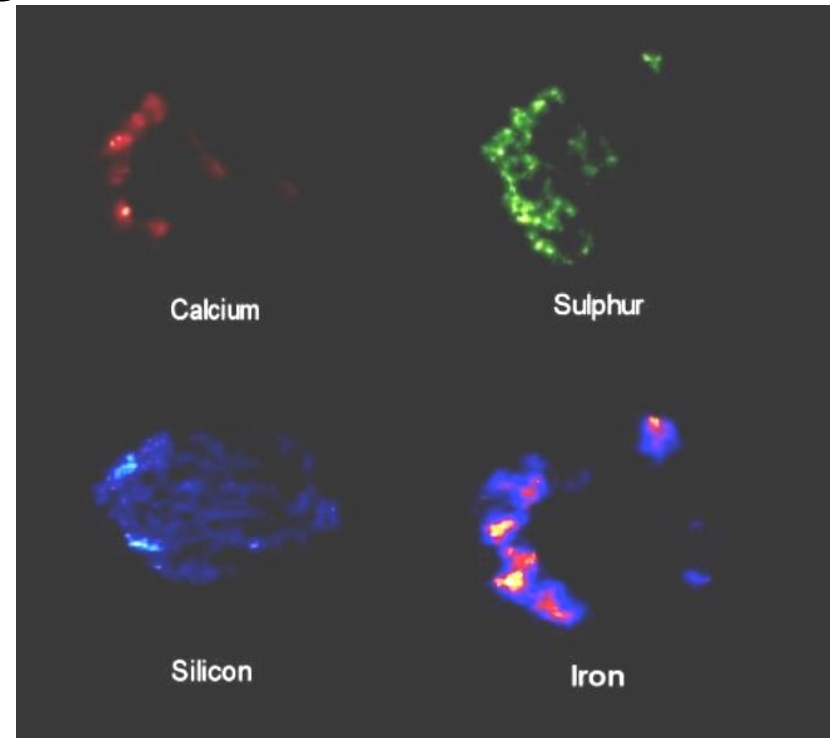
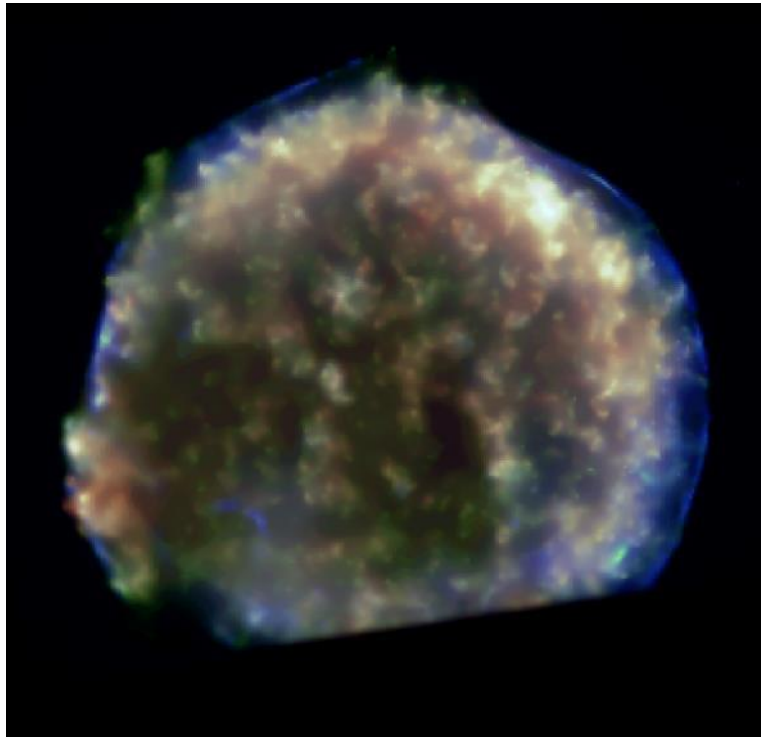

X-ray images of SN1572 by space telescope on board of satellite “Chandra”

2. Evolution of Elements

Elemental Composition of the Sun and of Carbonaceous Chondrites (C1) Typical for Stars in the Milky Way

Tabelle 4.9.1. Elementhäufigkeiten $\log N$ im Sonnensystem: Sonne (\odot) nach H. Holweger (1985) und kohlige Chondrite vom Typ C1 nach E. Anders und M. Ebihara (1982). Normierung auf Wasserstoff $\log N(\text{H}) = 12.0$, Anpassung der solaren und meteoritischen Häufigkeitsverteilungen bei Silizium $\log N(\text{Si}) = 7.6$. Bestimmung der Sonnenhäufigkeiten aus der Photosphäre mit Ausnahme von He, Ne, Ar (Korona bzw. Protuberanzen) und Tl (Sonnenflecken). Meteorite: C1-Chondrite bis auf Be, B, Br, Rh, I, für die andere Chondrite herangezogen wurden. Für Kr, Xe, Hg geschätzte Werte aus Interpolationen. Radioaktive Elemente: Th, U Angabe der *heutigen* Häufigkeiten; bei der Entstehung des Sonnensystems vor $4.5 \cdot 10^9$ a (2.8.24) waren die Häufigkeiten um $\delta \log N = 0.2$ (Th) bzw. 0.3 (U) höher

	\odot	C1		\odot	C1		\odot	C1		\odot	C1
1 H	12.0	–	22 Ti	5.1	5.0	44 Ru	1.8	1.9	66 Dy	1.1	1.2
2 He	11.0	–	23 V	4.1	4.1	45 Rh	1.1	1.1	67 Ho	0.3	0.6
3 Li	1.1	3.4	24 Cr	5.8	5.7	46 Pd	1.7	1.7	68 Er	0.9	1.0
4 Be	1.2	1.5	25 Mn	5.4	5.6	47 Ag	0.9	1.3	69 Tm	0.3	0.1
5 B	2.5	3.0	26 Fe	7.6	7.6	48 Cd	1.9	1.8	70 Yb	1.1	1.0
6 C	8.6	–	27 Co	4.9	5.0	49 In	1.7	0.9	71 Lu	0.8	0.2
7 N	8.0	–	28 Ni	6.2	6.3	50 Sn	1.9	2.2	72 Hf	0.9	0.8
8 O	8.9	–	29 Cu	4.2	4.3	51 Sb	1.0	1.1	73 Ta	–	0.0
9 F	4.6	4.5	30 Zn	4.6	4.7	52 Te	–	2.3	74 W	1.1	0.7
10 Ne	7.6	–	31 Ga	2.9	3.2	53 I	–	1.6	75 Re	–	0.3
11 Na	6.3	6.4	32 Ge	3.5	3.7	54 Xe	–	(2.2)	76 Os	1.4	1.5
12 Mg	7.5	7.6	33 As	–	2.4	55 Cs	–	1.2	77 Ir	1.4	1.4
13 Al	6.4	6.5	34 Se	–	3.4	56 Ba	2.1	2.2	78 Pt	1.8	1.7
14 Si	7.6	7.6	35 Br	–	2.7	57 La	1.1	1.3	79 Au	1.1	0.9
15 P	5.4	5.6	36 Kr	–	(3.3)	58 Ce	1.6	1.7	80 Hg	–	(1.3)
16 S	7.2	7.3	37 Rb	2.6	2.5	59 Pr	0.7	0.8	81 Tl	0.9	0.9
17 Cl	–	5.3	38 Sr	3.0	3.0	60 Nd	1.4	1.5	82 Pb	1.9	2.1
18 Ar	6.7	–	39 Y	2.2	2.3	62 Sm	0.8	1.0	83 Bi	–	0.8
19 K	5.1	5.2	40 Zr	2.6	2.6	63 Eu	0.5	0.6	90 Th	0.2	0.1
20 Ca	6.4	6.4	41 Nb	1.4	1.5	64 Gd	1.1	1.1	92 U	–	–0.4
21 Sc	3.1	3.1	42 Mo	1.9	2.0	65 Tb	0.2	0.4			

Normalised by hydrogen by $N(\text{H}) = 12.0$

2. Evolution of Elements

Elemental Composition of the Sun

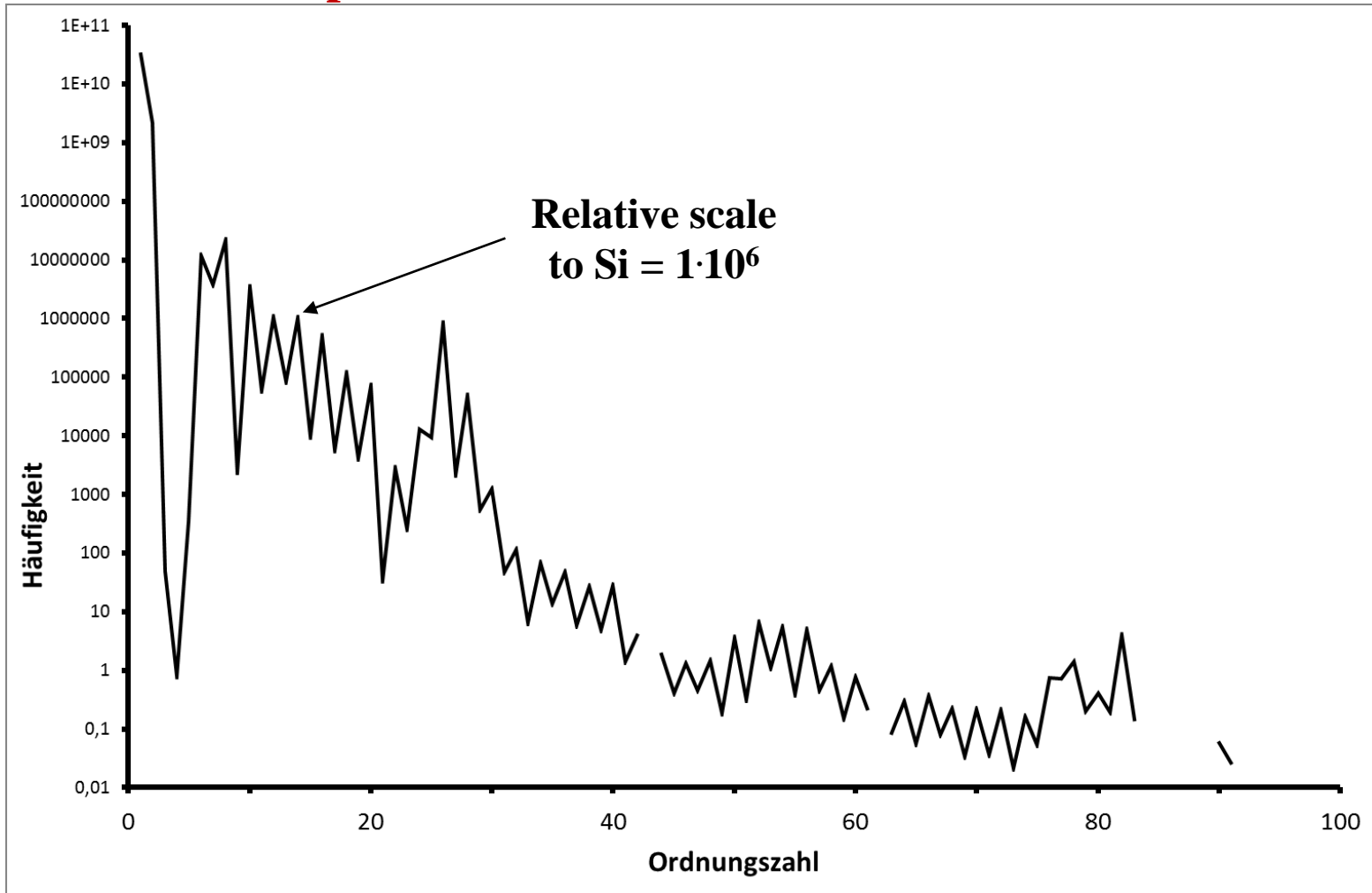

Source:
Wikipedia

The “bio” elements F, P, Cl and K are rather rare!

3. Elements and Molecules of Life

Elemental Composition of the Solar Systems

About 4.7 billion years ago:

81 stable elements existing in the protoplanetary (solar) nebula. That means all elements till Bi, except Tc and Pm, since they only possess short-lived isotopes

About 26 elements in living organisms:

1. Necessary in quantitative amounts: 11 elements

C, H, O, N, S, P, Na, Mg, Cl, K, Ca

2. In smaller amounts needed: 8 elements

Mn, Fe, Co, Ni, Cu, Zn, I, Mo

3. Elements, occurring only in some species: 8 elements

B, F, Si, V, Cr, Se, Sn, W

	C	H	O	N	S	P
Carbohydrates	X	X	X			
Lipides	X	X	X	X		X
Proteins	X	X	X	X	X	
Nucleotides	X	X	X	X		X
Porphyrines	X	X	X	X		

3. Elements and Molecules of Life

Most Abundant Elements of Earth's Crust (Atmo-, Bio-, Hydro-, Cryo- and Lithosphere) According to Weight Fractions:

1. Oxygen	48.9%
2. Silicon	26.3%
3. Aluminium	7.7%
4. Iron	4.7%
5. Calcium	3.4%
6. Sodium	2.6%
7. Potassium	2.4%
8. Magnesium	<u>1.9%</u>
	97.9%



All other elements of the periodic table add up to only 2.1%:

H: 1400 ppm

S 350 ppm

C 200 ppm

Cu 60 ppm

Co 25 ppm

3. Elements and Molecules of Life

Most Abundant Elements in the Human Body According to Weight Fraction

1. Oxygen	65.4%
2. Carbon	18.1%
3. Hydrogen	10.1%
4. Nitrogen	3.0%
5. Calcium	1.5%
6. Phosphorus	1.0%
7. Sulphur	<u>0.25%</u>
	99.35%

All other elements of the periodic table contribute to solely **0.65%** to the mass of humans

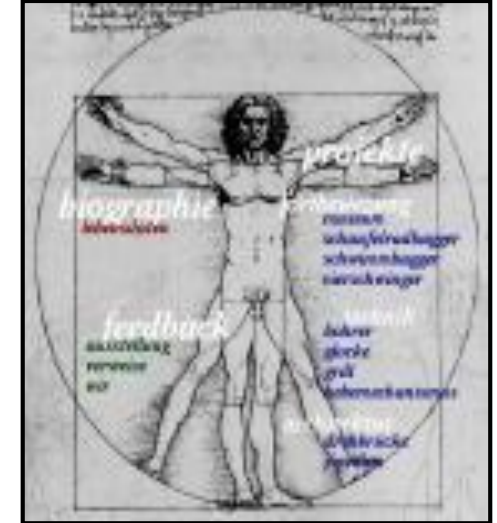

Trace Elements	Daily demand of the human body
Iron	10 - 20 mg
Zinc	7 - 10 mg
Manganese	2 - 5 mg
Copper	1 – 1.5 mg
Molybdenum	0.05 – 0.1 mg
Vanadin	0.01 - 0.03 mg
Cobalt	0.003 mg

3. Elements and Molecules of Life

Composition of the Human Body (70 kg) by the Elemental Weight Fraction

- oxygen 43 kg
- carbon 16 kg
- hydrogen 7 kg
- nitrogen 1.8 kg
- calcium 1.0 kg
- phosphorus 780 g
- potassium 140 g
- sulphur 140 g
- sodium 100 g
- chlorine 95 g
- magnesium 19 g
- iron 4.2 g
- fluorine 2.6 g
- zinc 2.3 g
- silicon 1.0 g
- rubidium 0.68 g
- strontium 0.32 g
- bromine 0.26 g
- lead 0.12 g
- copper 72 mg
- aluminium 60 mg
- cadmium 50 mg
- cerium 40 mg
- barium 22 mg
- iodine 20 mg
- tin 20 mg
- titanium 20 mg
- boron 18 mg
- nickel 15 mg
- selenium 15 mg
- chromium 14 mg
- manganese 12 mg
- arsenic 7 mg
- lithium 7 mg
- caesium 6 mg
- mercury 6 mg
- germanium 5 mg
- molybdenum 5 mg
- cobalt 3 mg
- antimony 2 mg
- silver 2 mg
- niobium 1.5 mg
- zirconium 1 mg
- lanthanum 0.8 mg
- gallium 0.7 mg
- tellurium 0.7 mg
- yttrium 0.6 mg
- bismuth 0.5 mg
- thallium 0.5 mg
- indium 0.4 mg
- gold 0.2 mg
- scandium 0.2 mg
- tantalum 0.2 mg
- vanadium 0.11 mg
- thorium 0.1 mg
- uranium 0.1 mg
- samarium 50 µg
- beryllium 36 µg
- tungsten 20 µg

John Emsley, "The Elements", 3rd ed. Clarendon Press, Oxford, 1998

3. Elements and Molecules of Life

Groups																		
1																	18	
1 H																	2 He	1
3 Li	4 Be											5 B	6 C	7 N	8 O	9 F	10 Ne	2
11 Na	12 Mg	3	4	5	6	7	8	9	10	11	12	13 Al	14 Si	15 P	16 S	17 Cl	18 Ar	3
19 K	20 Ca	21 Sc	22 Ti	23 V	24 Cr	25 Mn	26 Fe	27 Co	28 Ni	29 Cu	30 Zn	31 Ga	32 Ge	33 As	34 Se	35 Br	36 Kr	4
37 Rb	38 Sr	39 Y	40 Zr	41 Nb	42 Mo	43 Tc	44 Ru	45 Rh	46 Pd	47 Ag	48 Cd	49 In	50 Sn	51 Sb	52 Te	53 I	54 Xe	5
55 Cs	56 Ba	57 La	72 Hf	73 Ta	74 W	75 Re	76 Os	77 Ir	78 Pt	79 Au	80 Hg	81 Tl	82 Pb	83 Bi	84 Po	85 At	86 Rn	6
87 Fr	88 Ra	89 Ac	104 Rf	105 Db	106 Sg	107 Bh	108 Hs	109 Mt	110 Ds	111 Rg	112 Cn						7	

58 Ce	59 Pr	60 Nd	61 Pm	62 Sm	63 Eu	64 Gd	65 Tb	66 Dy	67 Ho	68 Er	69 Tm	70 Yb	71 Lu	6
90 Th	91 Pa	92 U	93 Np	94 Pu	95 Am	96 Cm	97 Bk	98 Cf	99 Es	100 Fm	101 Md	102 No	103 Lr	7

Needed in higher quantities
Pharmacological effects

Trace elements
Radioactive elements

Toxic
Diagnostic applications

3. Elements and Molecules of Life

Concentration and Physiological Effect of a Substance



Paracelsus (1493-1541)

„Was ist das nit giftt ist? Alle ding sind giftt/ und nichts ohn giftt/ allein die dosis macht das ein ding kein giftt ist.“

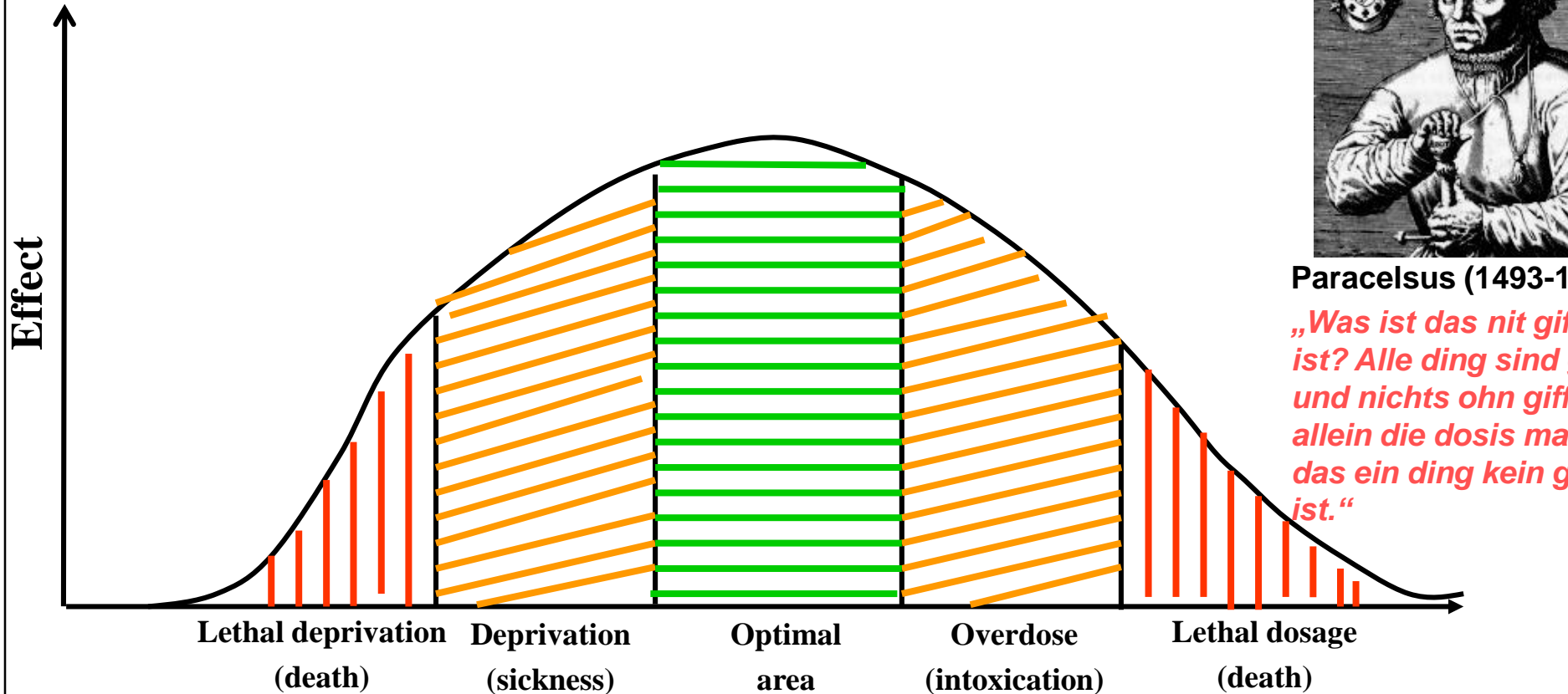

	Lethal deprivation (death)	Deprivation (sickness)	Optimal area	Overdose (intoxication)	Lethal dosage (death)
Fluorine:	0.5 mg		2.0 mg	10 mg	20 mg/day
Selenium:	10 µg		50 µg	200 µg	2 mg/day

3. Elements and Molecules of Life

Formation of Amino acids is crucial to life

Activation by photolysis reactions

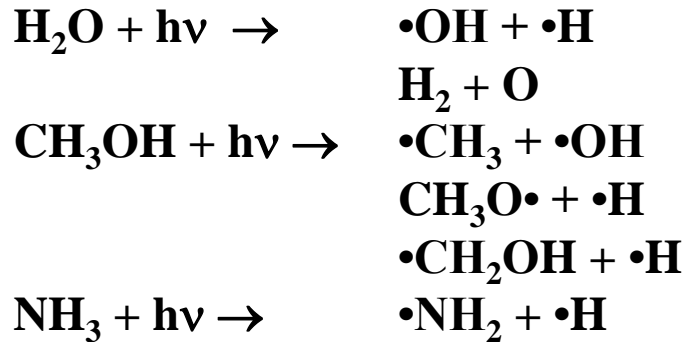

Radical-Radical recombination reactions

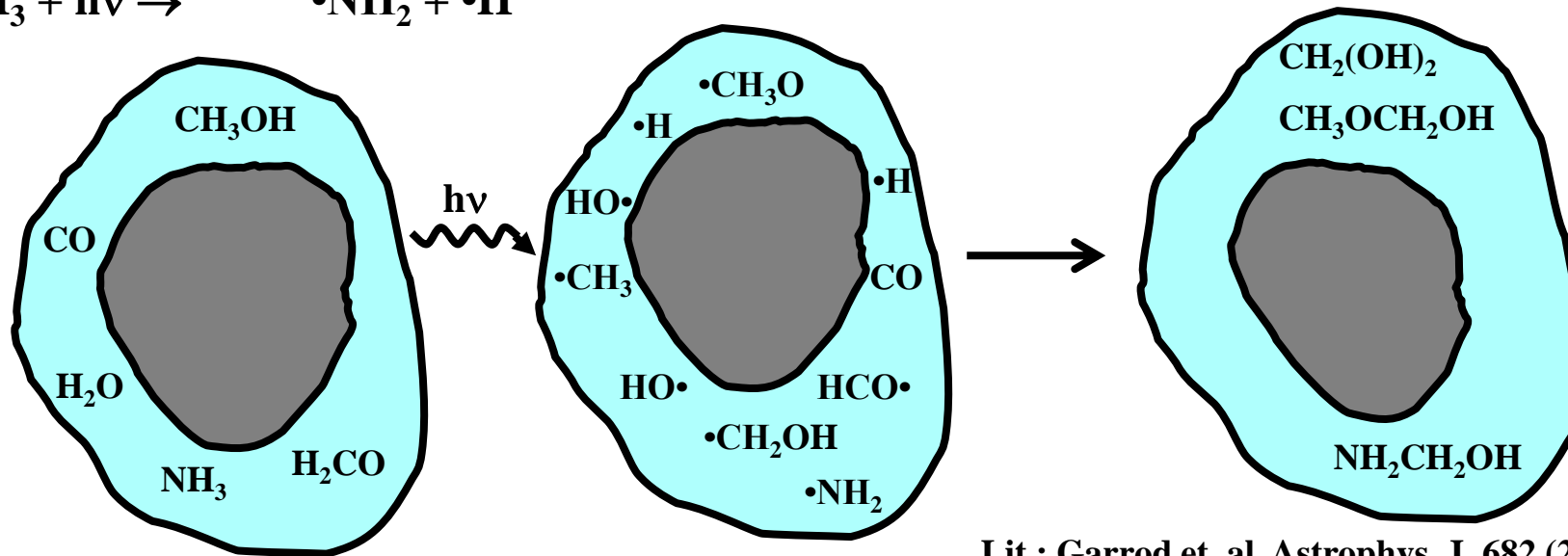
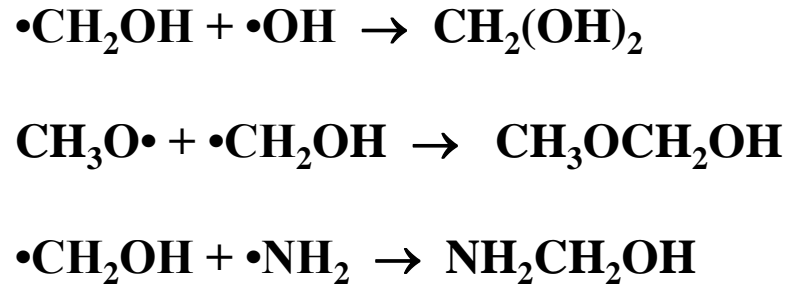

Lit.: Garrod et. al. *Astrophys. J.* 682 (2008) 283-302

3. Elements and Molecules of Life

Probiotic Astrochemistry

Ices evaporate, releasing molecules into the interstellar medium
Molecules can undergo ion-neutral reactions in the gas phase

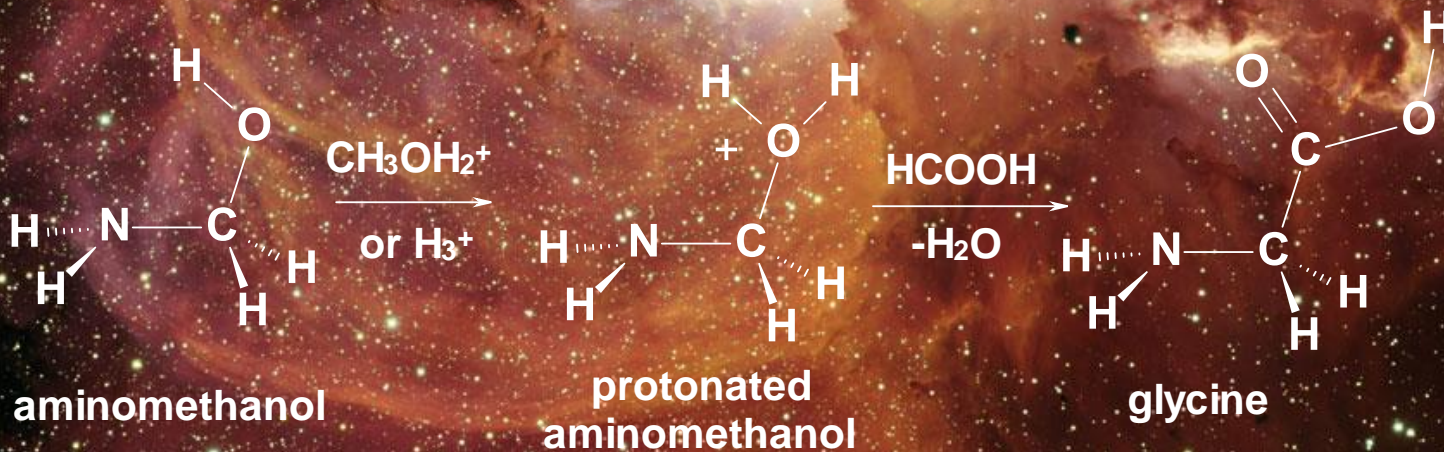
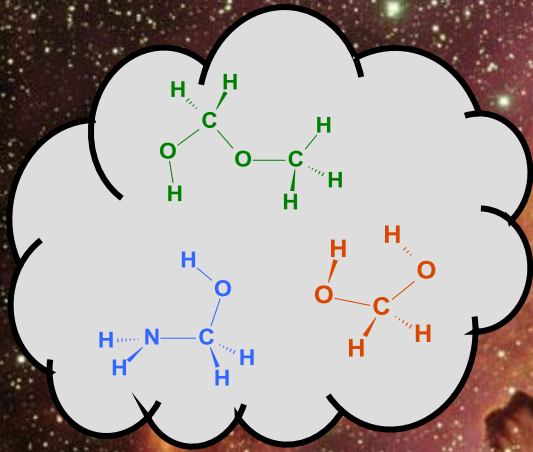

Photograph: T.A. Rector and T. Abbott, U. Alaska and NOAO, AURA, NASA, NGC 3582

3. Elements and Molecules of Life

Probiotic Astrochemistry

Formation of peptides in space without condensation reaction at dust particles of the interstellar medium (ISM), $T \sim 10\text{-}20\text{ K}$:

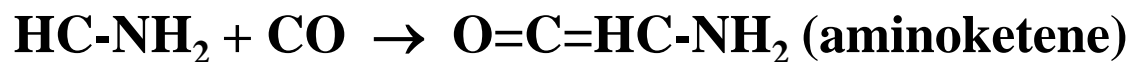
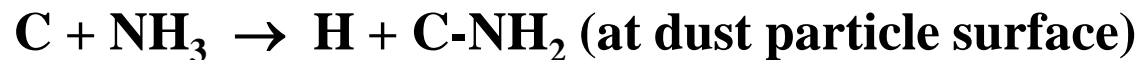

→ polypeptides?

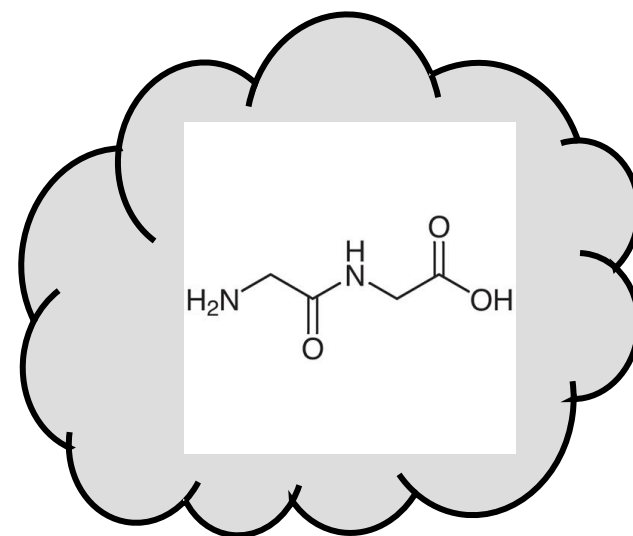

Lit.: Nature Astronomy 6 (2022) 381

3. Elements and Molecules of Life

Probiotic Geochemistry

Primordial atmosphere

$\text{H}_2\uparrow$, $\text{He}\uparrow$, CH_4 , N_2 , NH_3 , H_2O

1st atmosphere (4 bill. years ago)

80% H_2O

10% CO_2

5-7% H_2S

Traces of N_2 , H_2 , CO , He , NH_3

2nd atmosphere (3 bill. years ago)

N_2

Traces of CO_2 , H_2O , and Ar

Present atmosphere

78% N_2 , 21% O_2

0.93% Ar

Traces of CO_2 , H_2O , O_3 , CH_4



Geological Timescale: Concentration of CO_2 and Temperature fluctuations

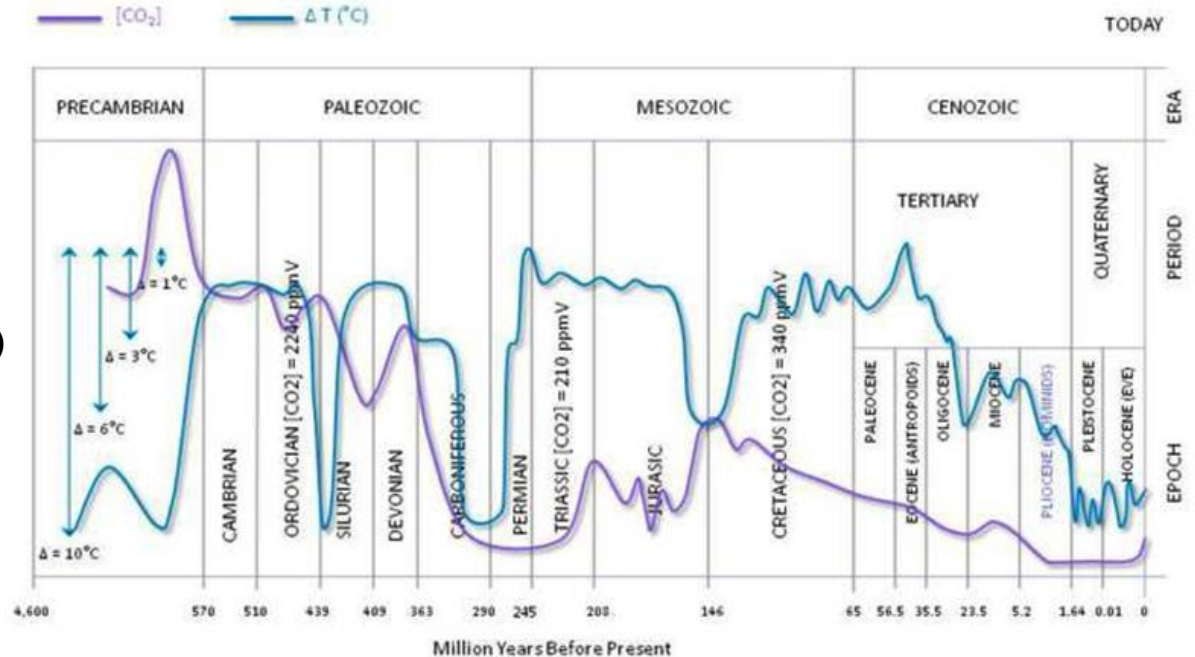

1- Analysis of the Temperature Oscillations in Geological Eras by Dr. C. R. Scotese © 2002. 2- Ruddiman, W. F. 2001. *Earth's Climate: past and future*. W. H. Freeman & Sons. New York, NY. 3- Mark Pagani et al. *Marked Decline in Atmospheric Carbon Dioxide Concentrations During the Paleocene*. *Science*; Vol. 309, No. 5734; pp. 600-603. 22 July 2005. Corrected on 07 July 2008 (CO_2 : Ordovician Period).

4. Phylogeny

The Distribution of Elements in the Terrestrial Atmos-, Bio-, Hydro, Cryo-, and Lithosphere Differs Significantly from the Stellar Distribution of Elements

Earth's core

Heavy elements \Rightarrow Fe, Ni and other metals along with C as carbides

Lithosphere

lighter elements \Rightarrow silicates, aluminosilicate, Mg- and Ca-compounds

Primordial atmosphere

- Rapid emission of H_2 due to too low mass of the earth
- Photolysis of water vapour: $2 H_2O \rightarrow 2 H_2 + O_2$
- Reductive: $CH_4, N_2, NH_3, H_2O, PH_3, H_2S, CO_2$

Present atmo-, hydro-, cryosphere, and lithosphere

- $N_2 \rightarrow NO_x \rightarrow NO_2^-/NO_3^-$ (fertiliser) through lightning
- $CO_2 \rightarrow CO_3^{2-} \rightarrow$ carbonates \downarrow (e.g. dolomite)
- $CO_2 \rightarrow C$ (fossil fuels) + O_2 through biological activity $\rightarrow O_3$ (ozone layer)
- $H_2O(g) \rightarrow H_2O(l)$ "oceans" $\rightarrow H_2O(s)$ "ice caps"

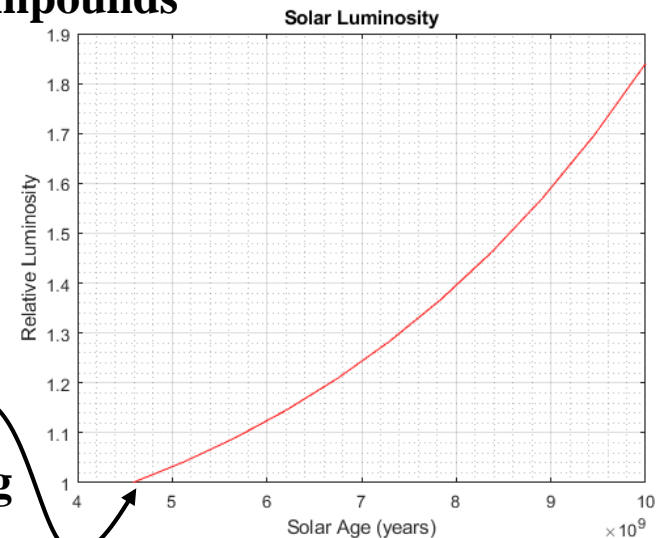

4. Phylogeny

The Biological Phylogenetic Tree

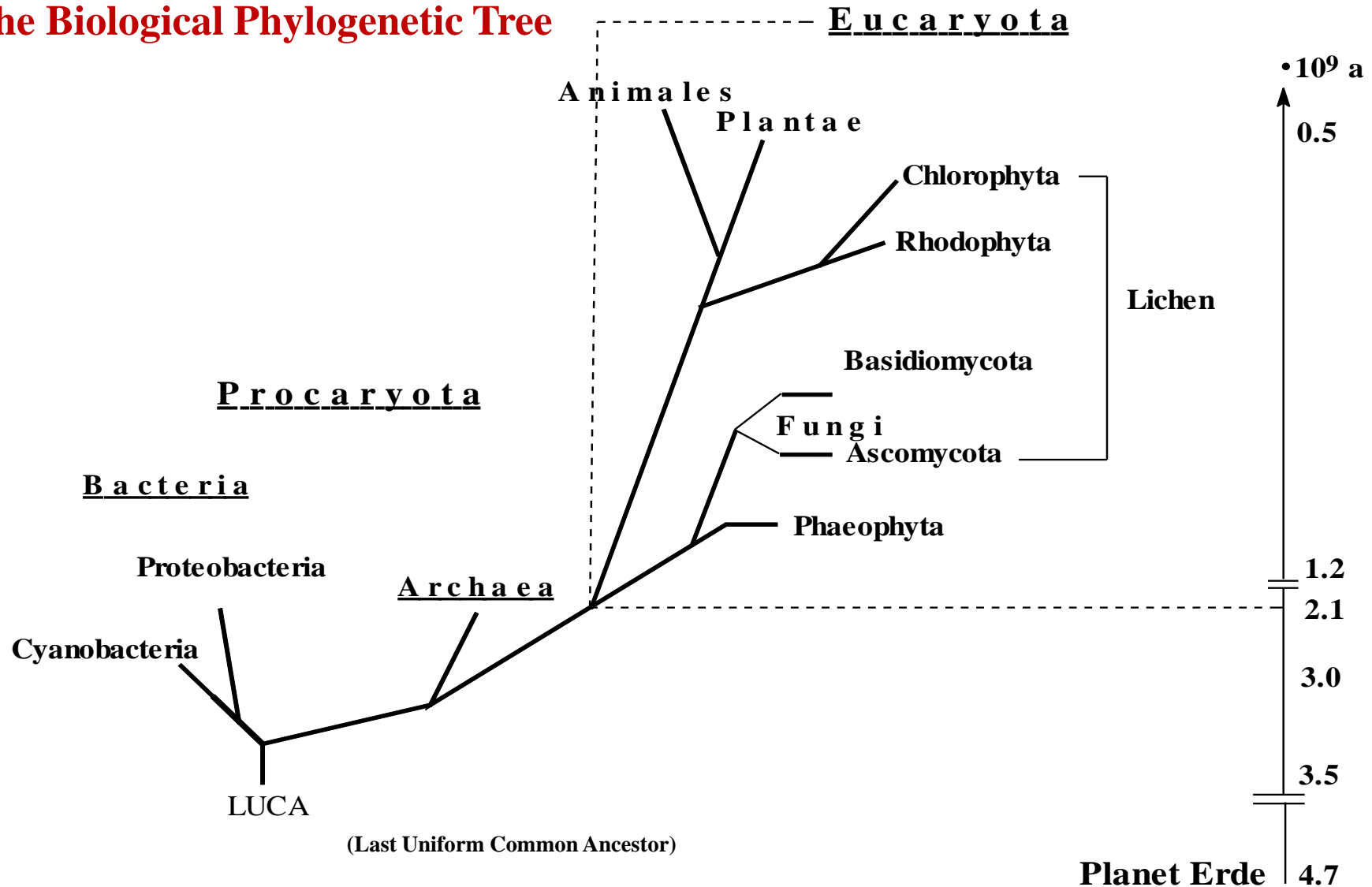

4. Phylogeny

From Prokaryotes to Eukaryotes

Prokaryotes

Bacteria and archaea

→ mostly unicellular but bigger agglomerates possible

Eukaryotes

All higher organisms

Plants

Animals

Fungi

Algae

→ cell core and mitochondria/chloroplasts

→ mostly multicellular

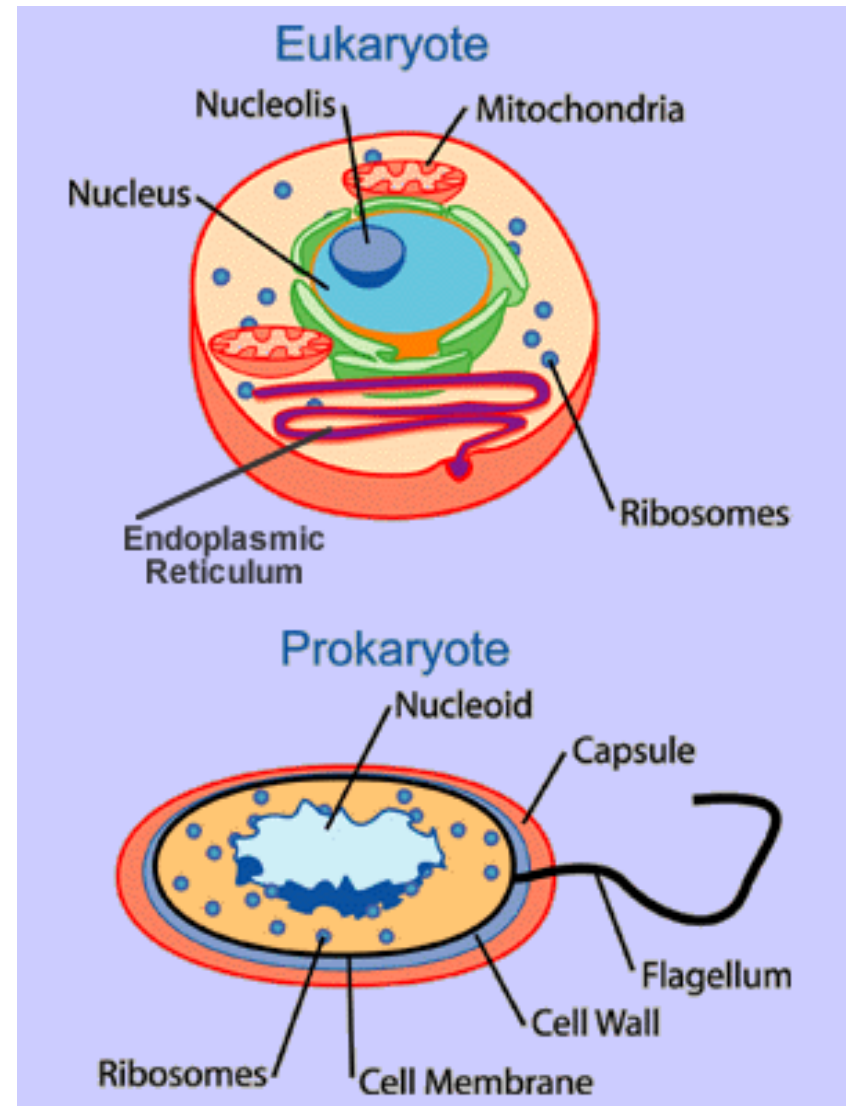

4. Phylogeny

Temporal Variation of Planetary Fe Concentration: Main Driver of Evolution?

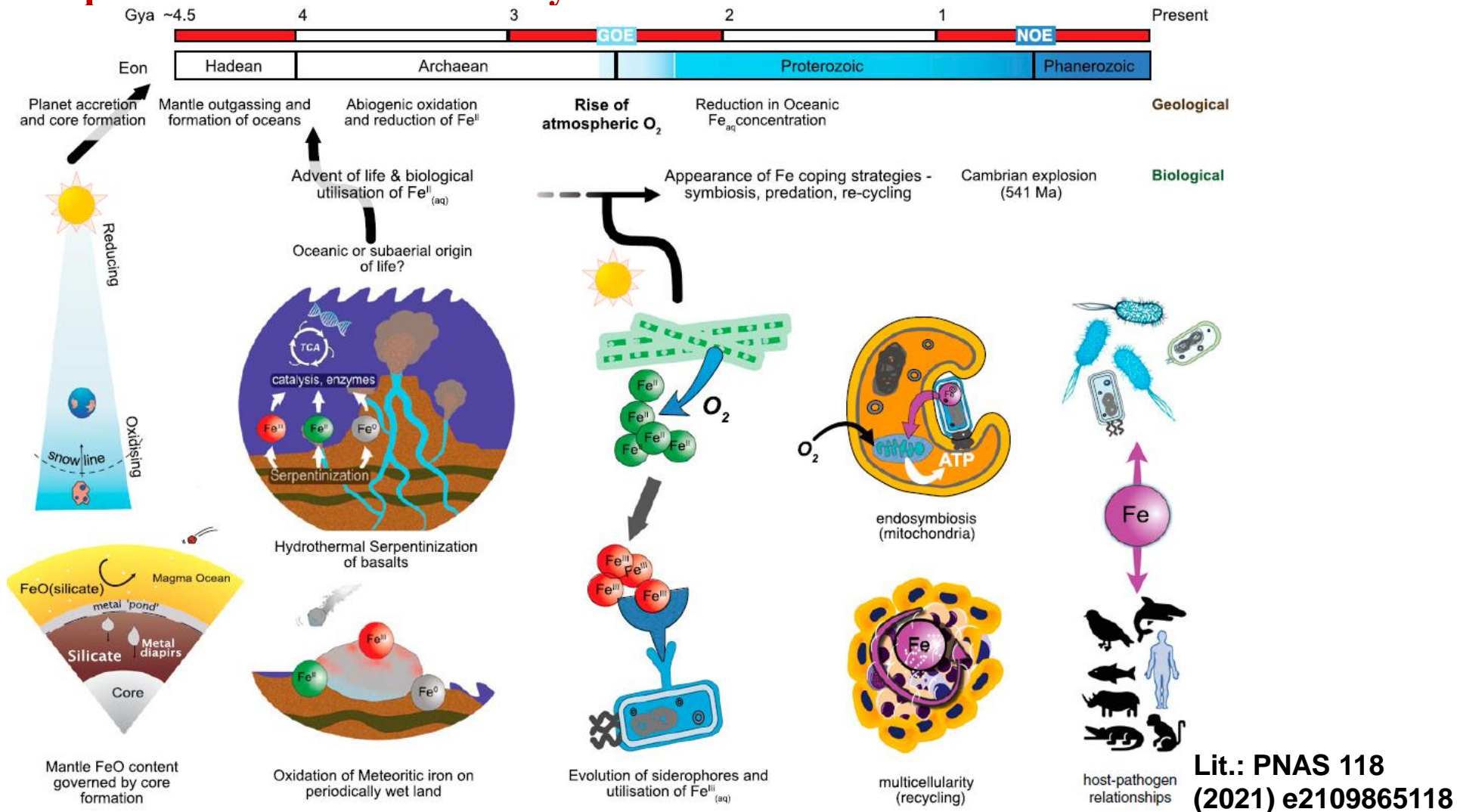

4. Phylogeny

Temporal Variation of Planetary Metal Concentration in Ocean Water

oxic	euxinic	
Fe^{3+}	Fe^{2+}	$\rightarrow \text{FeS}$
VO_4^{3-}	$\text{V}^{2+/3+}$	$\rightarrow \text{VS}_x$
CrO_4^{2-}	$\text{Cr}^{2+/3+}$	$\rightarrow \text{CrS}_x$
MoO_4^{2-}	$\text{Mo}^{2+/3+}$	$\rightarrow \text{MoS}_x$

Euxenic conditions causes severe depletion of transition metals in ocean water

e.g. at P/T mass extinction about 252 mill. years ago

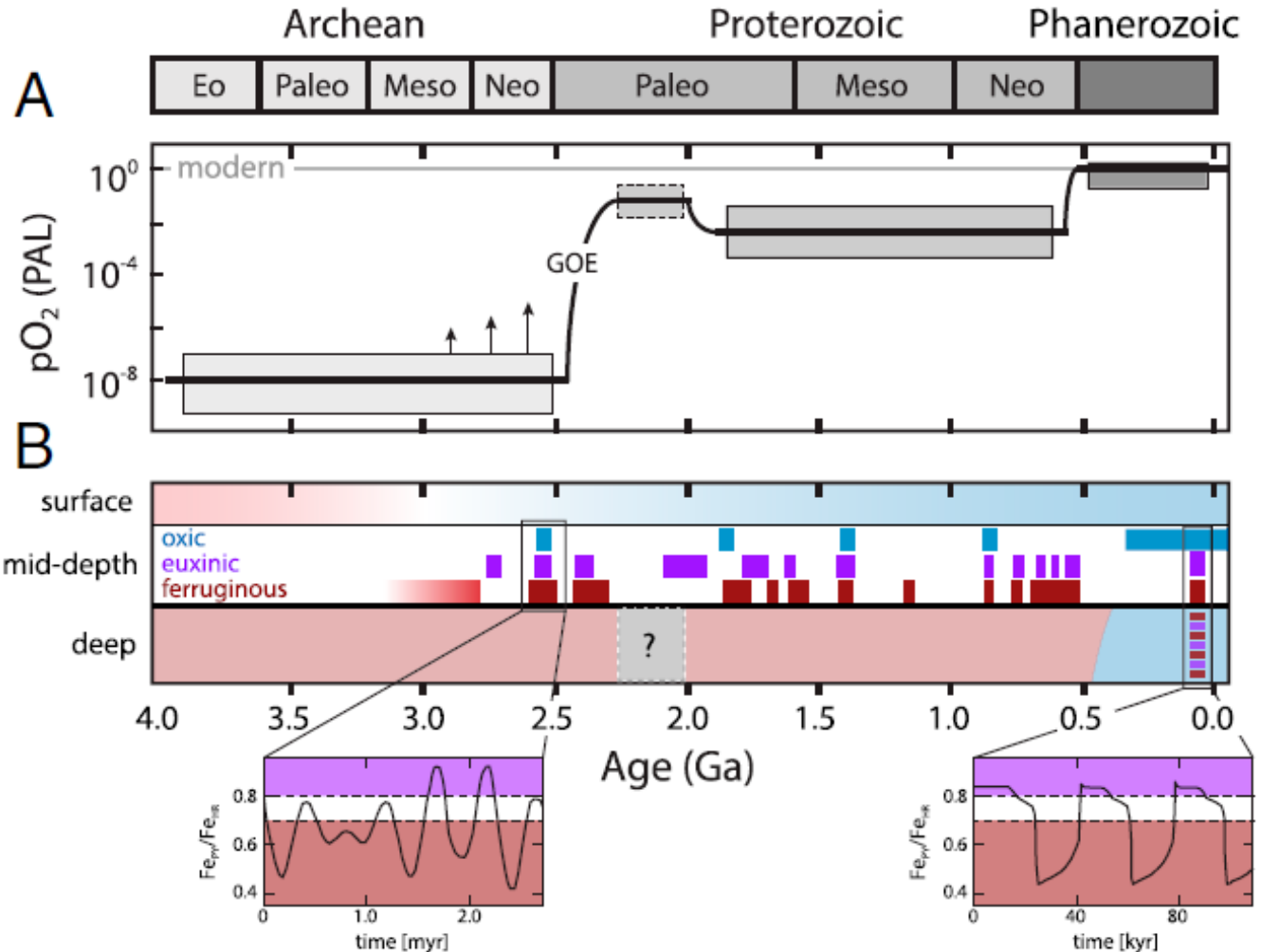

Lit.: PNAS 117 (2020) 33043

4. Phylogeny

Key Points so far

- **Many (transition) metals are essential for life**
- **Evolution is driven by presence or absence of transition metals**
- **Organisms make economic use of available resources, but also have developed mechanisms to accumulate certain elements**
- **Despite the low amount of metal ions present in living systems, they are enormously important for virtually all life processes**
- **Both deficiency and overload / excess lead to illness**
- **Dissipation of “toxic” metals, such as Pb into the biosphere is a threat to many ecosystems**

5. Metals in Biochemistry

Essential Metals for Life (Aqueous Chemistry)

Alkaline metals	Na, K	readily soluble in water, acids, and bases
Alkaline earth metals	Mg, Ca	readily soluble in acids
Main group metals	Sn, Se	relatively poor solubility
Transition metals	V, Cr, Mn, Fe, Co, Ni, Cu, Zn, Mo, W	moderate and variable solubility
Rare earth metals	LREE (La-Nd)? Eu?	poor solubility some hyperaccumulators known, e.g. wheat, dycranopteris (ferns)



5. Metals in Biochemistry

Functions of Metals for Life

- **Metal cations can adopt several coordination numbers**
 - bonding and activation of substrates to enhance Lewis acidity
- **Metal cations can adopt several coordination geometries**
 - fine tuning of electronic properties such as redox potentials
- **Ligands can be substituted without changing the structure**
 - fast ligand exchange, i.e. fast but unspecific catalysis
- **(Transition) metal cations can change size without changing the oxidation state**
 - changing number of ligands, activation of inactive ligands
 - high spin Fe^{2+} (78 pm) in $[\text{Fe}(\text{por})(\text{H}_2\text{O})]$ vs. low spin Fe^{2+} (55 pm) in $[\text{Fe}(\text{por})(\text{O}_2)]$
- **(Transition) metal cations can adopt many oxidation states and transfer „spin“**
 - atom transfer reactions, redox reactions, electron storage
 - activation of $^3\text{O}_2$ (triplet)

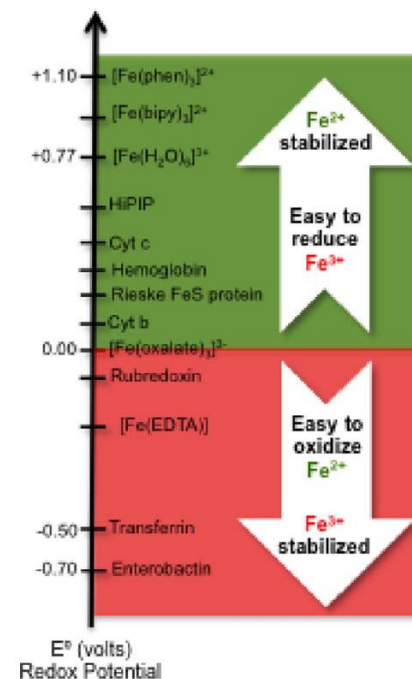

5. Metals in Biochemistry

Functions of Metals for Life: Transfer of Spin for the Activation of Oxygen

Most chemical reactions between organic molecules and oxygen are „forbidden“ and thus very slow:

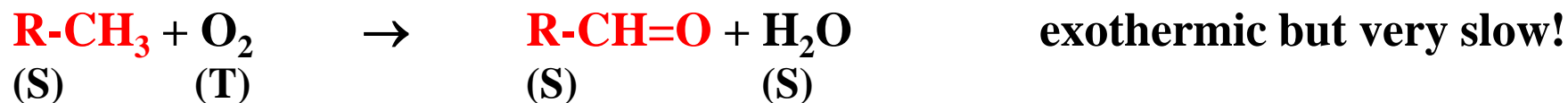

Activation of $^3\text{O}_2$ (triplet) possible by spin transfer to a metal cation:

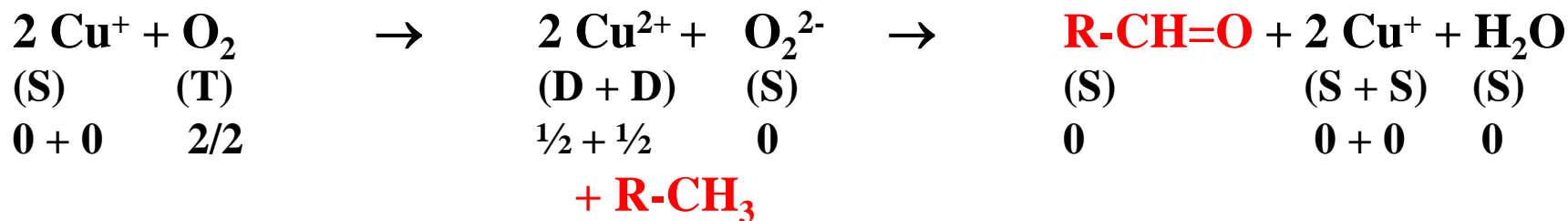

→ Metals eases spin-exchange → catalysis of “spin-forbidden” chemical reactions

5. Metals in Biochemistry

Biomolecules Comprising Metal Ions

Structural proteins

- Protein structure Ca, Zn
- Scaffolding functions Mg, Ca

Transportation and storage proteins

- e⁻-transport Fe, Cu
- O₂-transport V, Fe, Cu
- Mⁿ⁺-transport Fe, Zn

Enzymes

- Hydrolases Mg, Zn
- Oxidoreductases V, Cr, Mn, Fe, Co, Ni, Cu, Mo, W
- Isomerases/synthetases Co

Non-enzymes

- M-transport Na, K, Fe
- Energy conversion Mg
- Photosynthesis Mg

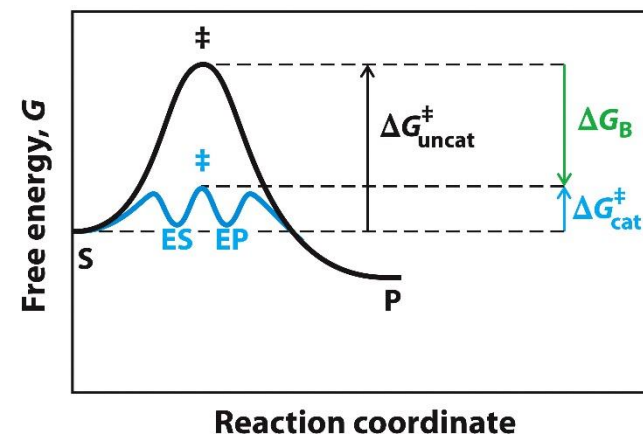

5. Metals in Biochemistry

The Alkaline Metal Cations Na⁺ and K⁺

Functions in biochemistry

- Maintenance of membrane potentials through concentration gradients of Na⁺ and K⁺ in cooperation with Cl⁻ and Ca²⁺ via the (muscular) cell membrane ⇒ signal transmission, kidney function
- Ion transport occurs via ion channels (passive or active)

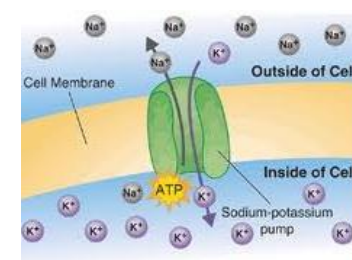
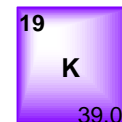

Ion	Extracell. [mM]	Intracell. [mM]	Ratio	Membrane potential [mV]
Na ⁺	145	12	12	+68
K ⁺	4	155	0.026	-99
Cl ⁻	1.5	< 10 ⁻⁷	>15000	> +128
Ca ²⁺	123	4.2	30	-90

Membrane potential:

$$E = RT/zF \cdot \ln[c(M^{n+})_{ec}/c(M^{n+})_{ic}]$$

with $F = \text{Faraday constant} = 96485 \text{ As/mol}$, $T = 310 \text{ K}$

Free enthalpy:

$$\Delta G = -z \cdot F \cdot E$$

5. Metals in Biochemistry

The Alkaline Metal Cations Na^+ and K^+

Na^+ functions (in extracellular fluid)

- Electrical impulses along nerve systems (see above)
- Osmotic balance „sodium pump”
- Acid-base balance
- Conformation of proteins and nucleic acids

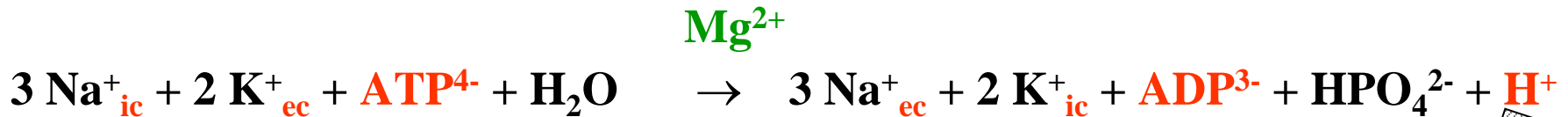

K^+ functions (in intracellular fluid)

- Enzyme activator
- Conformation of proteins and RNA
- Secretion of gastric acid
- Transmembrane potentials
- Cyclic antibiotics: Valinomycin, Monactin, Nonactin

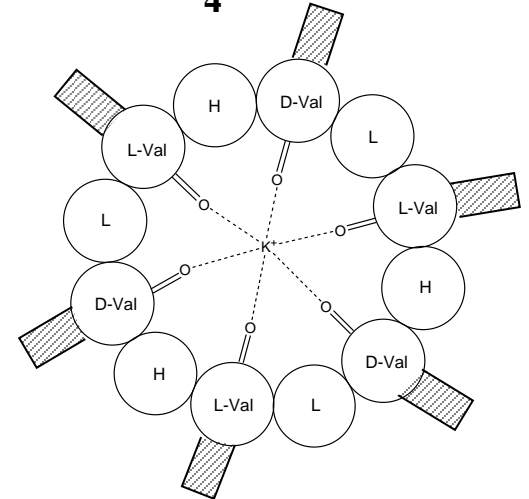

5. Metals in Biochemistry

Magnesium Cations

- Metal centres in chlorophyll (photosynthesis)
- In active centres of ATPases and other enzymes
⇒ PCR (Polymerase Chain Reaction)
- Intracellular fluids

Calcium Cations

- Extracellular fluids
- Of importance for blood coagulation and muscle contraction
- Exoskeleton: CaCO_3
 - Mollusca (scallops, snails)
 - Cnidaria (corals, jelly fish)
- Endoskeletons: $\text{Ca}_5(\text{PO}_4)_3\text{X}$ with $\text{X} = \text{OH}, \text{F}, \text{Cl}$
 - Chordata or vertebrata (vertebrates)
 - Cephalopoda

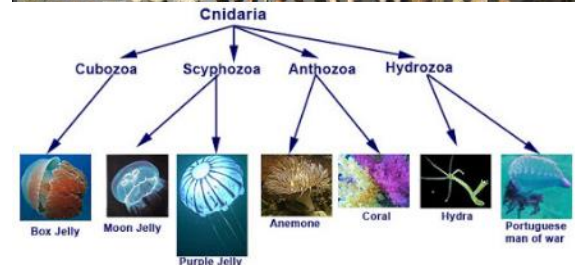
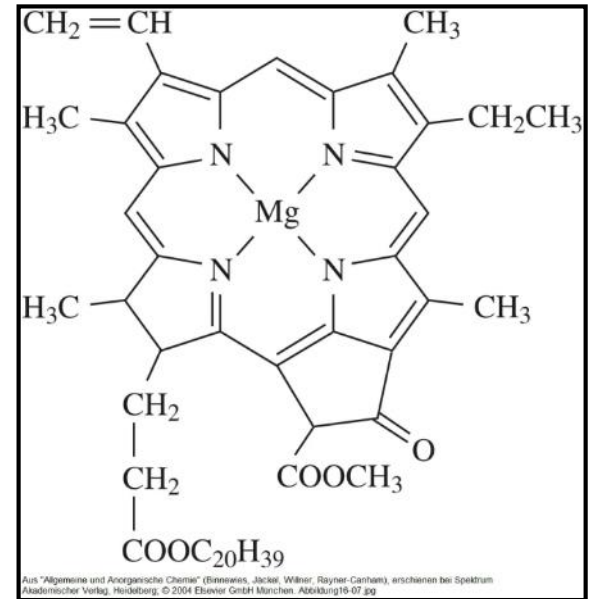

5. Metals in Biochemistry

Oxidation States of Transitions Metals (TM)

3d-Elements	Sc +3	Ti +2, +3, +4	V +2,+3, +4, +5	Cr +2, +3, +6	Mn +2, +3 +4, +7	Fe +2, +3	Co +2, +3	Ni +2	Cu +1, +2	Zn +2
4d-Elements	Y +3	Zr +4	Nb +5	Mo +4, +6	Tc* +7	Ru +2, +3, +4	Rh +3	Pd +2	Ag +1, +2	Cd +2
5d-Elements	La +3	Hf +4	Ta +5	W +4, +6	Re +4, +7	Os +4, +8	Ir +3, +4	Pt +2, +4	Au +1, +3	Hg +1, +2

- All TM, which are sufficiently abundant within earth's crust and possess relatively stable oxidation states, are readily soluble and thus biologically available and are of importance as trace elements
- Many metals in high oxidation states form poorly soluble oxides \Rightarrow TiO_2 , ZrO_2 , HfO_2 , Nb_2O_5 , Ta_2O_5 , MnO_2 , RuO_2 , OsO_4 , IrO_2
- Metals, that are most stable at high oxidation states, occur in the earth's crust as poorly soluble oxides and are thus not biologically available (Ti, Zr, Hf)

5. Metals in Biochemistry

Oxidation States of 3d-Metals in Acidic Solution (Frost-Diagram)

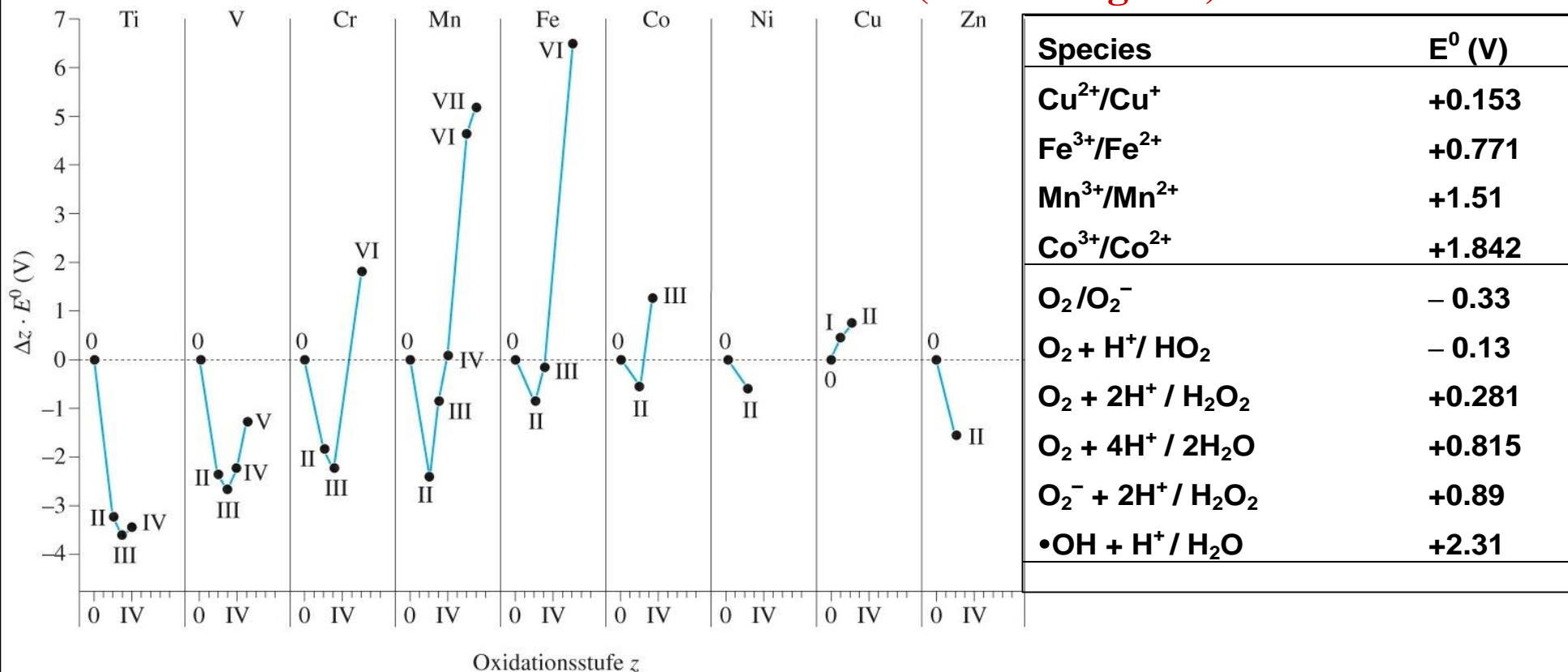

- The metals are reducing agents, with titanium being the strongest reducing agent and copper in cationic form as (half) noble metal being slightly oxidising.
- Cr^{VI} is a strong and Mn^{VI} , Mn^{VII} and Fe^{VI} are extremely strong oxidising agents
- Relatively stable oxidation states: $\text{Ti}^{\text{III/IV}}$, $\text{V}^{\text{III/IV}}$, Cr^{III} , $\text{Mn}^{\text{II/III/IV}}$, $\text{Fe}^{\text{II/III}}$, $\text{Co}^{\text{II/III}}$, Ni^{II} , $\text{Cu}^{\text{I/II}}$, Zn^{II}

5. Metals in Biochemistry

Mn²⁺-Ions: Labile Complexes with Highly Variable Coordination Sphere

Properties	Typical Values / Products
Ionic radius/Å ^[coordination]	0.97 ^[hs-6o]
Configuration	[Ar]3d ⁵
CFSE/Dq	0
Preferred coordination	(N,O) ₆
Species at pH 7	[Mn(H ₂ O) ₆] ²⁺
pK _A of aqua-ion	10.6
+ NH ₃	Mn(OH) ₂
+ H ₂ S + metal salt/NH ₃ -solution	MnS
+ CN ⁻	ls-[Mn(CN) ₆] ⁴⁻



5. Metals in Biochemistry

Mn³⁺-Ions: Complexes with Strong Distortion (Jahn-Teller-Ion)

Properties	Typical Values / Products
Ionic radius/Å ^[coordination]	0.785 ^[hs-6]
Configuration	[Ar]3d ⁴
CFSE/Dq	> 0
Preferred coordination	O ₄₋₆ , JT-distorted
Species at pH 7	Mn(OH) ₃ ; MnOOH
pK _A of aqua-ion	0.7
+ NH ₃	Mn(OH) ₃ , MnOOH?
+ H ₂ S + metal salt/NH ₃ -solution	?
+ CN ⁻	ls-[Mn(CN) ₆] ³⁻

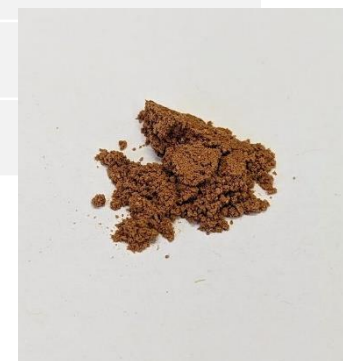

5. Metals in Biochemistry

Mn⁴⁺-Ions: Kinetically Stable Complexes with High Oxidation Strength

Properties	Typical Values / Products
Ionic radius/Å ^[coordination]	0.67 ^[60]
Configuration	[Ar]3d ³
CFSE/Dq	-12
Preferred coordination	O ₆
Species at pH 7	MnO(OH) ₂ , MnO ₂
pK _A of aqua-ion	-
+ NH ₃	-?
+ H ₂ S + metal salt/NH ₃ -solution	?
+ CN ⁻	-?



5. Metals in Biochemistry

Fe²⁺-Ions: Predominantly High-Spin Complexes

Properties	Typical Values / Products
Ionic radius/Å ^[coordination]	0.77 ^[hs-4t] , 0.78 ^[hs-4sp] , 0.92 ^[hs-6o] , 0.75 ^[ls-6o]
Configuration	[Ar]3d ⁶
CFSE/Dq	hs: -4, ls: -24
Preferred coordination	hs: (N,O) ₅₋₆ , S ₄ , ls: N ₆ , N ₅ (O,S)
Dissolved species at pH 7	[Fe(H ₂ O) ₅₋₆] ²⁺
pK _A of aqua-ion	9.5
+ NH ₃	almost [Fe(NH ₃) ₄₋₆] ²⁺ , Fe(OH) ₂
+ H ₂ S + metal salt/NH ₃ -solution	FeS
+ CN ⁻	[Fe(CN) ₆] ⁴⁻



Zu "Allgemeine und Anorganische Chemie" (Binnemans, Jöckel, Wilber, Farnke-Centiani), erschienen bei Spektrum Akademischer Verlag, Heidelberg. © 2004 Elsevier GmbH München. FotID:047100.jpg

5. Metals in Biochemistry

Fe³⁺-Ions: Formation of Poorly Soluble Fe(OH)₃ Favours the Formation of Highly Stable Complexes

Properties	Typical Values / Products
Ionic radius/Å ^[coordination]	0.63 ^[hs-4t] , 0.785 ^[hs-6o] , 0.69 ^[ls-6o]
Configuration	[Ar]3d ⁵
CFSE/Dq	hs: 0, [ls-6o]: -20
Preferred coordination	hs: O ₆ , ls: (N,O) ₆
Dissolved species at pH 7	Fe(OH) ₃
pK _A of aqua-ion	2.2
+ NH ₃	Fe(OH) ₃
+ H ₂ S + metal salt/NH ₃ -solution	Fe(OH) ₃
+ CN ⁻	ls-[Fe(CN) ₆] ³⁻



Zi: "Allgemeine und Anorganische Chemie" (Broschura, 4. Aufl., Walter, Rayner-Caplan), erschienen bei Spektrum Akademischer Verlag, Heidelberg, © 2004 Elsevier GmbH München, FeCl3.jpg

5. Metals in Biochemistry

Ni²⁺-Ions: Kinetically Stable Octahedral Complexes

Properties	Typical Values / Products
Ionic radius/Å ^[coordination]	0.69 ^[4] , 0.83 ^[6o]
Configuration	[Ar]3d ⁸
CFSE/Dq	-12
Preferred coordination	(N,O) ₆
Solution at pH 7	[Ni(H ₂ O) ₆] ²⁺
pK _A of aqua-ion	9.9
+ NH ₃	[Ni(NH ₃) ₆] ²⁺
+ H ₂ S + metal salt/NH ₃ -solution	NiS
+ CN ⁻	[Ni(CN) ₄] ²⁻ , [Ni(CN) ₅] ³⁻



Zu "Abgrenzung und Anorganische Chemie" (Schnitzler, Jäckel, Wilber, Rayner-Cunha) erschienen bei Spektrum Akademischer Verlag, Heidelberg, © 2004. Freese GmbH/Bamberg, 0107090504.jpg

5. Metals in Biochemistry

Cu⁺-Ions: Kinetically Labile Complexes of Tetrahedral Structure

Properties	Typical Values / Products
Ionic radius/Å ^[coordination]	0.74 ^[4t] , 0.91 ^[6o]
Configuration	[Ar]3d ¹⁰
CFSE/Dq	0
Preferred coordination	N ₄ , S ₄
Solution at pH 7	Disproportion
pK _A of aqua-ion	–
E ^{0'}	0.1 V
+ NH ₃	[Cu(NH ₃) ₄] ⁺
+ H ₂ S + metal salt/NH ₃ -solution	Cu ₂ S
+ CN ⁻	[Cu(CN) ₄] ³⁻

5. Metals in Biochemistry

Cu²⁺-Ions: Complexes with Strong Distortion (Jahn-Teller-Ion)

Properties	Typical Values / Products
Ionic radius/Å ^[coordination]	0.71 ^[4] , 0.79 ^[5] , 0.87 ^[60]
Configuration	[Ar]3d ⁹
CFSE/Dq	> 0
Preferred coordination	N/O ₄₋₆ , JT-distorted
Solution at pH 7	[Cu(H ₂ O) ₅] ²⁺
pK _A of aqua-ion	8.0
E ^{0'}	0.1 V
+ NH ₃	[Cu(NH ₃) ₄ (H ₂ O) ₂] ²⁺
+ H ₂ S + metal salt/NH ₃ -solution	“CuS“ contains Cu ^{II} and S ²⁻ next to Cu ^I and S ₂ ²⁻
+ CN ⁻	Reduction to [Cu(CN) ₄] ³⁻

5. Metals in Biochemistry

Zn²⁺-Ions: Labile Complexes with Variable Coordination Geometry

Properties	Typical Values / Products
Ionic radius/Å ^[coordination]	0.74 ^[4t] , 0.82 ^[5] , 0.88 ^[6o]
Configuration	[Ar]3d ¹⁰
CFSE/Dq	0
Preferred coordination	N ₄ , (N,O) ₅₋₆ , S ₄
Dissolved species at pH 7	[Zn(H ₂ O) ₅₋₆] ²⁺
pK _A of aqua-ion	9.0
+ NH ₃	[Zn(NH ₃) ₄] ²⁺
+ H ₂ S + metal salt /NH ₃ -solution	ZnS
+ CN ⁻	[Zn(CN) ₄] ²⁻

5. Metals in Biochemistry

Coordination of Biochemically Relevant Metal Cations

Cation	CN	Geometry	Biochemical ligands
Na⁺	6	octahedral	O: ether, hydroxyl, carboxylate
K⁺	6-8	flexible	O: ether, hydroxyl, carboxylate
Mg²⁺	6	octahedral	O: carboxylate, phosphate
Ca²⁺	6-8	flexible	O: carboxylate, carbonyl, phosphates
Mn²⁺(d⁵)	6	octahedral	O: carboxylate, phosphates N: imidazole
Mn³⁺(d⁴)	6	tetragonal	O: carboxylate, phosphate, hydroxide
Fe²⁺(d⁶)	4	tetrahedral	S: thiolate
	6	octahedral	O: carboxylate, alkoxide, oxide, phenolates N: imidazole, porphyrin
Fe³⁺(d⁵)	4	tetrahedral	S: thiolate
	6	octahedral	O: carboxylate, alkoxide, oxide, phenolates N: imidazole, porphyrin
Co²⁺(d⁷)	6	octahedral	O, carboxylate N, imidazole

5. Metals in Biochemistry

Coordination of Biochemically Relevant Metal Cations

Cation	CN	Geometry	Biochemical ligands
Ni²⁺(d⁸)	4	square-planar	S: thiolate N: imidazole, polypyrrole
	6	octahedral	rare!
Cu⁺(d¹⁰)	4	tetrahedral	S: thiolate, thioether N: imidazole
	4	tetrahedral	S: thiolate, thioether N: imidazole
Cu²⁺(d⁹)	4	square-planar	O: carboxylate N: imidazole
	6	tetragonal (distorted octahedral)	O: carboxylate N: imidazole
	4	tetrahedral	O: carboxylate, carbonyl S: thiolate N: imidazole
Zn²⁺(d¹⁰)	4	tetrahedral	O: carboxylate, carbonyl S: thiolate N: imidazole
	5	square-pyramidal	O: carboxylate, carbonyl N: imidazole

5. Metals in Biochemistry

Kinetic Aspects – Lifetime of Aqua Ligands to Metal Bonds [s]

- Cr^{3+} forms inert complexes (like Co^{3+})
- In^{3+} , Cd^{2+} and Hg^{2+} are toxic
- Be^{2+} blocks (intoxicating) Mg^{2+} -containing enzymes

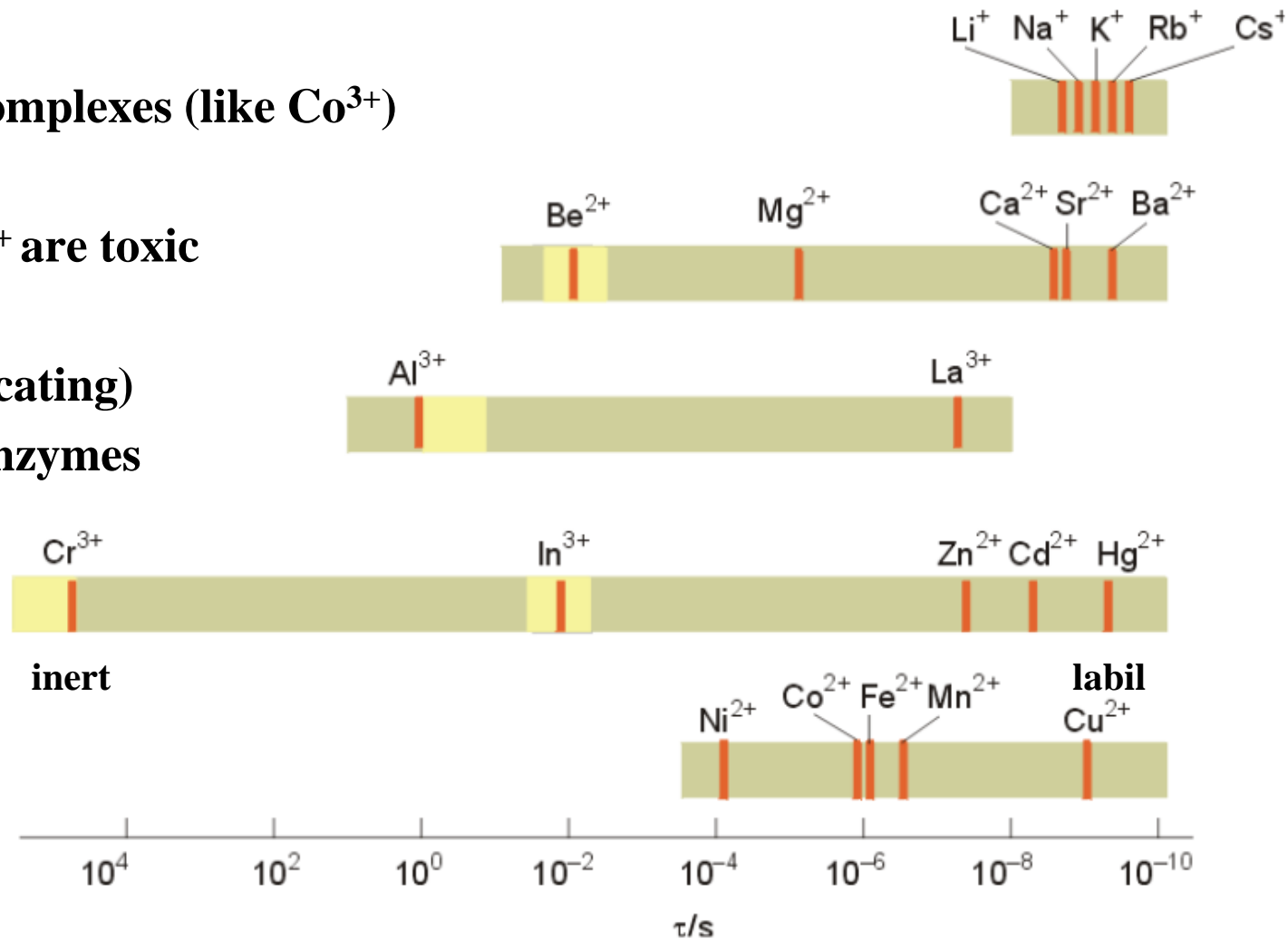

6. Ligands in Biochemistry

Small Inorganic Molecules \Rightarrow “Hard Ligands“

H_2O	Aquo (aqua)	
OH^-	Hydroxy (hydroxido)	
O^{2-}	Oxo	
$\text{CO}_2/\text{CO}_3^{2-}$	Carbonato	C source
O_2^{2-}	Peroxy	Oxidant
HO_2^-	Hydroperoxy	Oxidant
O_2^-	Superoxy	Radical
O_2	Dioxygenyl	Radical
NO	Nitrosyl	Radical
NO_2	Nitrito	Radical
CO	Carbonyl	Strong bonding to Fe^{2+}
S^{2-}	Sulfido	Strong bonding to Fe^{2+}
CN^-	Cyanido	Strong bonding to Fe^{2+}
OCN^-	Cyanato	Strong bonding to Fe^{2+}
SCN^-	Thiocyanato	Strong bonding to Fe^{2+}
N_3^-	Azido	Strong bonding to Fe^{2+}
$\text{N}=\text{C}=\text{N}^{2-}$	Cyanamide	Strong binding to Ca^{2+}, Zn^{2+}

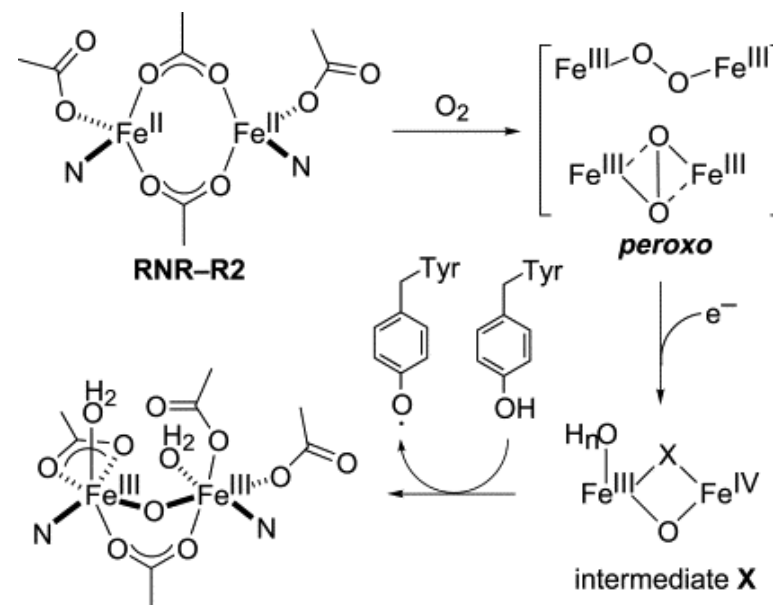

CaCN₂ as a fertiliser

6. Ligands in Biochemistry

Polypeptides and the Peptide Bond $R-NH-CO-R'$ \Rightarrow "Hard Ligands"

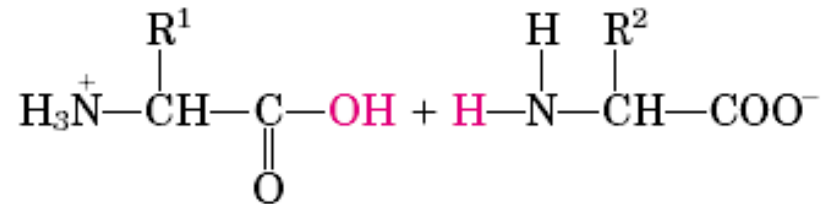
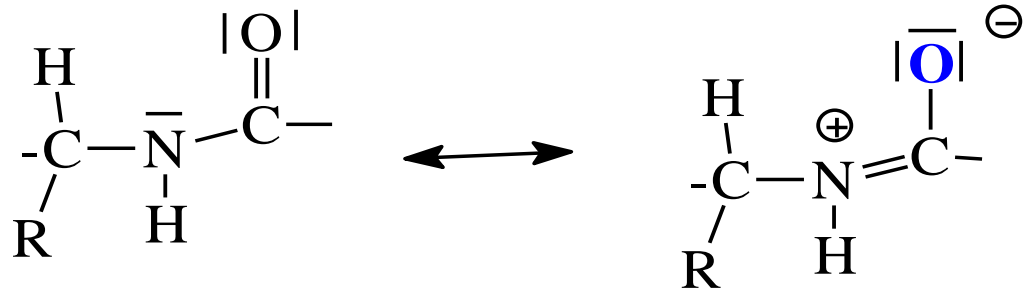

Hydrolyse



Kondensation

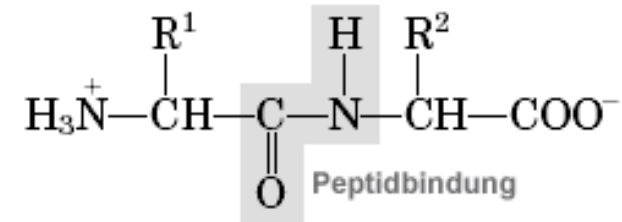

Aminosäuren in Ionenschreibweise

6. Ligands in Biochemistry

Histidine (His, H) \Rightarrow Neutral or Basic Ligands for Zn, Cu, Mn, Fe or Ni

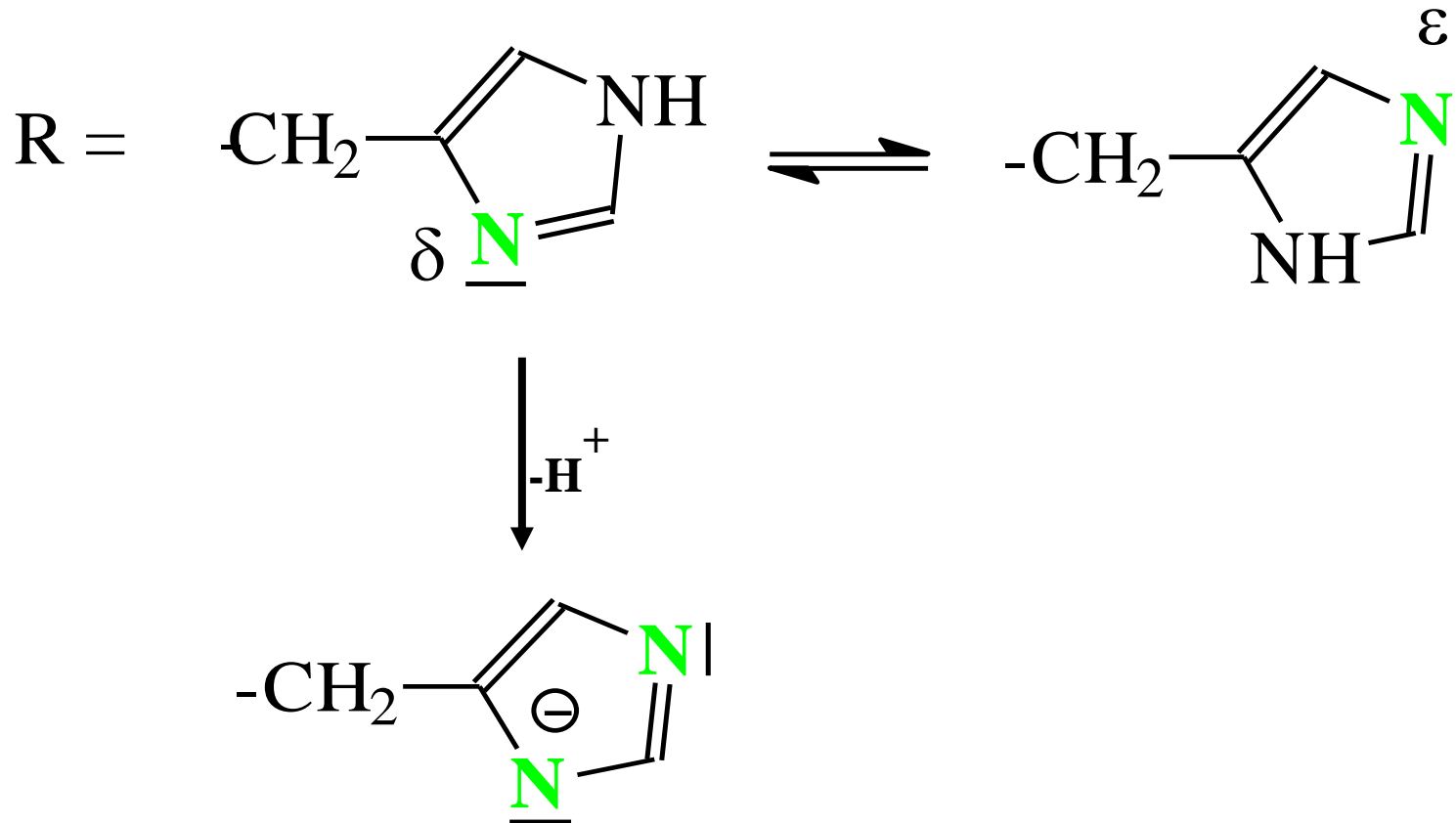

6. Ligands in Biochemistry

Aspartic Acid (Asp, D) and Glutamic Acid (Glu, E) \Rightarrow Acidic Ligands with High Affinity to Mg^{2+} and Ca^{2+}

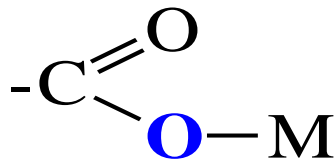
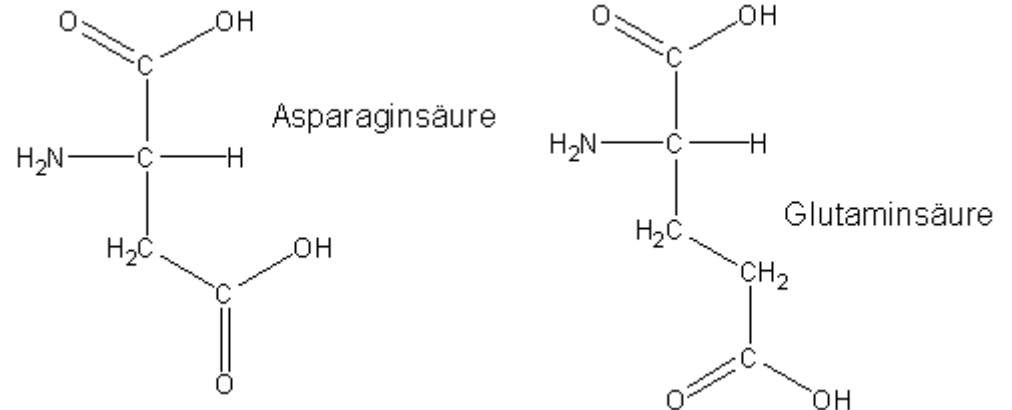

end-on
einzähnig

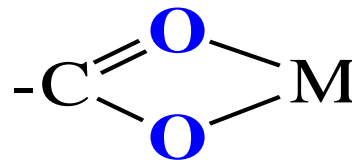

side-on
(zeizähnig,
chelartartig)

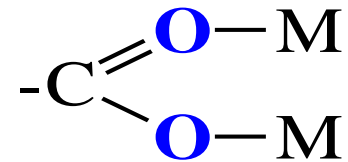

end-on
verbrücken

6. Ligands in Biochemistry

Cysteine (Cys, C) and Glutamic Acid (Glu, E)

⇒ Soft Ligands with Affinity to Zn, Cu, Fe and Ni

Organic group R

-CH₂-SH

Cysteine (Cys, C)

-CH₂-SeH

Selenocysteine (Sec, U)

-CH₂-CH₂-S-CH₃

Methionine (Met, M)

→ Relevant for protein folding

→ R-S-S-R or R-Se-Se-R bridges

6. Ligands in Biochemistry

Ascorbic Acid (Vitamin C)

- Chelating ligand, e.g. for Fe^{3+}
- Reductive, i.e. it is a redox active ligand
- Radical scavenger
- Temperature sensitive
- Acidic character: $\text{pK}_a \sim 4.1$

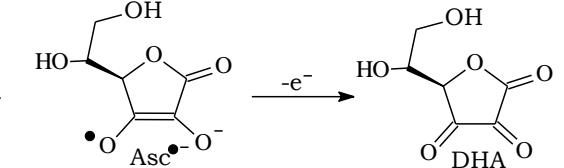
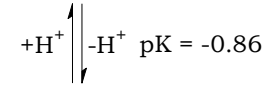
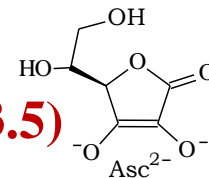
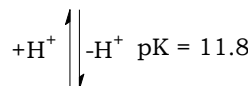
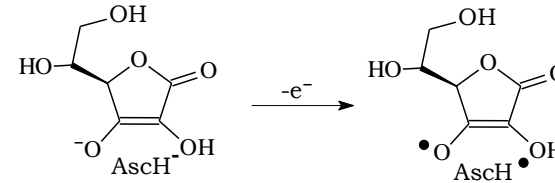
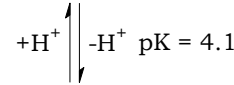
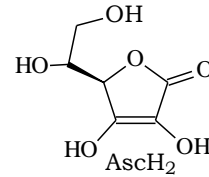

Citric Acid ($\text{pK}_a \sim 3.1$)

and Malic Acid ($\text{pK}_a \sim 3.5$)

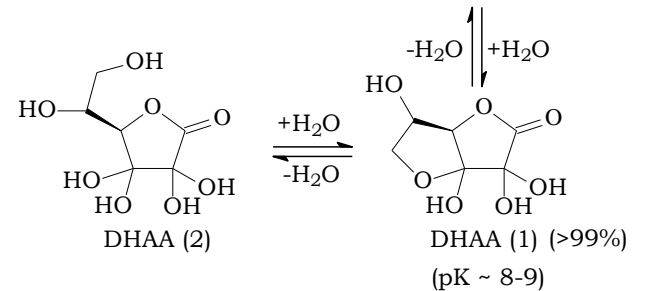
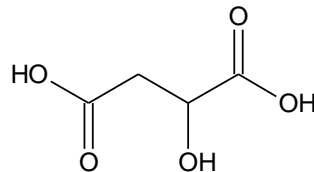
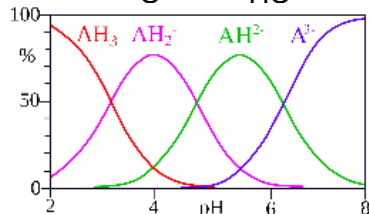
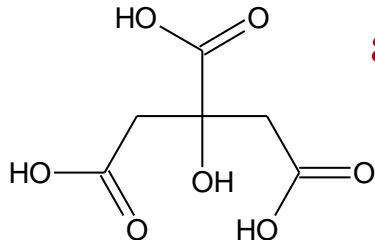

6. Ligands in Biochemistry

Siderophores \Rightarrow “Hard Ligands for Fe^{3+} ”

Catechol (o-hydroxyphenyl)

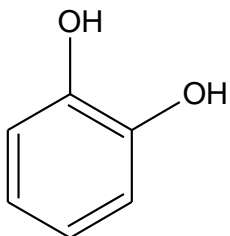

o-Quinone

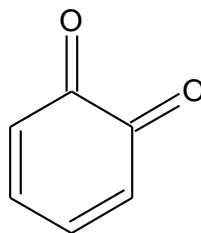

Oxidation results in semi-quinone and then o-quinone, meaning this is a redox-active Ligand, as well

Hydroquinone (p-hydroxyphenyl)

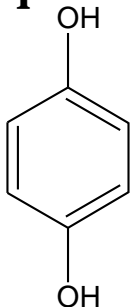

p-Quinone

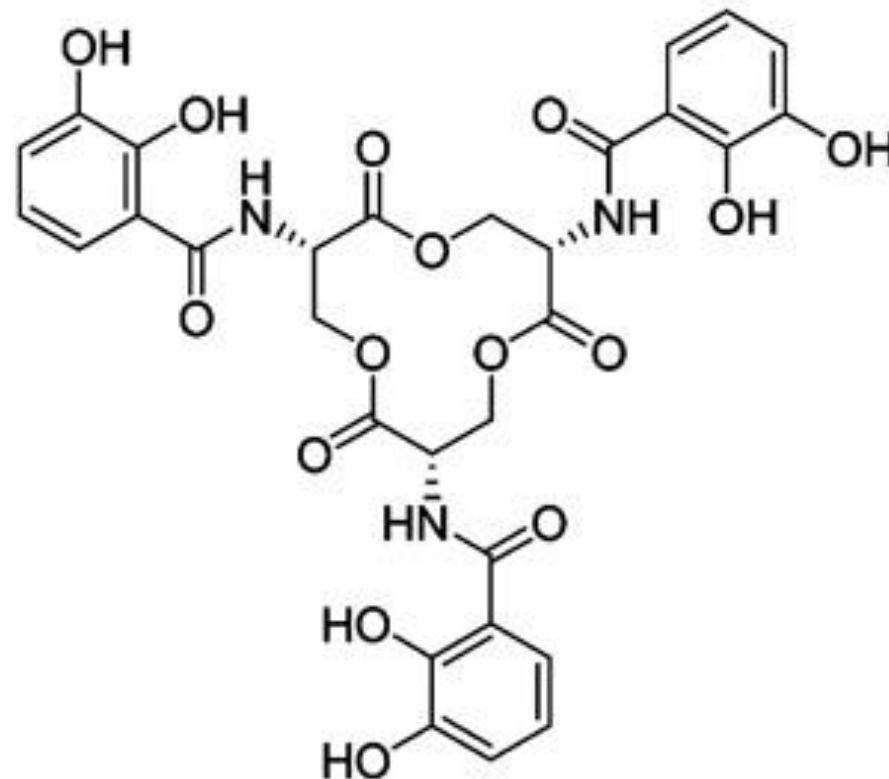
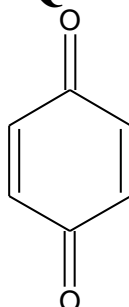

Enterobactin (E. coli)

$\log K' (\text{pH } 7) = 25$

6. Ligands in Biochemistry

Porphyrins → Macrocyclic Ligands in Heme Proteins

Hemoglobin (Hb), Myoglobin (Mb) ⇒ Fe²⁺

Chlorophyll

⇒ Mg²⁺

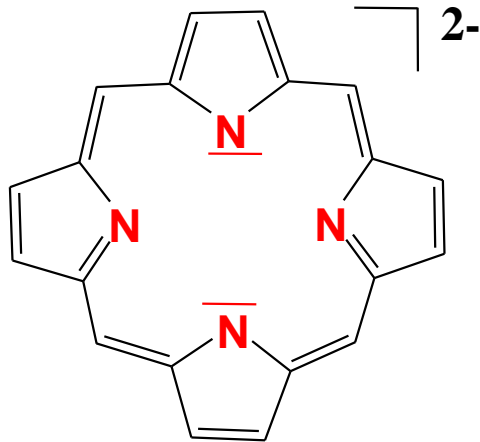

Porphyrin (Por)

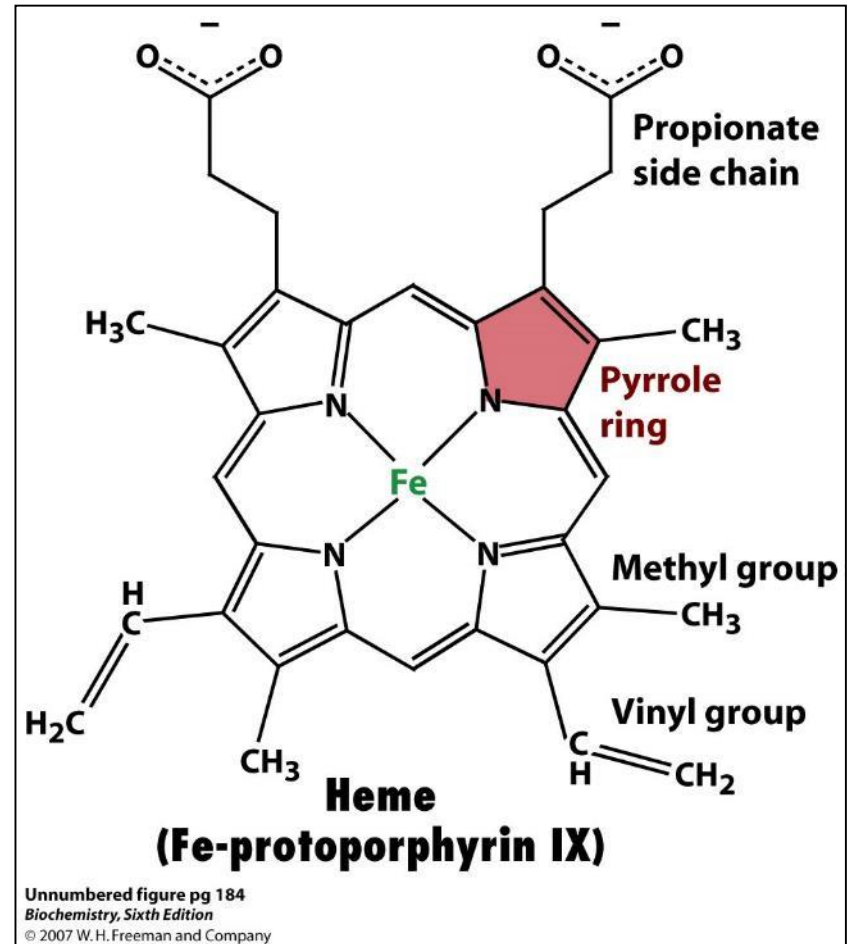

7. Principals in Coordination Chemistry

Thermodynamic Complex Stability

Complex equilibria in solution (cleavage of ligands)



Formation of a complex normally proceeds stepwise



and so on

total formation constant = $K_F = \beta_n$

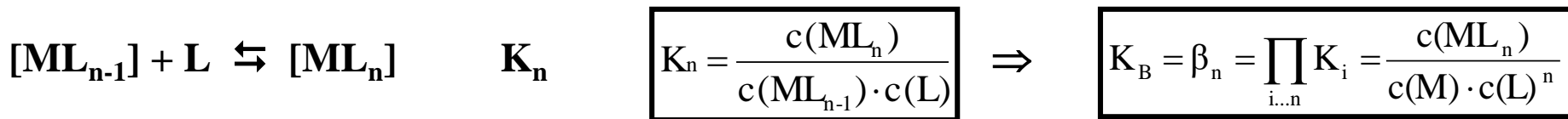

Free reaction enthalpy $\Delta G_r^0 = -R \cdot T \cdot \ln K$

7. Principals in Coordination Chemistry

Complex Stability utilizing $[\text{Cd}(\text{CN})_4]^{2-}$ as an Example

Stepwise formation of complexes with Cd^{2+} and CN^-



⇒ The complex formation constant K_n often declines with increasing degree of substitution!

Cause for that behaviour

- Sterical hindrance
- Coulomb-effect during the incorporation of charged ligands, i.e. CN^-
- Reduction of entropy through increased degree of order, i.e. $\Delta S_r^0 < 0$

7. Principals in Coordination Chemistry

Thermodynamic and Kinetic Complex Stability

The **thermodynamic stability** is described by the complex formation constant K_f or β .

The higher this number the more stable the complex is (**unstable – stable**)

Free reaction enthalpy $\Delta G_r^0 = -RT \cdot \ln K_f$

Example:

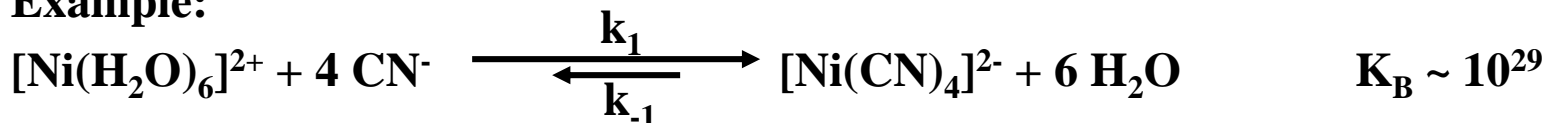

The equilibrium favours the right side, which means the complex is thermodynamically stable

Never the less ligand exchange happens fast, i.e. **kinetic complex stability** is low

(**labile – inert**)

Free activation enthalpy ΔG_r^\ddagger

Eyring-equation:

$$k = \frac{k_B \cdot T}{h} \cdot e^{\frac{-\Delta G^\ddagger}{RT}}$$



7. Principals in Coordination Chemistry

The Kinetic Complex Stability, i.e. the Reactivity of a Complex is Defined by the Structure and the Possible Reaction Pathway

Octahedral complexes

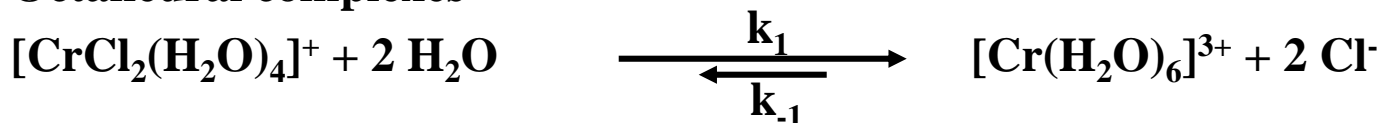

⇒ Very slow ligand exchange although the hexaquo chromium(III)-complex is more stable

Square-planar complexes

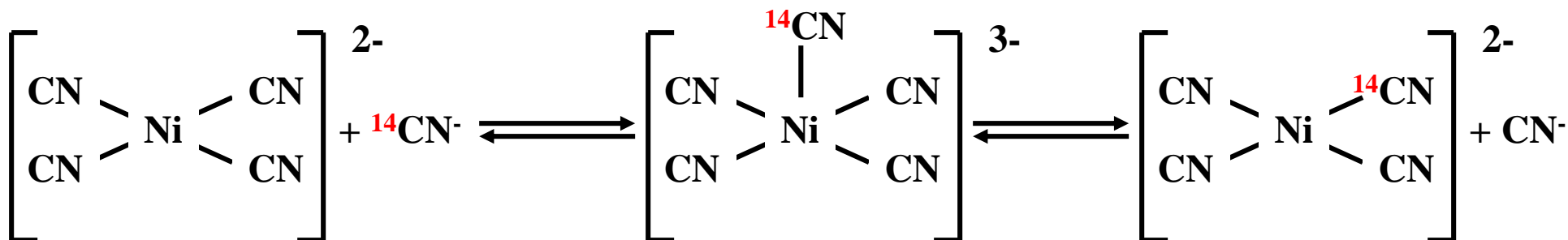

⇒ Very fast ligand exchange although the thermodynamic driving force is zero

7. Principals in Coordination Chemistry

Chelating Ligands Form Extremely Stable Complexes

Bi-dental ligands are also called chelating ligands (Greek: *chele* = claw, “chelicerata”).

The ligand takes the metal in its “claws”. If thereby (chelated) rings with 5 or 6 members are formed, they are more stable than complexes formed by mono-dental ligands, because they are favoured by enthalpy. Furthermore during the chelating process, non-chelating ligands are set free, thus increasing entropy.

⇒ The chelating effect is thus also an entropic effect!

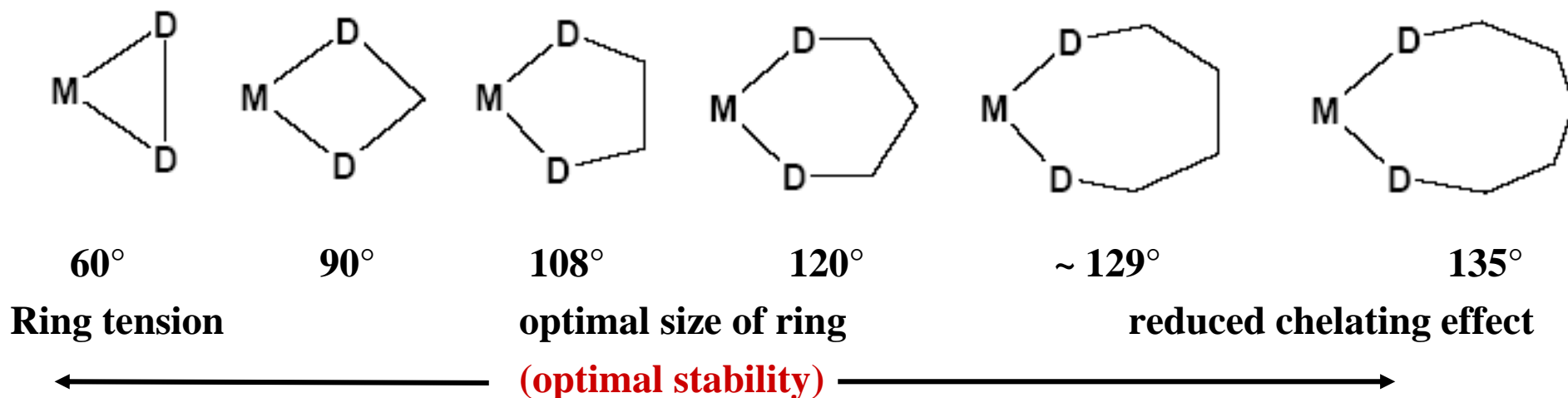

7. Principals in Coordination Chemistry

Chelating Ligands vs. Non-chelating Ligands

Complex formation by chelating ligands results in more stable complexes as in the case with mono-dental ligands



Formation of $[\text{Ni}(\text{NH}_3)_6]^{2+}$ -complex \Rightarrow particle number remains the same

Formation of $[\text{Ni}(\text{en})_3]^{2+}$ -complex \Rightarrow particle number increases $\Rightarrow \Delta S^0 > 0$

Complex formation with a chelating ligand leads to increased entropy!

ΔH is comparable for both cases

$$\Delta G^\circ = \Delta H^\circ - T\Delta S^\circ \text{ and } \Delta G^\circ = -RT \cdot \ln K_{\text{K}} \quad \text{with } K_{\text{K}} = \text{complex formation constant}$$
$$(\Delta\Delta G^\circ = 0 - T\Delta\Delta S^\circ)$$

Formation of $[\text{Ni}(\text{en})_3]^{2+} \Rightarrow$ more negative $\Delta G^\circ \Rightarrow$ **larger K_{K}**

7. Principals in Coordination Chemistry

Macrocyclic Ligands (suitable for model complexes!)

Cyclic chelating ligands, that form highly stable complexes, due to their rigidity and denticity

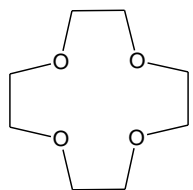

12-Crown-4

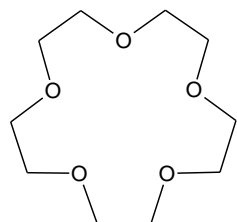

15-Crown-5

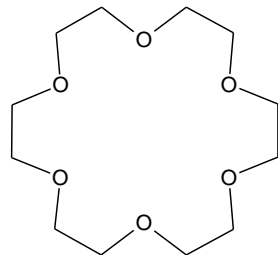

18-Crown-6

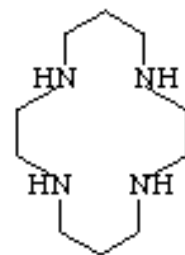

[14]aneN₄

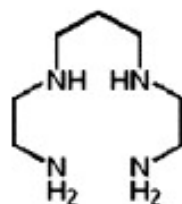
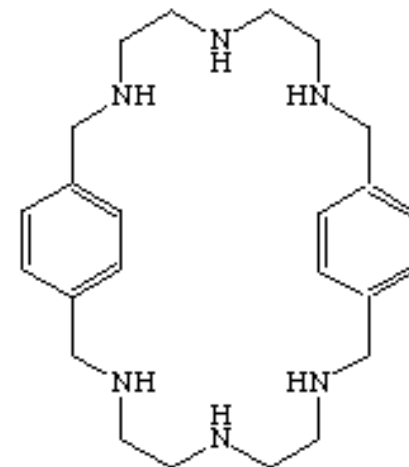
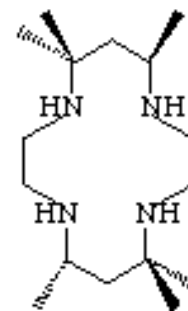

2,3,2-tet

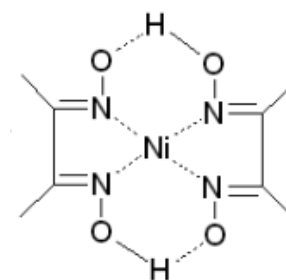

Complex

[Ni(2,3,2-tet)]²⁺

[Ni([14]aneN₄)]²⁺

[Ni(Hdmg)₂]⁰

logK_{NiL}

15.8

22.2

14.6

7. Principals in Coordination Chemistry

Dependence of Stability Constants of Metal Complexes

1. Central atoms



⇒ Correlates with decreasing cation radius / increasing ionic charge density

(Irving-Williams stability series)

2. Ligands

- Chelating effect, macrocyclic effect
- Polarizability (hard vs. soft), backbonding

Hard and Soft Acids and Bases HSAB concept (R.G. Pearson 1963)

- Metal atoms = Acids (electron acceptors)
- Ligands = Bases (electron donators)
- High stability: soft metal atoms - soft ligands
hard metal atoms - hard ligands
- Low stability: soft metal atoms - hard ligands
hard metal atoms - soft ligands

7. Principals in Coordination Chemistry

HSAB Concept: Classification of Metal Atoms (Acids) and Ligands (Bases)

	Bases	Acids
Hard	NH_3 , R-NH_2 , N_2H_4 , H_2O , OH^- , O^{2-} , R-OH , RO^- , R_2O , CO_3^{2-} , R-COO^- , NO_3^- , PO_4^{3-} , SO_4^{2-} , ClO_4^- , F^- , Cl^- <i>poorly deformable electron shells</i>	H^+ , Li^+ , Na^+ , K^+ , Ba^{2+} , Mg^{2+} , Ca^{2+} , Sr^{2+} , Ti^{3+} , Ti^{4+} , Zr^{4+} , VO^{3+} , Cr^{3+} , Cr^{6+} , Mn^{2+} , Mn^{4+} , Mn^{7+} , Fe^{3+} , Co^{3+} , Al^{3+} , Ga^{3+} , In^{3+} <i>are highly polarizing</i>
Intermediates	N_3^- , N_2 , Ph-NH_2 , NO_2^- , Br^- $\text{C}_5\text{H}_5\text{N}$, SO_3^{2-} , imidazole, aniline	Fe^{2+} , Co^{2+} , Ni^{2+} , Cu^{2+} , Zn^{2+} , Rh^{3+} , Ir^{3+} , Ru^{3+} , Sn^{2+} , Pb^{2+}
Soft	H^- , R^- , CN^- , CO , SCN^- , R_3P , RSH , R_2S , RS^- , $\text{S}_2\text{O}_3^{2-}$, I^- , RNC , $(\text{RS})_2\text{PO}_2^-$ <i>easily deformable electron shells</i>	Pd^{2+} , Pt^{2+} , Cu^+ , Ag^+ , Au^+ , Hg^+ , Hg^{2+} , Tl^+ , Me^0 , Cd^{2+} <i>are weakly polarizing</i>

7. Principals in Coordination Chemistry

Dependence of Stability Constants of Metal Complexes

3. Crystal field stabilisation energy (illustrated by pseudo-octahedral EDTA-complexes)

CFSE as a function of no of d-electrons

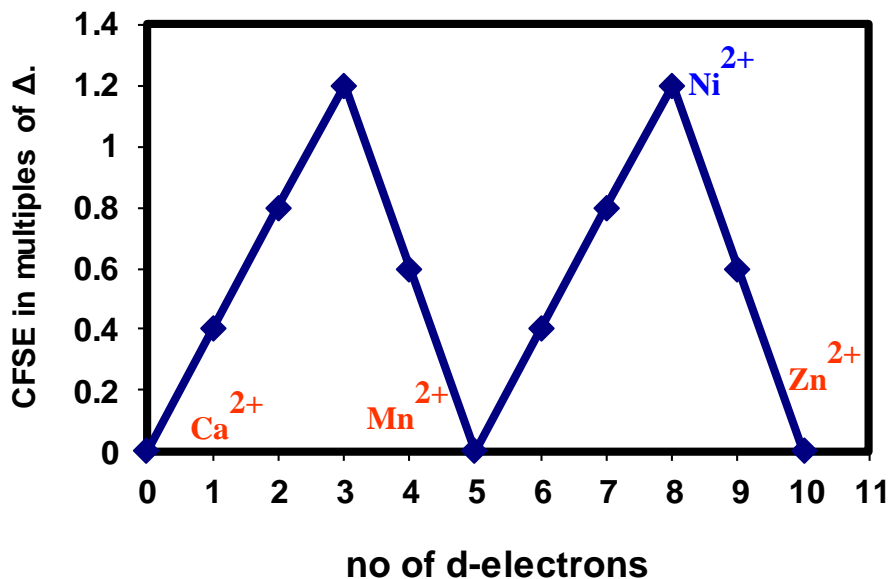

$\log K_1(\text{EDTA})$ as a function of no of d-electrons

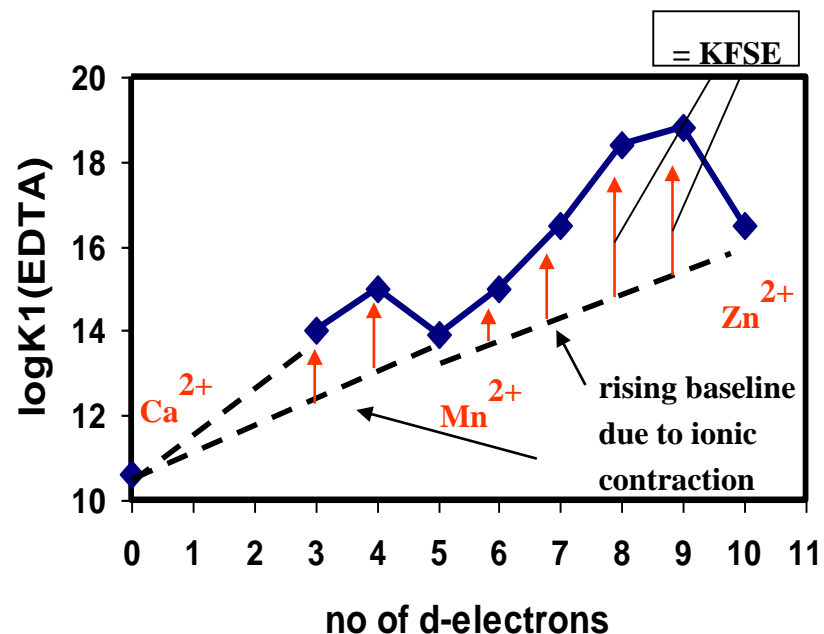

7. Principals in Coordination Chemistry

Dependence of Stability Constants of Metal Complexes

4. Coordination geometry

CN = 4: Tetrahedral coordination is favoured by d^0 , d^5 , d^7 and d^{10}

Square-planar coordination is favoured by d^8 and $d^9 \rightarrow$ cis/trans-isomerism

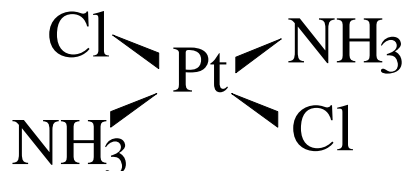
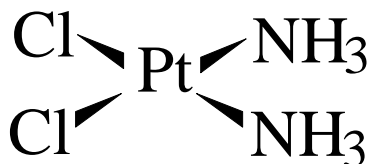

CN = 6: Octahedral more stable than trigonal-prismatic coordination

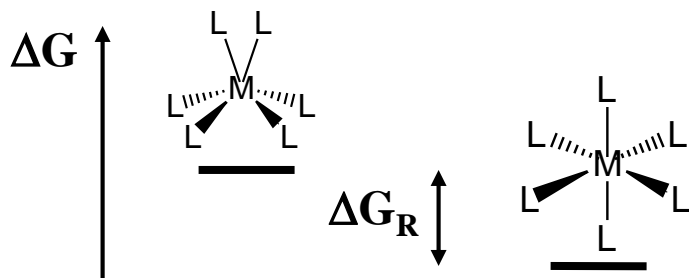

7. Principals in Coordination Chemistry

Crystal Field Splitting in Octahedral Field

$$Dq = ze^2 \cdot r^4 / (6 \cdot a \cdot R^5)$$

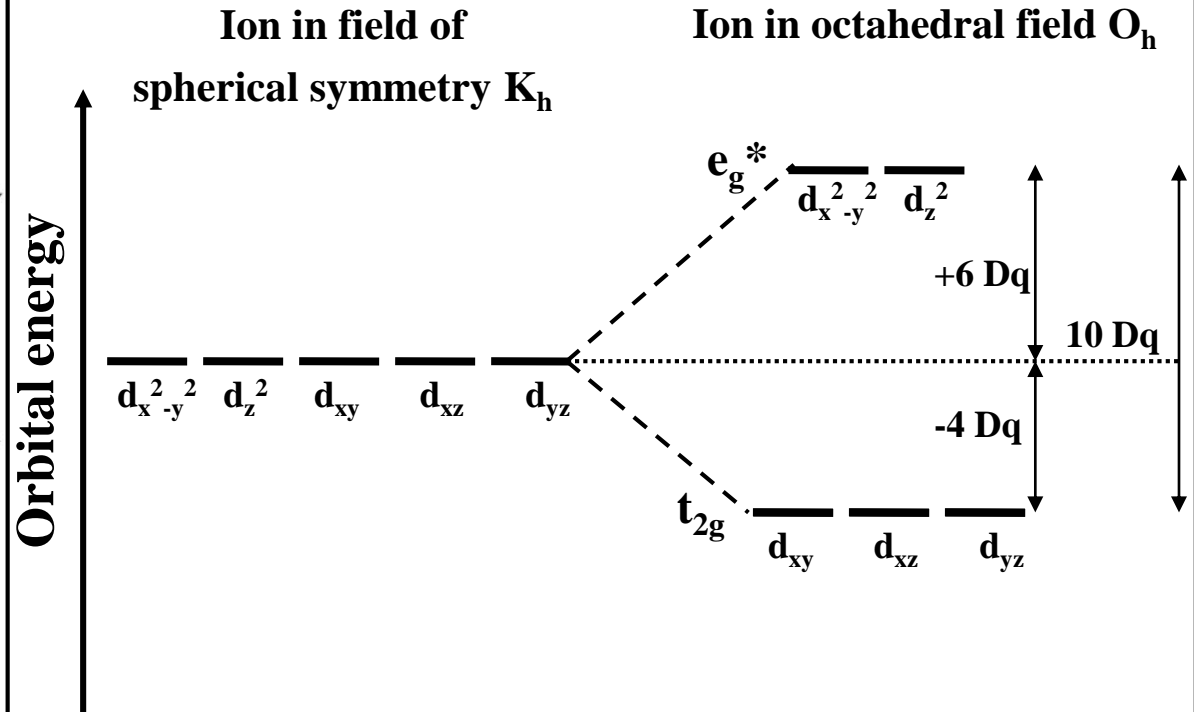
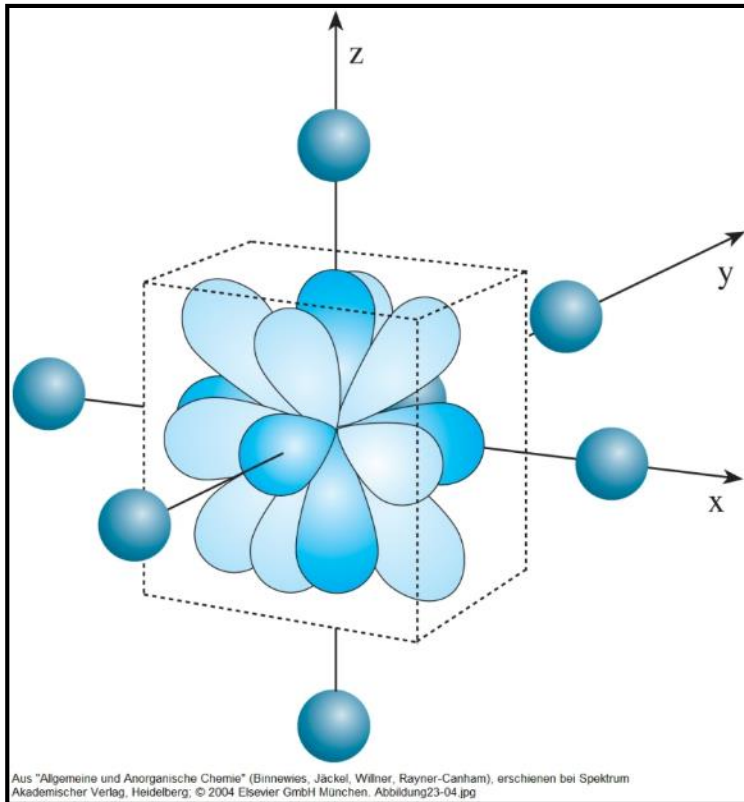

The energy gap between the t_{2g} and e_g^* -orbitals is called $10 Dq$ or Δ_o

7. Principals in Coordination Chemistry

Crystal Field Stabilisation Energy (CFSE)

Crystal field stabilisation energy in octahedral crystal field

$$\text{CFSE} = x(-4 Dq_0) + y(+6 Dq_0) + P \quad \text{with} \quad \begin{array}{l} P = \text{spin-pairing energy} \\ x = \text{number of electrons in } t_{2g} \\ y = \text{number of electrons in } e_g^* \end{array}$$

d^n	CFSE <u>high-spin</u>	CFSE <u>low-spin</u>	ΔCFSE	Examples
0	0 Dq_0	0 Dq_0	-	$\text{Sc}^{3+}, \text{Y}^{3+}, \text{Ln}^{3+}, \text{Ti}^{4+}$
1	-4 Dq_0	-4 Dq_0	-	Ti^{3+}
2	-8 Dq_0	-8 Dq_0	-	V^{3+}
3	-12 Dq_0	-12 Dq_0	-	$\text{Cr}^{3+}, \text{Mo}^{3+}, \text{W}^{3+}$
4	-6 Dq_0	-16 $Dq_0 + 1 P$	-10 $Dq_0 + 1 P$	Mn^{3+}
5	0 Dq_0	-20 $Dq_0 + 2 P$	-20 $Dq_0 + 2 P$	$\text{Mn}^{2+}, \text{Fe}^{3+}, \text{Ru}^{3+}$
6	-4 $Dq_0 + 1 P$	-24 $Dq_0 + 3 P$	-20 $Dq_0 + 2 P$	$\text{Fe}^{2+}, \text{Co}^{3+}, \text{Ru}^{2+}, \text{Ir}^{3+}$
7	-8 $Dq_0 + 2 P$	-18 $Dq_0 + 3 P$	-10 $Dq_0 + 1 P$	Co^{2+}
8	-12 $Dq_0 + 3 P$	-12 $Dq_0 + 3 P$	-	Ni^{2+}
9	-6 $Dq_0 + 4 P$	-6 $Dq_0 + 4 P$	-	Cu^{2+}
10	0 $Dq_0 + 5 P$	0 $Dq_0 + 5 P$	-	$\text{Cu}^+, \text{Zn}^{2+}$

Low-spin complexes are favoured if $10 Dq > P \Rightarrow \Delta_0\text{total}$ is always negative!

7. Principals in Coordination Chemistry

Spin-Pairing Energy (P)

$$P_{\text{total}} = P_c + P_e \text{ with}$$

P_c = Coulomb's repulsive energy





Electronic repulsion in an orbital

3d > 4d > 5d, since orbitals become ever more diffuse

P_e = Loss of exchange energy (quantum mechanical part)

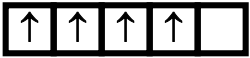
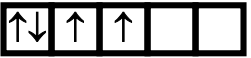
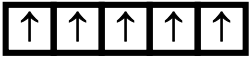
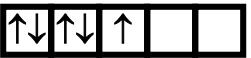
~ number of possibilities n to arrange electrons with parallel spin in pairs

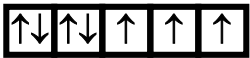
$$P_e = [n(n-1)/2] * E_{\text{ex}} \text{ with } E_{\text{ex}} = \text{average exchange energy}$$

d^n	P_e high-spin [E_{ex}]	P_e low-spin [E_{ex}]	ΔP_e [E_{ex}]	ΔCFSE	ΔP_e per 10 Dq_0 [E_{ex}]	
4	 $4(4-1)/2 = 6$	 $3(3-1)/2 = 3$		3	-10 Dq_0	3
5	 $5(5-1)/2 = 10$	 $3(3-1)/2 + 2(2-1)/2 = 4$		6	-20 Dq_0	3
6	 $5(5-1)/2 = 10$	 $3(3-1)/2 + 3(3-1)/2 = 6$		4	-20 Dq_0	2
7	 $5(5-1)/2 + 2(2-1)/2 = 11$	 $4(4-1)/2 + 3(3-1)/2 = 9$		2	-10 Dq_0	2

7. Principals in Coordination Chemistry

Spin-Pairing Energy – Relevance for Biochemically Important TM-Cations

- For ions with d^4 - or d^5 -configuration the loss of exchange energy with regard to $10 Dq$ is most pronounced
- Ions with d^6 - or d^7 -configuration form low-spin complexes even for weak ligand field:
 P_{ges} for $d^6 < d^7 < d^4 < d^5$
- P_{ges} for d^7 -ions is somewhat higher than for d^6 -ions, since P_c is greater

d^n	Free Ion	P_c [cm^{-1}]	P_{ex} [cm^{-1}]	P_{ges} [cm^{-1}]	
4	Cr^{2+}	5950	14475	20425	Numbers according to L.E. Orgel J. Phys. Chem. 23 (1955) 1819
	Mn^{3+}	7350	17865	25125	
5	Mn^{2+}	7610	16215	23825	J. Inorg. Nucl. Chem. 2 (1956) 229
	Fe^{3+}	10050	19825	29875	
6	Fe^{2+}	7460	11690	19150	Numbers for complexed ions are 15-30% smaller due to the nephelauxetic effect of the ligands!
	Co^{3+}	9450	14175	23625	
7	Co^{2+}	8400	12400	20800	

**Fe^{2+} forms low-spin complexes, even in weak crystal fields,
whereas Fe^{3+} often forms high-spin complexes despite its higher ionic charge!**

7. Principals in Coordination Chemistry

Crystal Field Splitting in Octahedral Field

Cause: Degeneracy of electronic states

Jahn-Teller-Theorem (Hermann Arthur Jahn and Edward Teller, 1937)

“Every non-linear molecule, which is in an electronically degenerate state, is prone to distortion lowering the symmetry and thus counteracting the electronic degeneracy“
 \Rightarrow great energy gain for d^4 (h.s.), d^7 (l.s.), and d^9 -configurations!

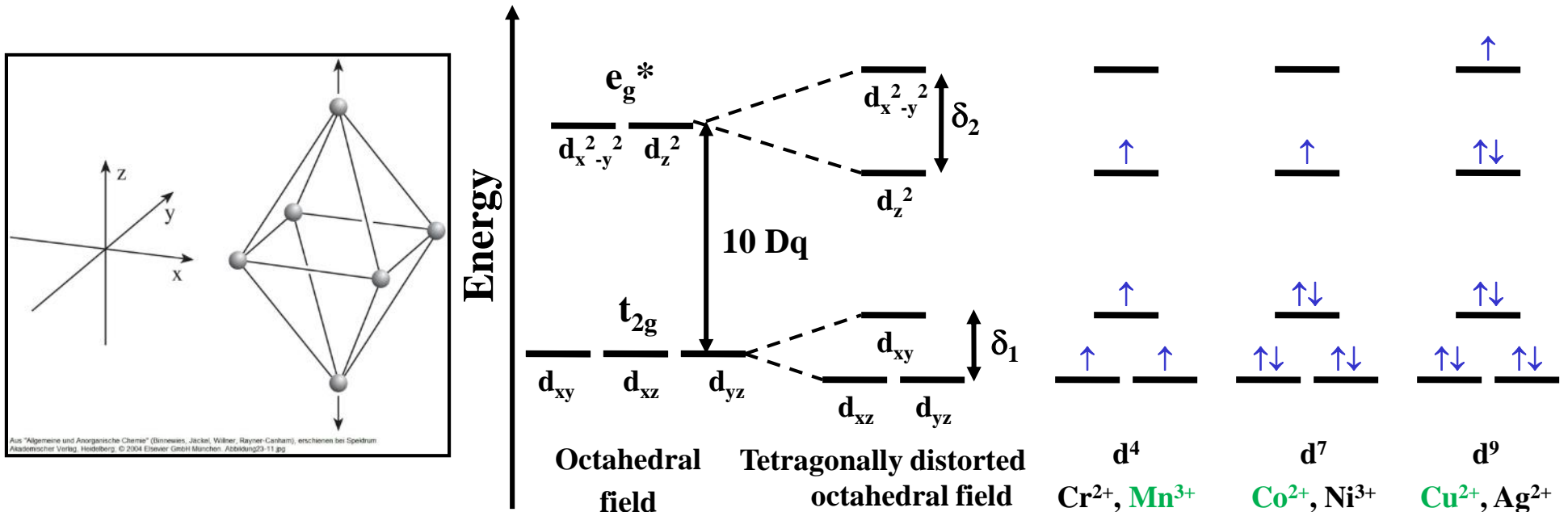

7. Principals in Coordination Chemistry

Crystal Field Splitting in Tetragonally Distorted Octahedral Field

Tetragonally distorted octahedral crystal field as a consequence of the Jahn-Teller effect

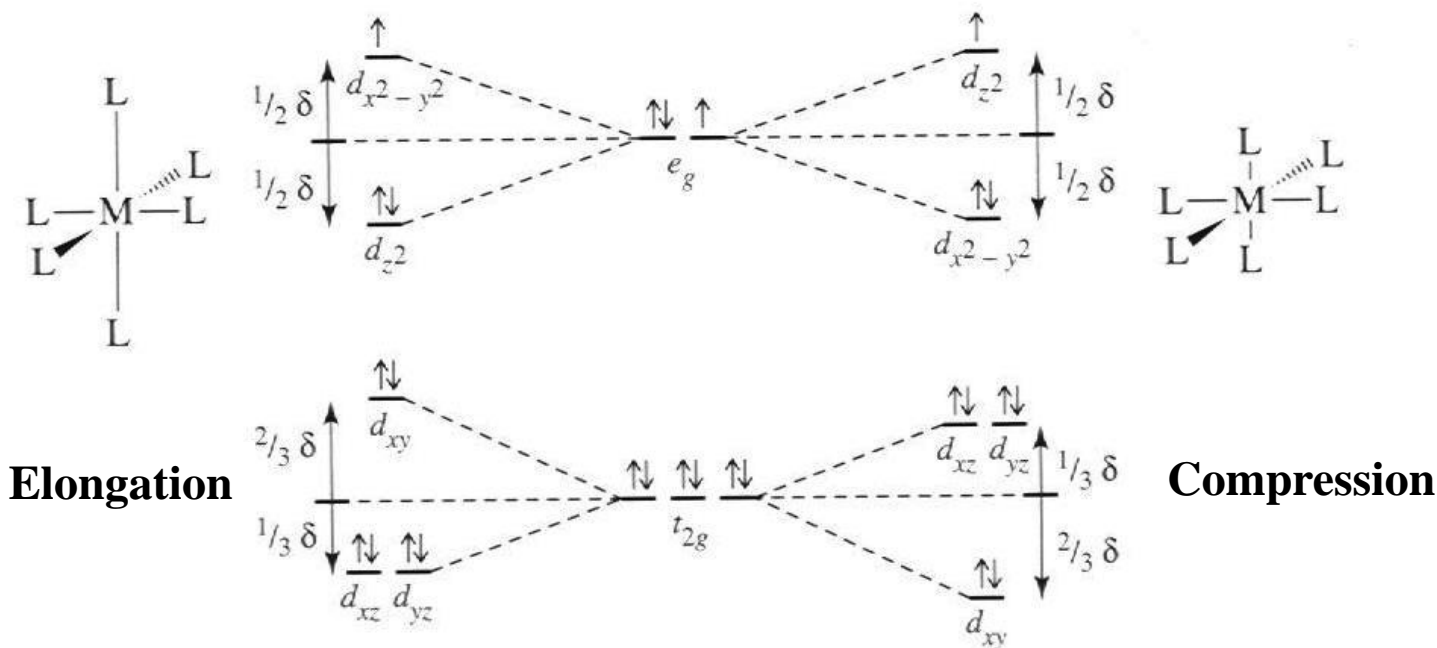

Electronic-configuration	nd^1	nd^2	nd^3	nd^4	nd^5	nd^6	nd^7	nd^8	nd^9	nd^{10}
High-spin J.T.	Weak	Weak	-	Strong	-	weak	Weak	-	Strong	-
Low-spin J.T.	Weak	Weak	-	Weak	Weak	-	Strong	-	Strong	-

7. Principals in Coordination Chemistry

Static vs. Dynamic Jahn-Teller-Effect in Octahedral Field

Static Jahn-Teller-Effect

Prerequisite: Electronic degeneracy in e_g^* -level

Detection: RSA, IR, UV/Vis

Example: $K_2Na[MnF_6]$ Mn^{III} : $[Ar]3d^4$ h.s. elongated octahedron
 $[Cu(NH_3)_6]^{2+}$ Cu^{II} : $[Ar]3d^9$ elongated octahedron

Dynamic Jahn-Teller-Effect

Prerequisite: Electronic degeneracy in t_{2g} -level

Detection: Difficult at room temperature, since δ is in the range of $k_B T$ ($\sim 200 \text{ cm}^{-1}$)

Example: $K_2Na[TiF_6]$ Ti^{III} : $[Ar]3d^1$ regular octahedron
crystallises at room temperature in cubic structure
 \Rightarrow Jahn-Teller polarons in $BaTiO_3$!

7. Principals in Coordination Chemistry

Crystal Field Splitting in Tetrahedral Field

Tetrahedral Crystal Field

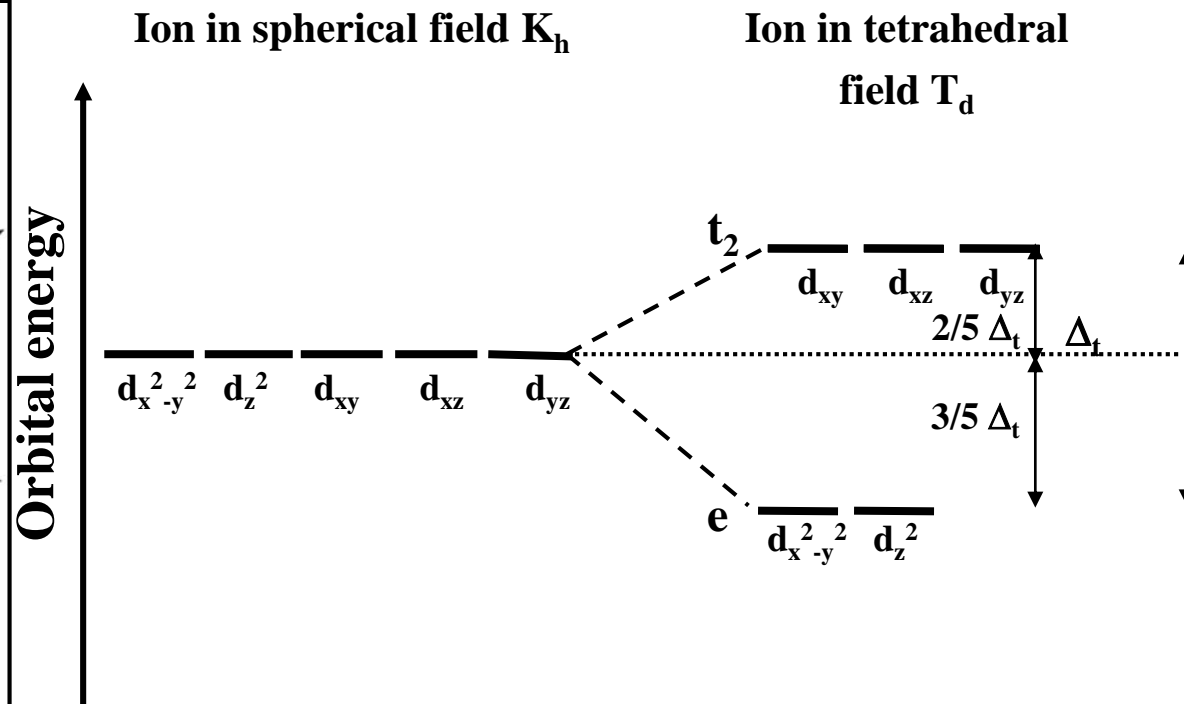
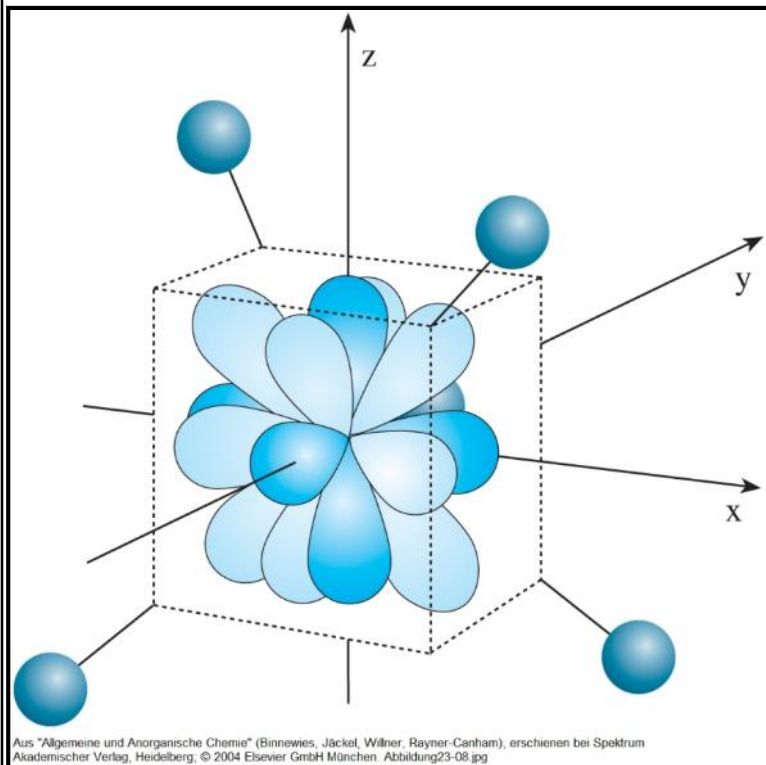

The energy gap between the t_2 and the e -orbitals Δ_t is only $4/9$ of Δ_o , because only four instead of six ligands are present and those are not situated on the axes of the d-orbitals.

7. Principals in Coordination Chemistry

CFSE in Octahedral and Tetrahedral Field

Crystal field stabilisation energy in tetrahedral vs. octahedral crystal field

Calculation with $\Delta_t = 4/9\Delta_o$

“site preference”

d^n	CFSE(tetrahedral)	CFSE(octahedral)	Δ CFSE(octahedr. – tetrahedr.)
1	-2.67 Dq_o	-4 Dq_o	-1.33 Dq_o
2	-5.33 Dq_o	-8 Dq_o	-2.67 Dq_o
3	-3.55 Dq_o	-12 Dq_o	-8.45 Dq_o
4	-1.78 Dq_o	-6 Dq_o (h.s.) -16 Dq_o + 1 P (l.s.)	-4.22 Dq_o -14.22 Dq_o + 1 P
5	0 Dq_o	0 Dq_o (h.s.) -20 Dq_o + 2 P (l.s.)	0 Dq_o -20 Dq_o + 2 P
6	-2.67 Dq_o	-4 Dq_o (h.s.) -24 Dq_o + 2 P (l.s.)	-1.33 Dq_o -21.33 Dq_o + 2 P
7	-5.33 Dq_o	-8 Dq_o (h.s.) -18 Dq_o + 1 P (l.s.)	-2.67 Dq_o -12.67 Dq_o + 1 P
8	-3.55 Dq_o	-12 Dq_o	-8.45 Dq_o
9	-1.78 Dq_o	-6 Dq_o	-4.22 Dq_o
10	0 Dq_o	0 Dq_o	0 Dq_o

7. Principals in Coordination Chemistry

CFSE in Tetrahedral Field

Some general rules

The magnitude of the CFSE in the tetrahedral field is only 4/9 of that in the octahedral field!

- Only high-spin complexes
- Ions with electronic configurations, leading to high CFSE, e.g. with $[\text{Ar}]3d^3$ -, $[\text{Ar}]3d^5(\text{low-spin})$ - or $[\text{Ar}]3d^6(\text{low-spin})$ -configuration, favour, if possible, octahedral coordination polyhedra
⇒ aqua complexes

Tetrahedral coordination polyhedra are observed for:

- Bulky ligands, i.e. proteins
- Ligands with double or triple bonds to the metal centre, e.g. oxy- and nitride ligands

Rule: There is no electron configuration where the electronic stabilisation is higher for the tetrahedral than for the octahedral coordination (site preference) ⇒ Octahedral geometry is preferred

Exception: d^5 (high-spin) and d^{10} , because CFSE in both octahedron and tetrahedron are zero

7. Principals in Coordination Chemistry

Crystal Field Splitting in Different Symmetries

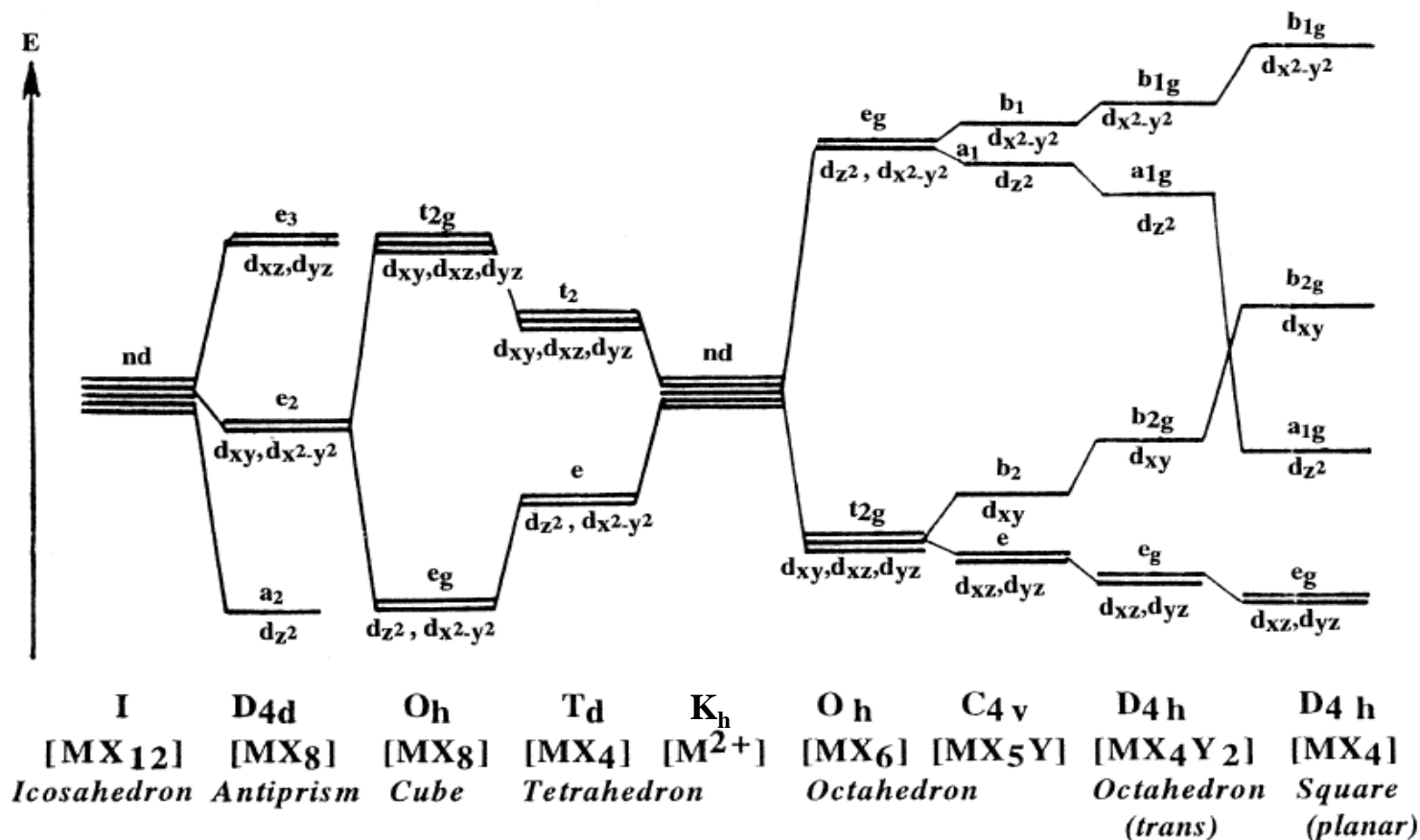
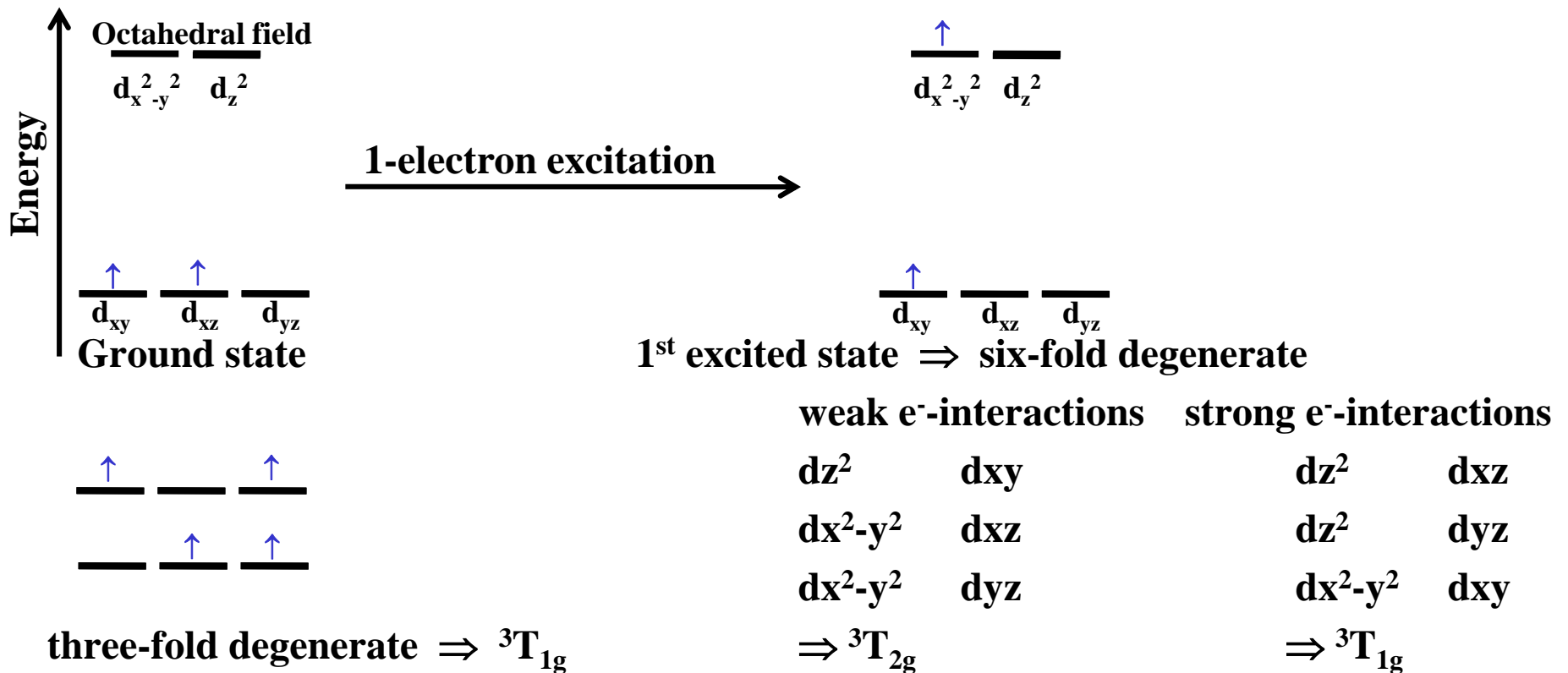

FIGURE 4.5. Splitting of d orbital energy levels in ligand fields of different symmetries. In MX_5Y and MX_4Y_2 complexes the splitting of the T_{2g} and E_g terms can be inverted depending on the ratio of field strengths X/Y . (After Schmidtke [4.12].)

7. Principals in Coordination Chemistry

Description of Electronic States in Multiple-Electron-Atoms

Method of the strong field: LS-coupling is considerably smaller than crystal field splitting \Rightarrow true for elements of the 3d-series up to bromine



7. Principals in Coordination Chemistry

Description of Electronic States in Multiple-Electron-Atoms

Method of the strong field: LS-coupling is considerably smaller than crystal field splitting \Rightarrow true for elements of the 3d-series up to bromine

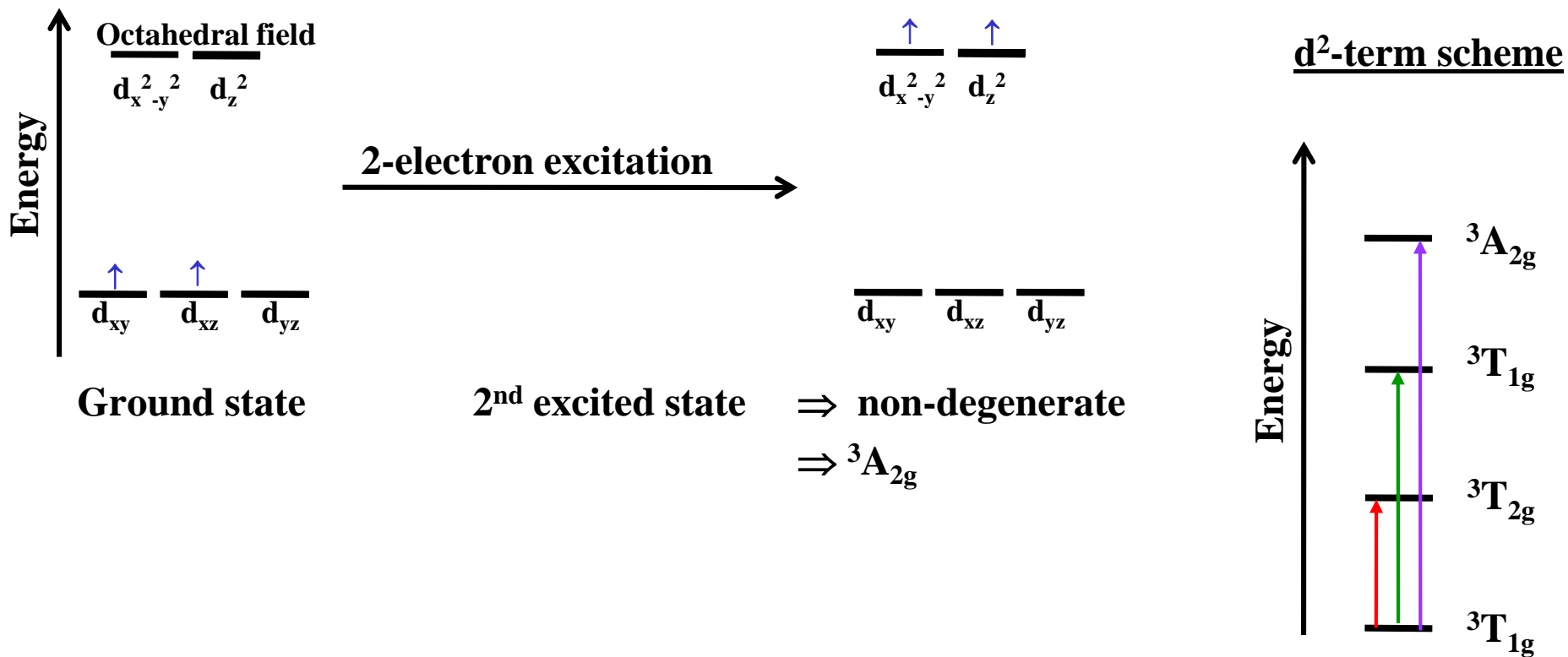

7. Principals in Coordination Chemistry

Description of Electronic States in Multiple-Electron-Atoms

Method of the weak field: LS-coupling is notably stronger than the crystal field splitting \Rightarrow true from bromine on, thus for the elements of the 4d- and 5d-series as well as the lanthanides (\rightarrow Dieke-diagram) and the actinides

Electron configuration



ml -2 -1 0 1 2

orbital and spin momentum L and S

$$L = |\Sigma l_i| \text{ and } S = \Sigma s_i$$

Coulomb-interactions

Spin-orbit coupling

Crystal field splitting

Crystal field energy terms

\Rightarrow A, B, E, T

Total angular momentum J

$$J = |L - S| \dots |L + S|$$

7. Principals in Coordination Chemistry

Description of Electronic States in Multiple-Electron-Atoms

Orbital angular momentum $L = |\Sigma l_i|$

$ M_l $	0	1	2	3	4	5	6	7	8	9	...
	S	P	D	F	G	H	I	K	L	M	...

Spin angular momentum $S = \Sigma s_i$

$ M_s $	0	$1/2$	1	$3/2$	2	$5/2$...
$2S+1$	1	2	3	4	5	6	...
	Singlet	Doublet	Triplet	Quartet	Quintet	Sextet	...

$$2S+1L$$

Total angular momentum $J = |L - S| \dots |L + S|$
 results from different orientations
 of L and S towards each other
 \Rightarrow Russell-Saunders (RS) coupling

$$2S+1L_J$$

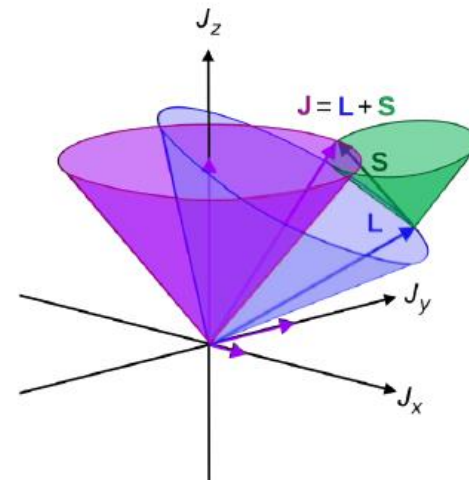

http://upload.wikimedia.org/wikipedia/commons/thumb/3/30/LS_coupling.svg/2000px-LS_coupling.svg.png

7. Principals in Coordination Chemistry

Quantum Mechanical Micro States

$$\text{Number \#} = \frac{n!}{e!h!}$$

with n = maximal number of electrons in sub-shell
(sum of $e + h$)

e = number of electrons of corresponding
configuration

h = number of holes of corresponding
configuration

p-shell $\Rightarrow n = 6$ e

	1	2	3	4	5	6
#	6	15	20	15	6	1

Discussion of three electron configurations

1. Elemental carbon [He]2s²2p²
2. 3d-transition metal ions [Ar]3dⁿ
3. Lanthanide ions Ln³⁺ [Xe]4fⁿ

7. Principals in Coordination Chemistry

Examples for Micro States: p^2 -Configuration, i.e. 2 Electrons in p-Orbitals

L	+2	0	-2	+1	0	-1	+1	0	-1
+1	↑↓			↑	↑		↓	↓	
0		↑↓		↑		↑	↓		↓
-1			↑↓		↑	↑		↓	↓
S	0	0	0	+1	+1	+1	-1	-1	-1
L	+1	0	-1	+1	0	-1			
+1	↑	↑		↓	↓				
0	↓		↑	↑		↓			
-1		↓	↓		↑	↑			
S	0	0	0	0	0	0			

⇒ 15 micro states

7. Principals in Coordination Chemistry

RS-Terms for the $2p^2$ -Configuration

$$L = 2 \quad M_L = -2, -1, 0, 1, 2$$

$$S = 1 \quad M_S = -1, 0, 1$$

$$M_L = 2 \text{ and } M_S = 0 \Rightarrow {}^1D$$

$L =$	$+2$	$+1$	0	-1	-2
$S = 0$	X	X	X	X	X

$$M_L = 1 \text{ and } M_S = 1 \Rightarrow {}^3P$$

$L =$	$+1$	0	-1
$S = +1$	X	X	X
$S = 0$	X	X	X
$S = -1$	X	X	X

$$M_L = 0 \text{ and } M_S = 0 \Rightarrow {}^1S$$

$L =$	0
$S = 0$	X

Hund's rules (3 different ones)

\Rightarrow Energetic order for $2p^2$ config.:

1st S as high as possible
 2nd L as high as possible
 ${}^3P < {}^1D < {}^1S$

3rd Hund's rule for J:
 $J = |L - S|$ most stable for
 shells filled less than half

7. Principals in Coordination Chemistry

RS-Terms for the d^n -Configurations

d^n	-2	-1	0	1	2	L	S	$2S+1L_J$	Ground term h.s. (l. s.)
d^1	↑					2	1/2		2D
d^2	↑	↑				3	1		3F
d^3	↑	↑	↑			3	3/2		4F
d^4	↑	↑	↑	↑		2	2		5D (3H)
d^5	↑	↑	↑	↑	↑	0	5/2		6S (2I)
d^6	↑↓	↑	↑	↑	↑	2	2		5D (1I)
d^7	↑↓	↑↓	↑	↑	↑	3	3/2		4F (2H)
d^8	↑↓	↑↓	↑↓	↑	↑	3	1		3F
d^9	↑↓	↑↓	↑↓	↑↓	↑	2	1/2		2D

7. Principals in Coordination Chemistry

RS-Terms for all d^n -Configurations

All Russell Saunders terms for $3d^n$ free ion configurations

Configuration	# Micro-states	# Energy levels	Ground state terms	Excited energy terms
d^1, d^9	10	1	2D	-
d^2, d^8	45	5	3F	$^3P, ^1G, ^1D, ^1S$
d^3, d^7	120	8	4F	$^4P, ^2H, ^2G, ^2F, 2x ^2D, ^2P$
d^4, d^6	210	16	5D	$^3H, ^3G, 2x ^3F, ^3D, 2x ^3P, ^1I, 2x ^1G, ^1F, 2x ^1D, 2x ^1S$
d^5	252	16	6S	$^4G, ^4F, ^4D, ^4P, ^2I, ^2H, 2x ^2G, 2x ^2F, 3x ^2D, ^2P, ^2S$
d^{10}	1	1	1S	-

7. Principals in Coordination Chemistry

Splitting of RS-Terms in Crystal Field \Rightarrow Splitting Terms

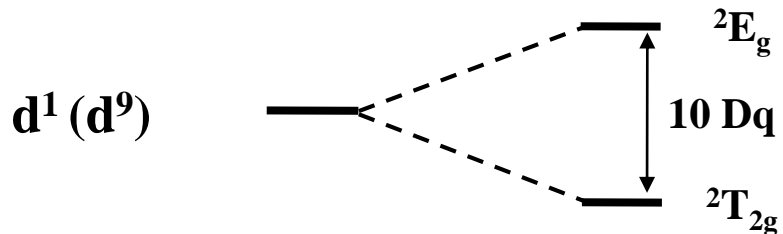

1 band

$$\Delta E = 10 Dq$$

Inverse splitting in tetrahedral field

V^{4+}

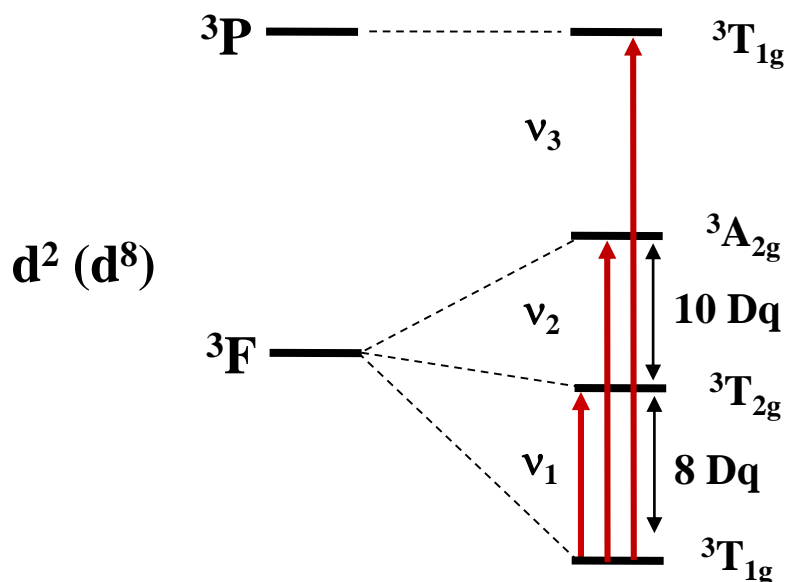
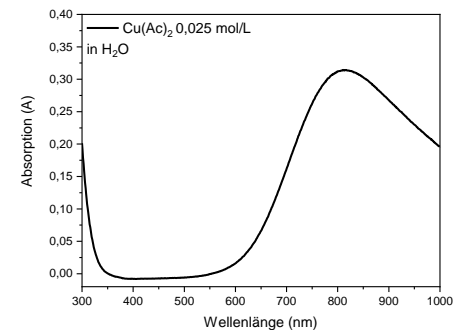

3 bands

\Rightarrow determination of $10 Dq$ possible only by subtraction = $\nu_2 - \nu_1$

V^{3+}, Mn^{5+}

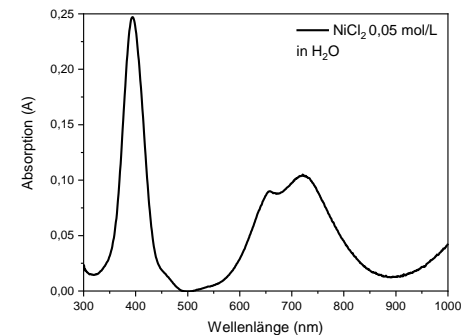

7. Principals in Coordination Chemistry

Splitting of RS-Terms in Crystal Field \Rightarrow Splitting Terms

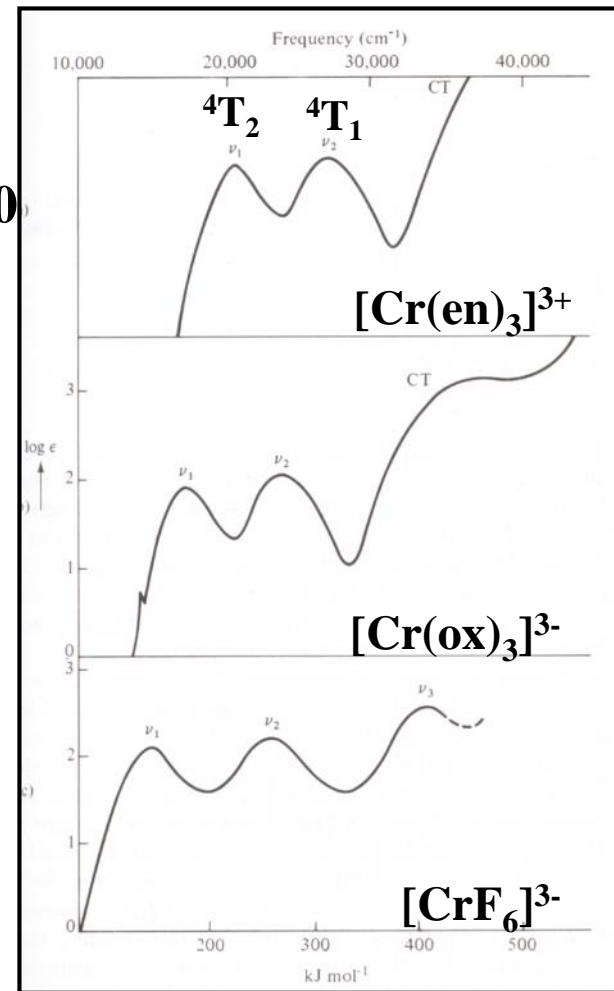
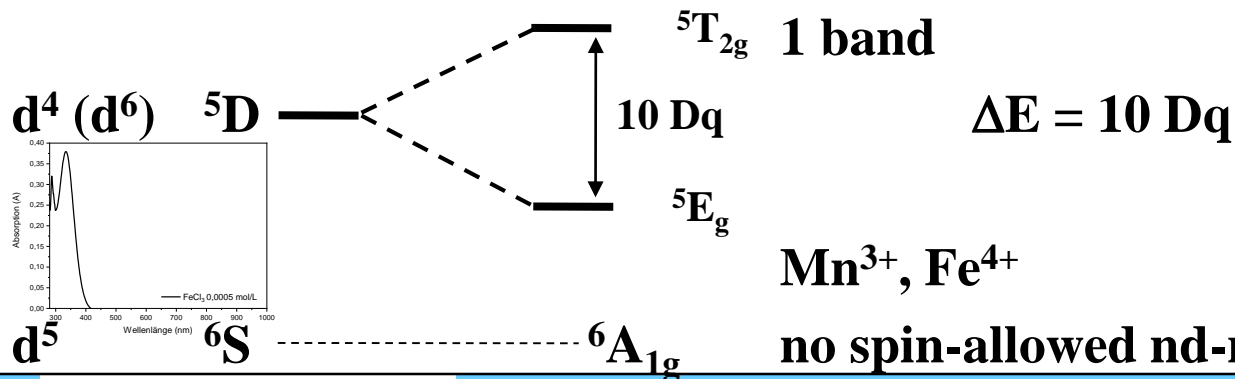
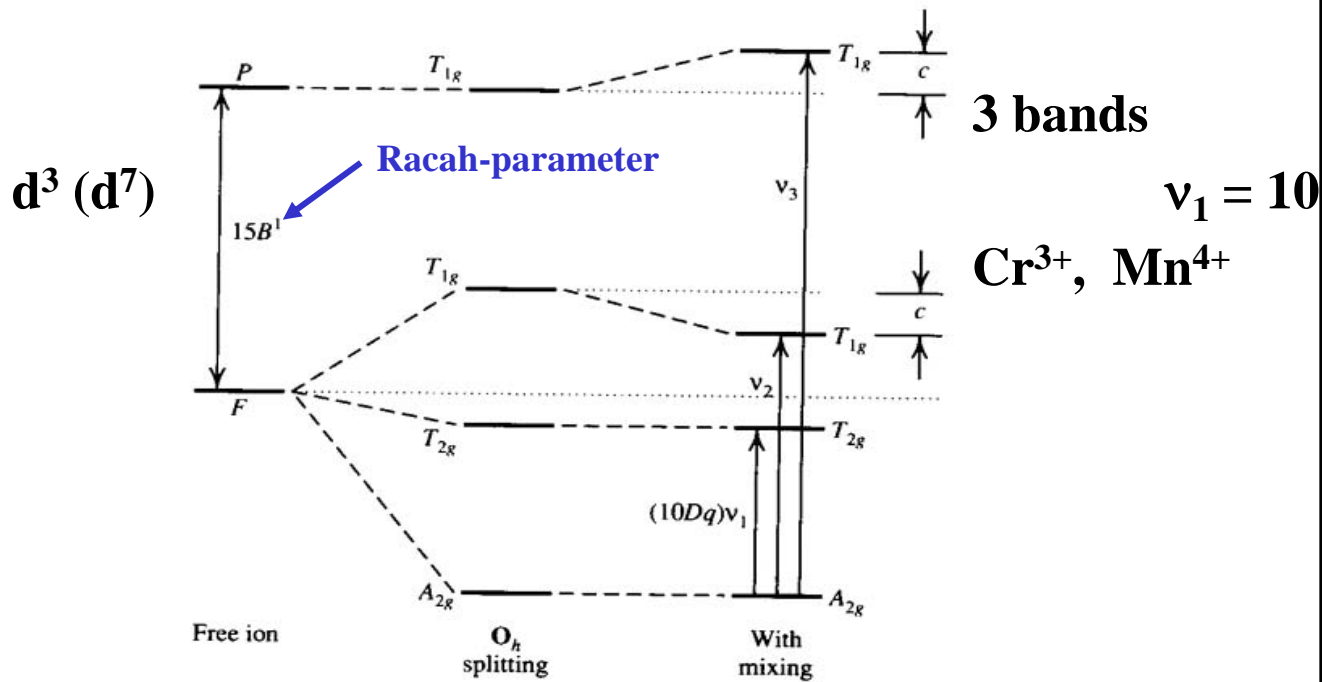

7. Principals in Coordination Chemistry

Splitting of RS-Terms in Crystal Field \Rightarrow Calculation of $10 Dq$

Octahedron d^1, d^4, d^6 and d^9
1 band $10 Dq = \nu$

Octahedron d^2
3 bands $10 Dq = \nu_2 - \nu_1$ and **B** by calculation

Octahedron d^7
3 bands $10 Dq = \nu_2 - \nu_1$ and **B** by calculation

Octahedron d^3 and d^8
3 bands $10 Dq = \nu_1$ and **B** by calculation

$$\frac{B}{Dq} = \frac{(\frac{\Delta E}{Dq})^2 - 10 \frac{\Delta E}{Dq}}{15(\frac{\Delta E}{Dq} - 8)}$$
$$Dq = E(^4T_2) / 10$$
$$\Delta E = E(^4T_1) - E(^4T_2)$$

7. Principals in Coordination Chemistry

Interelectronic Repulsion: Racah-Parameter A, B, and C (Giulio Racah 1909 - 1965)

Means to describe the Interelectronic repulsion or Coulomb-repulsion between the terms, with B being the most important Racah-parameter, because it directly describes the splitting between the RS-terms.

Free M^{n+} -ion

$B \sim 500 - 1100 \text{ cm}^{-1}$

$C \sim 4 B$ (approximation!)

$$A = F_0 - 49 F_4$$

$$B = F_2 - 5 F_4$$

$$C = 35 F_4$$

(with $F_{0,2,4}$ = Slater-integrals)

Complexed M^{n+} -ion

B is ca. 30% smaller due to the nephelauxetic effect, i.e. the delocalisation of metal-centred electrons to the ligands $\Rightarrow B'$

Nephelauxetic ratio

$$\beta = B'/B$$

$$\text{with } (1-\beta) = h_L * k_M$$

h_L = nephelauxetic parameter of ligands

k_M = nephelauxetic parameter of the metals

7. Principals in Coordination Chemistry

Nephelauxetic Effect ~ Electron Density Between Metal Ions and Ligands

- Quantification of effect by parameter $\beta = B'/B$
- Ionic charge density and polarizability of the ligands by parameter h_L

<u>Ligand</u>	<u>h_L</u>
F ⁻	0.8
H ₂ O	1.0
DMF	1.2
(NH ₂) ₂ CO	1.2
NH ₃	1.4
en	1.5
C ₂ O ₄ ²⁻	1.5
Cl ⁻	2.0
CN ⁻	2.1
Br ⁻	2.3
N ₃ ⁻	2.4
I ⁻	2.7

7. Principals in Coordination Chemistry

Energies of Splitting Terms as Function of the Field Strength \Rightarrow Orgel-Diagram

Low-spin configurations
are not taken into account
(weak crystal field!)

Only terms with same spin
multiplicity as the ground state
are considered

“1 electron configuration”
 d^1 and d^6

“1 hole configuration”
 d^4 and d^9

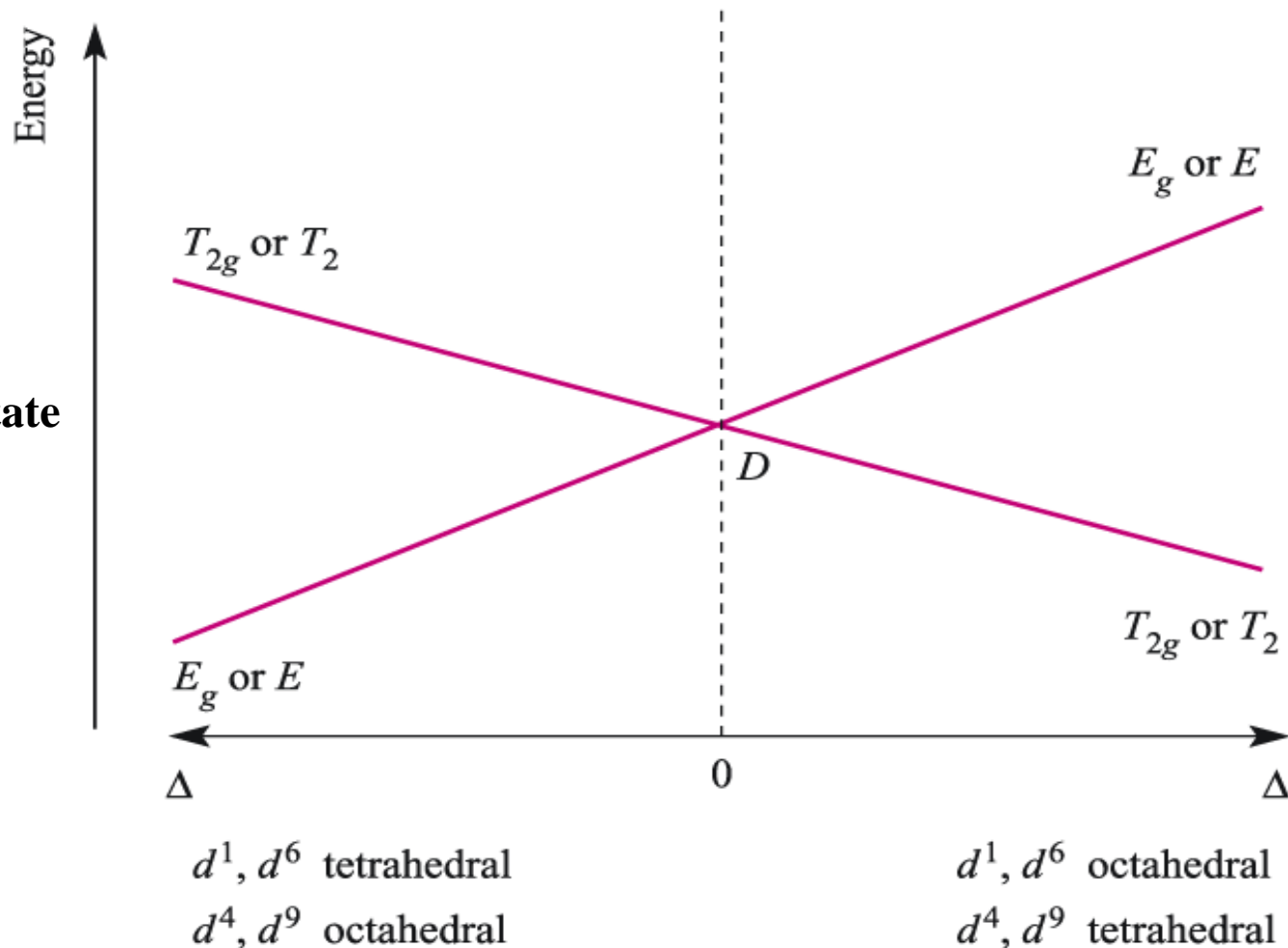

7. Principals in Coordination Chemistry

Energies of Splitting Terms as Function of the Field Strength \Rightarrow Orgel-Diagram

Low-spin configurations
are not taken into account
(weak crystal field!)

Only terms with same spin
multiplicity as the ground state
are considered

“2 electron configuration”
 d^2 and d^7

“2 hole configuration”
 d^3 and d^8

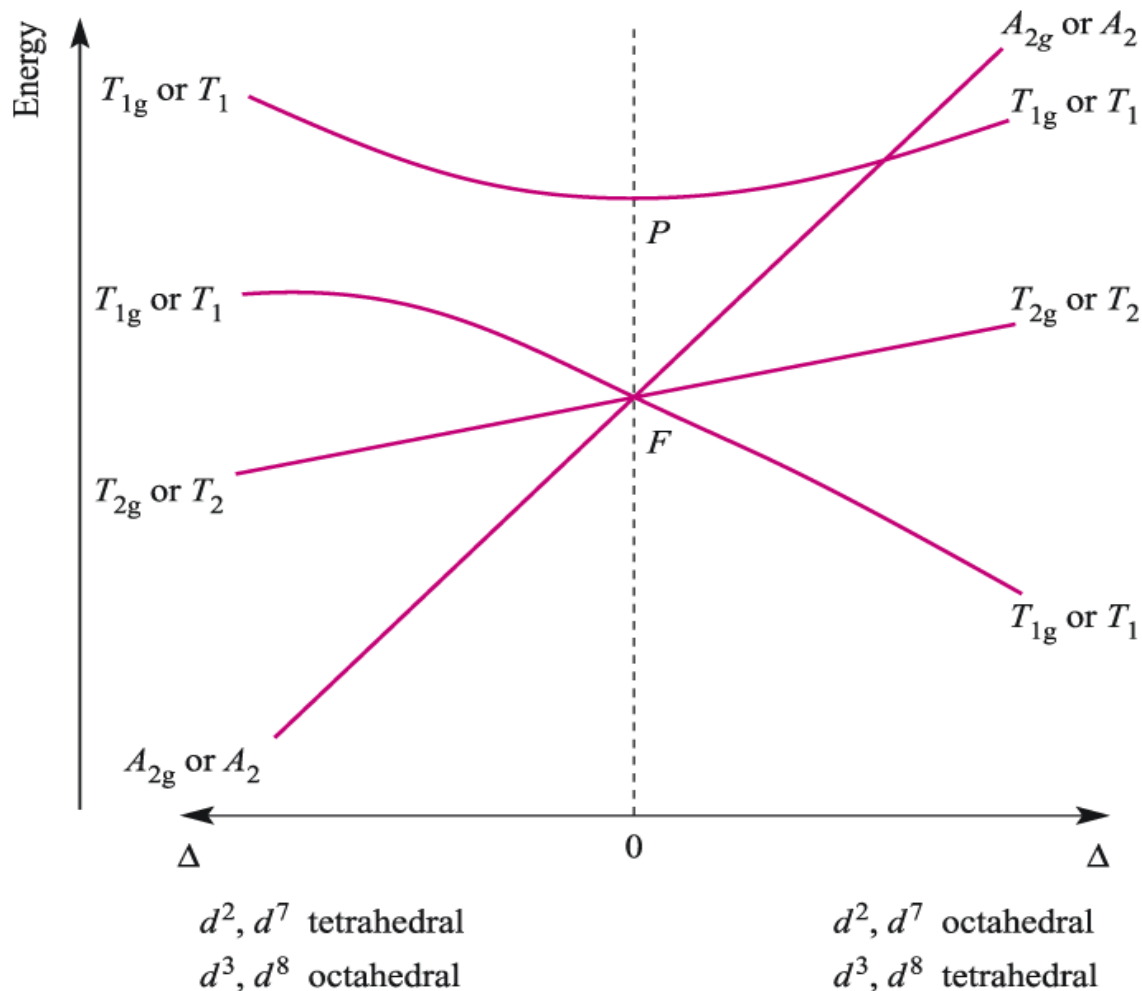

7. Principals in Coordination Chemistry

Tanabe-Sugano-Diagram (Term Correlations)

- Also low-spin terms and other spin multiplicities are taken into account
- The abscissa equals the energy of the ground term
- The energy of the crystal field terms is normalised by B
- The magnitude of B depends on the ion

Configuration	Ion	B [cm ⁻¹]	C [cm ⁻¹]
3d ³	Cr ³⁺	918	3850
	Mn ⁴⁺	1064	
3d ⁴	Cr ²⁺	830	3430
	Mn ³⁺	1140	3675
3d ⁵	Mn ²⁺	960	3325
3d ⁶	Fe ²⁺	1058	3901
	Co ³⁺	1100	

*d*³ Tanabe-Sugano Diagram

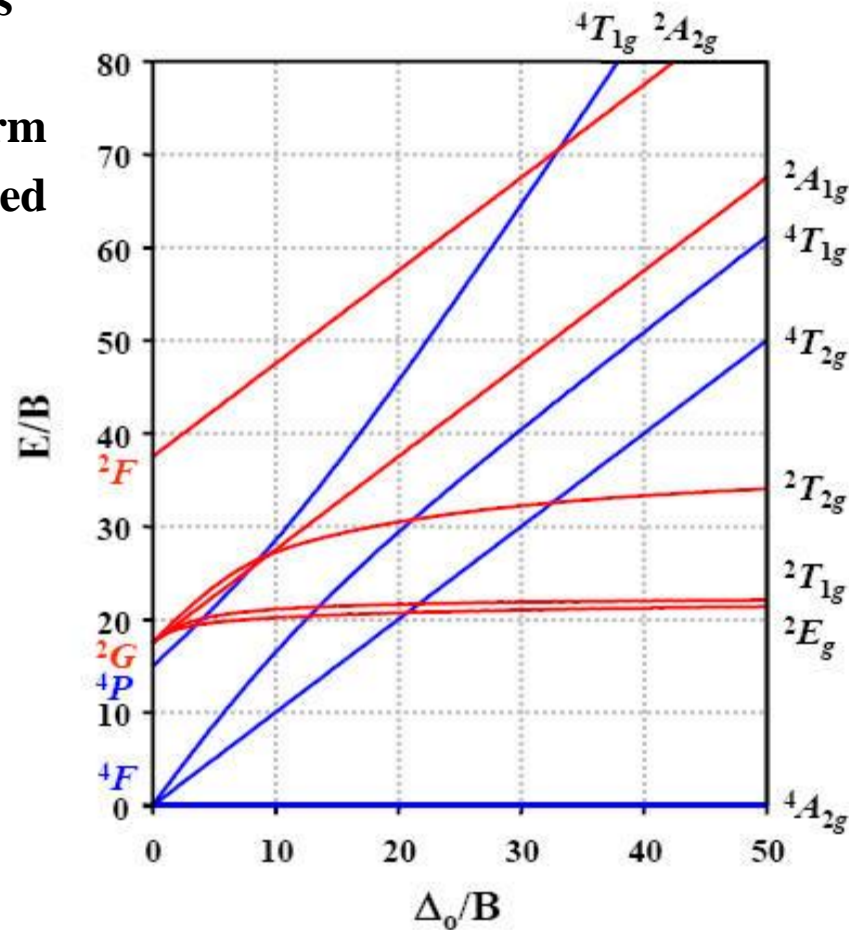

7. Principals in Coordination Chemistry

Optical Spectra of 3d-Ions

Energetic positions of terms

- Coulomb-interaction $\sim 10000 \text{ cm}^{-1}$
- Spin-orbit-coupling $\sim 100 \text{ cm}^{-1}$
- Crystal field splitting $\sim 1000 \text{ cm}^{-1}$

Shape of optical transitions

- Parallel terms:
Sharp lines
- Terms with different slopes:
Broad bands

Selection rules

- All $d^n \rightarrow d^n$ transitions are parity-forbidden ($g \leftrightarrow g$)
- Transitions between different spins are also spin-forbidden
- Specific symmetric selection rules according to group theory (Ref.: F.A. Cotton, "Chemical Applications of Group Theory")

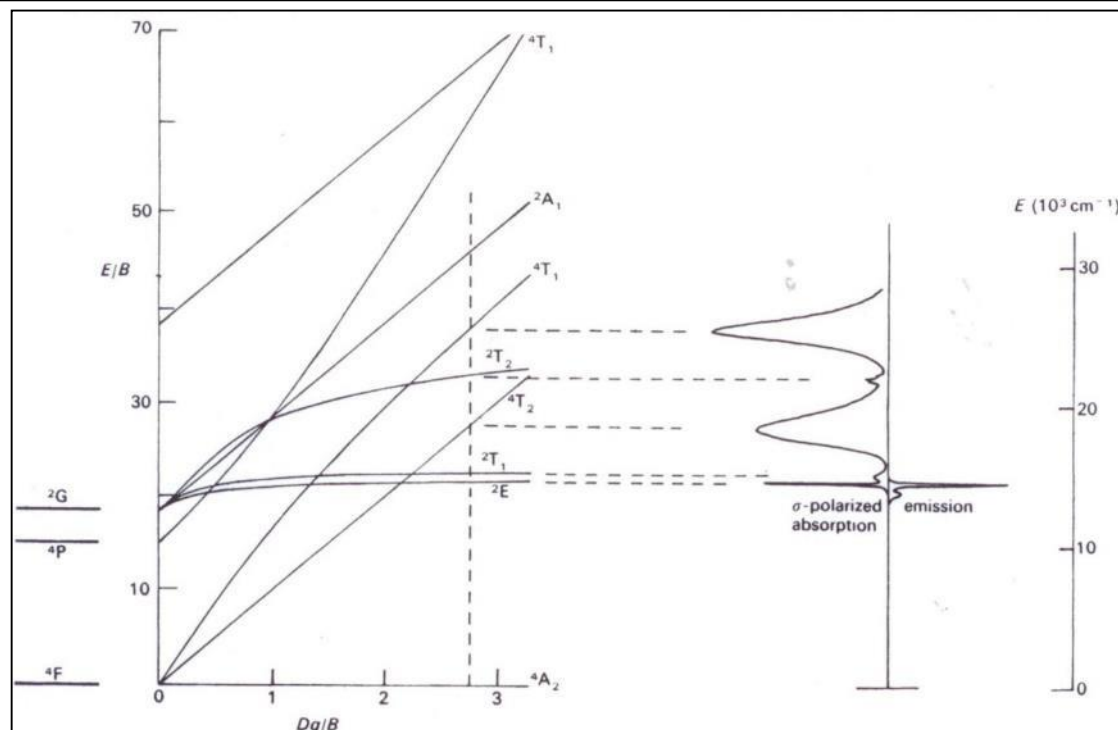

7. Principals in Coordination Chemistry

Ln³⁺-Ions

Pr³⁺ ground state

[Xe]4f² → 13 SLJ-levels (91 microstates)

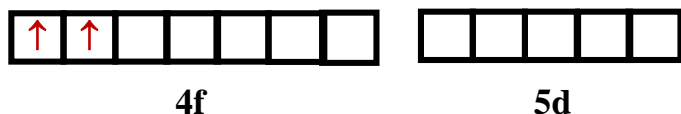

Pr³⁺ 1st excited state

[Xe]4f¹5d¹ → 2 SLJ-levels



⇒ [Xe]4f² – [Xe]4f² transitions

⇒ [Xe]4f² – [Xe]4f¹5d¹ transitions

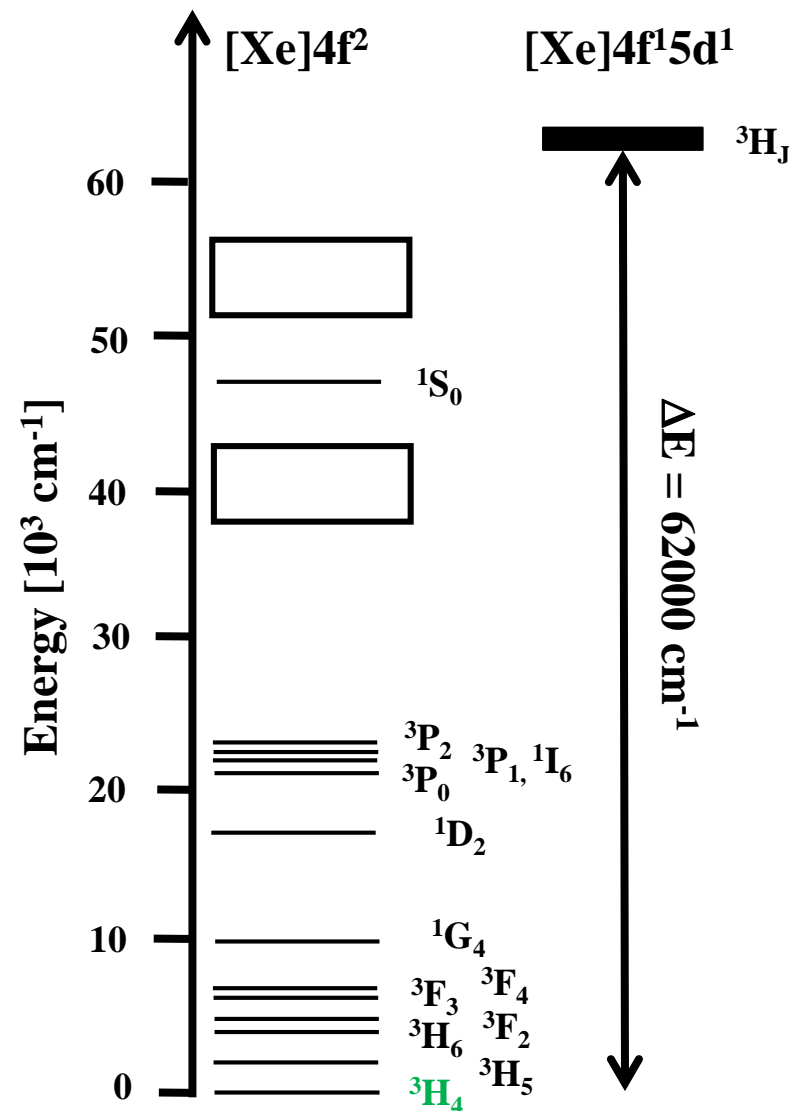

7. Principals in Coordination Chemistry

Pr³⁺-Ion with 4f²-Configuration → 91 Microstates

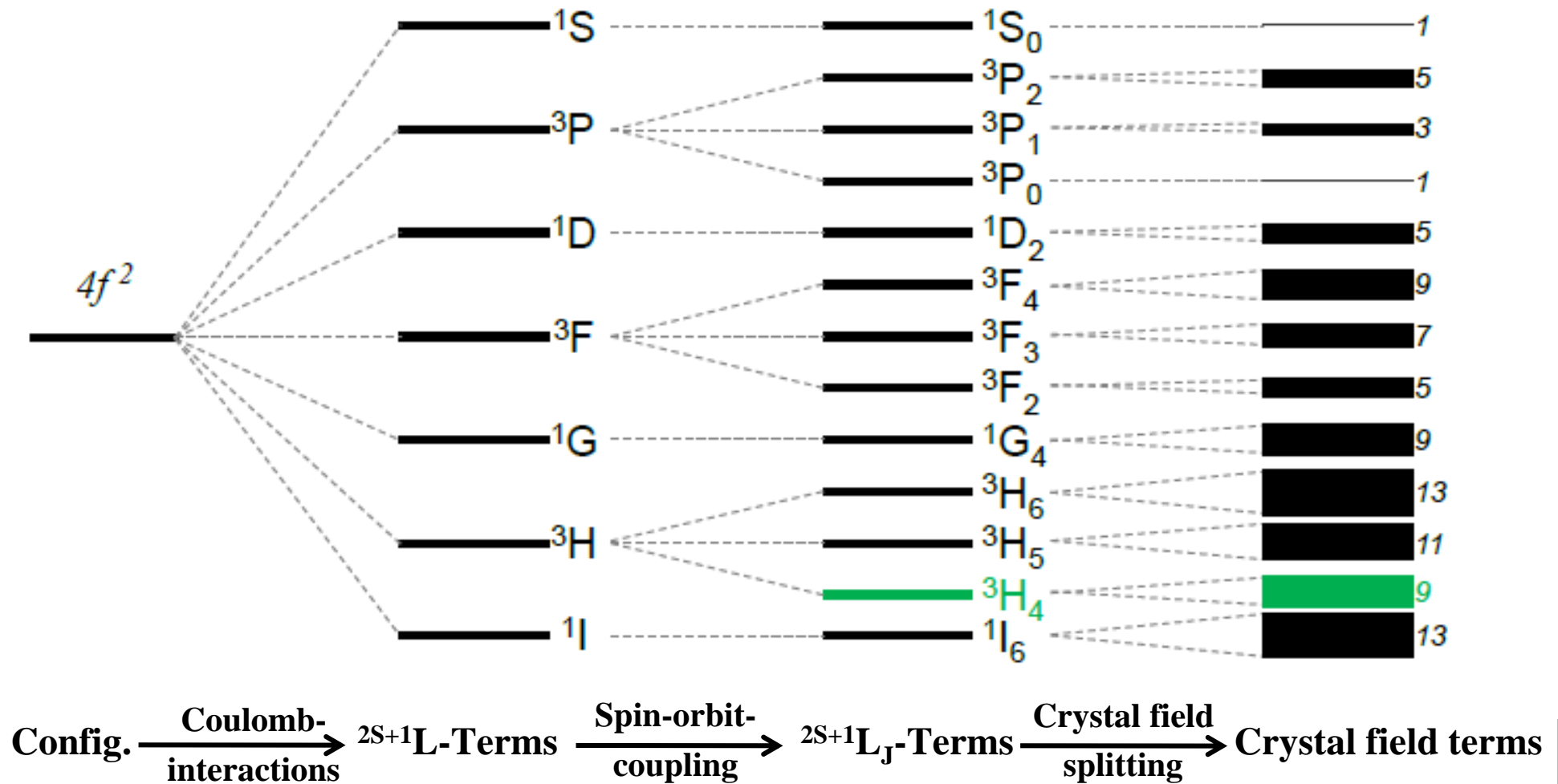

Energetic ordering is subject to the three Hund rules

7. Principals in Coordination Chemistry

Ln³⁺-Ions with 4fⁿ-Configuration: Pr³⁺ with [Xe]4f² ground state configuration

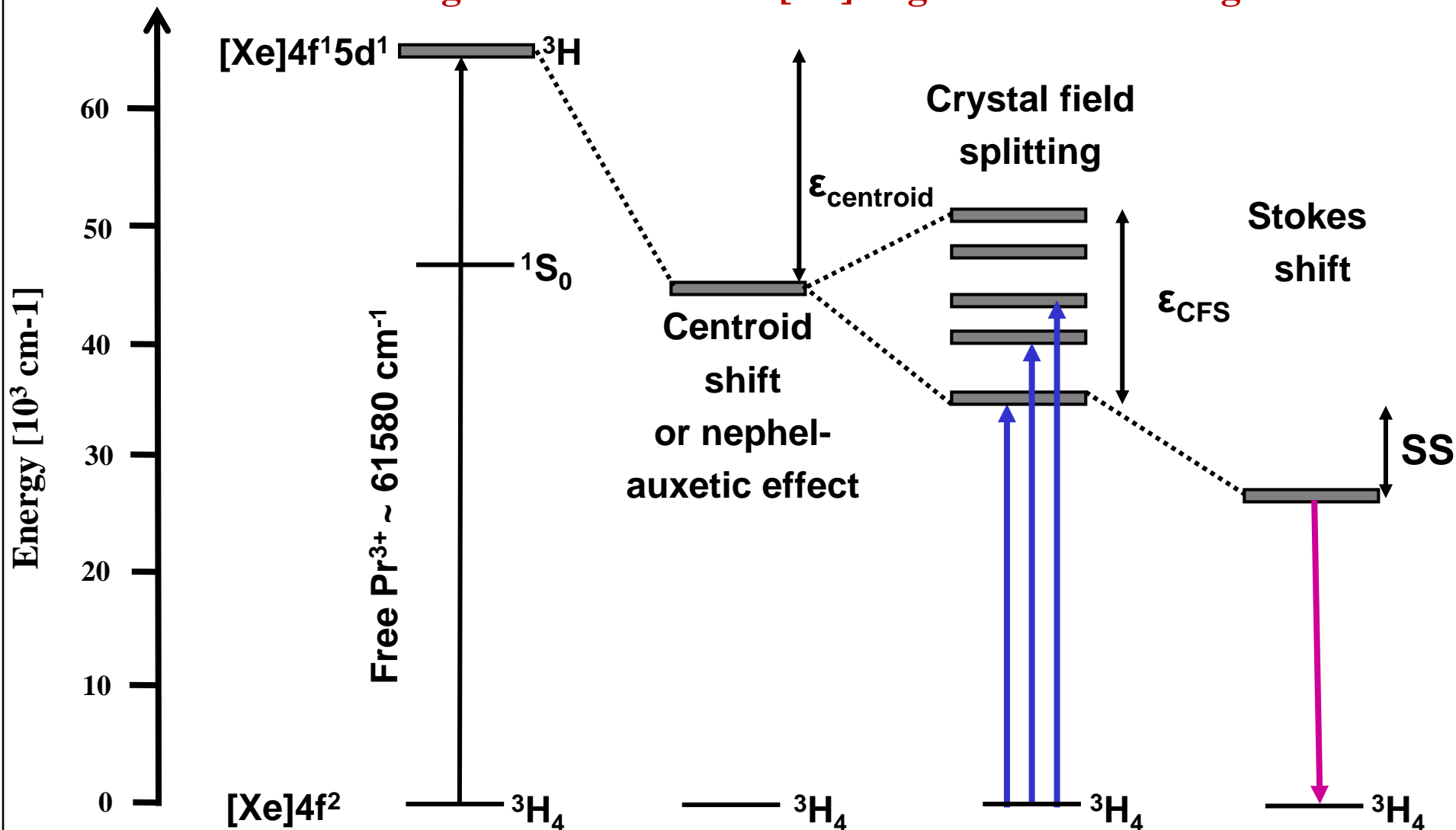

7. Principals in Coordination Chemistry

Ln³⁺-Ions with 4fⁿ-Configuration: Pr³⁺ with [Xe]4f² ground state configuration

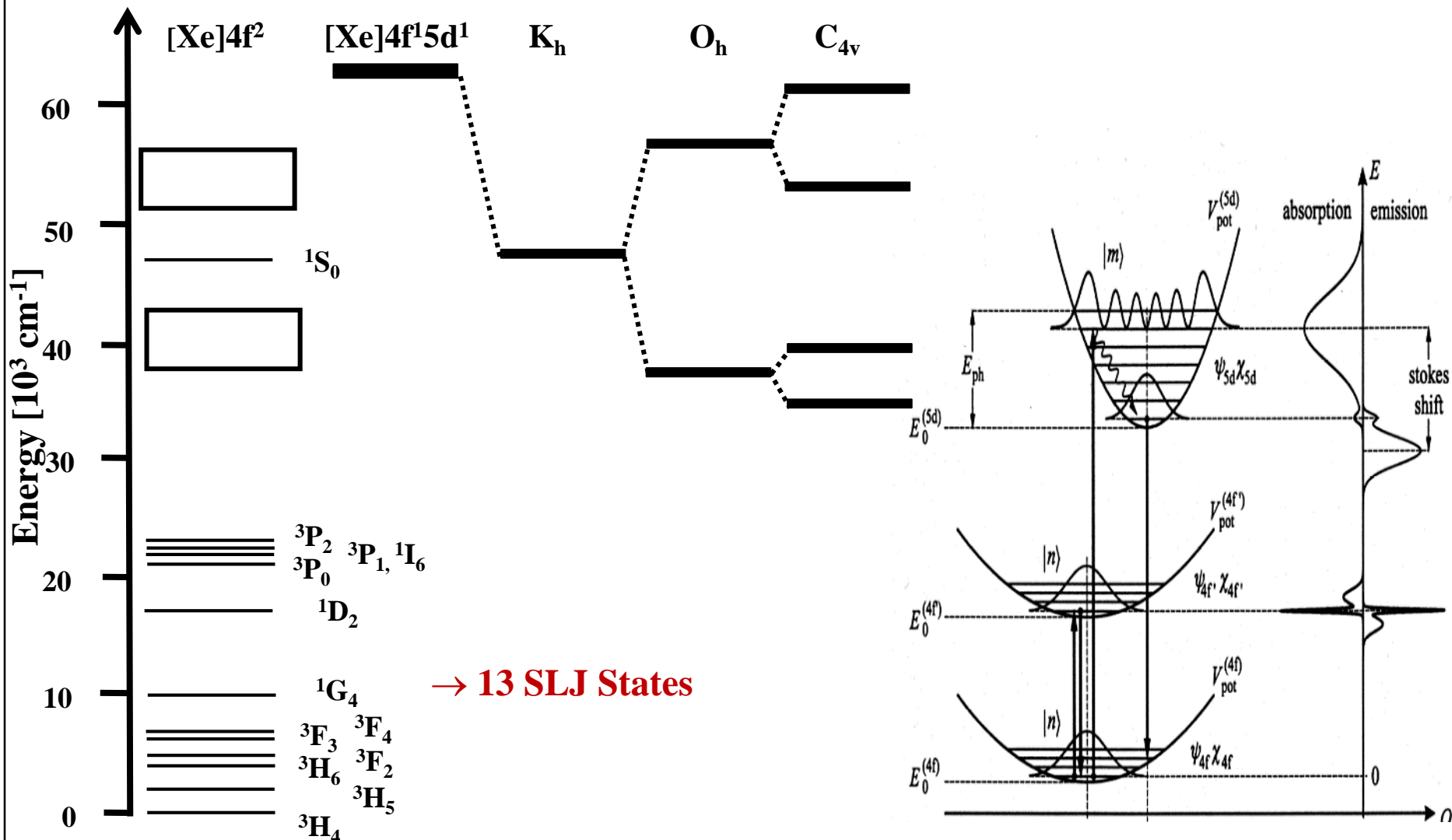

→ 13 SLJ States

7. Principals in Coordination Chemistry

Ln³⁺-Ions with 4fⁿ-Configuration: Pr³⁺ with [Xe]4f² ground state configuration

- Haber-Bosch process (α -Fe) $\text{N}_2 + 3 \text{H}_2 \rightleftharpoons 2 \text{NH}_3$ (400 -500 °C)
- Mo/Fe Nitrogenase (Fe^{n+}) $2 \text{N}_2 + 10 \text{H}^+ + 8 \text{e}^- \rightleftharpoons 2 \text{NH}_4^+ + \text{H}_2$ (RT)
- Heterogeneous photocatalysis by up-conversion induced photoionisation
Semiconductor (SC) + blue laser \rightarrow SC* \rightarrow SC** [e^- (CB) + h^+ (VB)]
 e^- (CB) + $\text{N}_2 \rightarrow (\text{N}_2)^-$
 $6 (\text{N}_2)^- + 6 \text{H}_2\text{O} \rightarrow 6 \text{OH}^- + 5 \text{N}_2 + 2 \text{NH}_3$

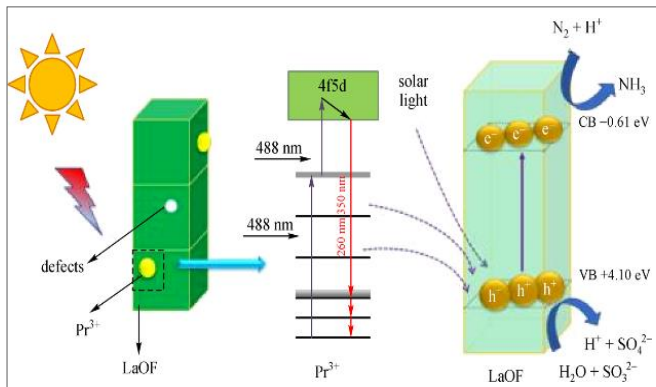

Photocatalytical NH₃ formation at LaOF:Pr

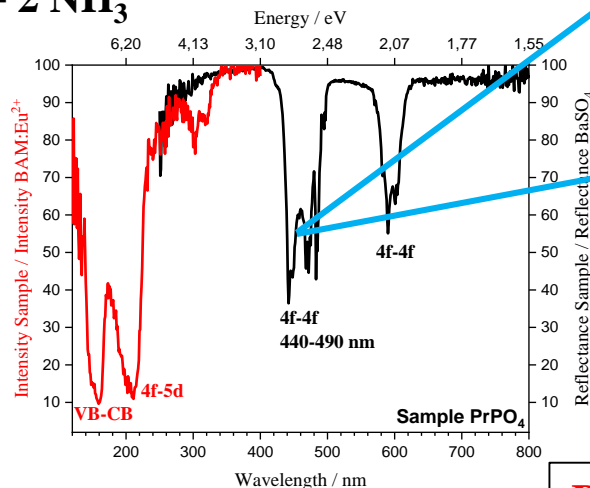

Reflection spectrum of PrPO₄

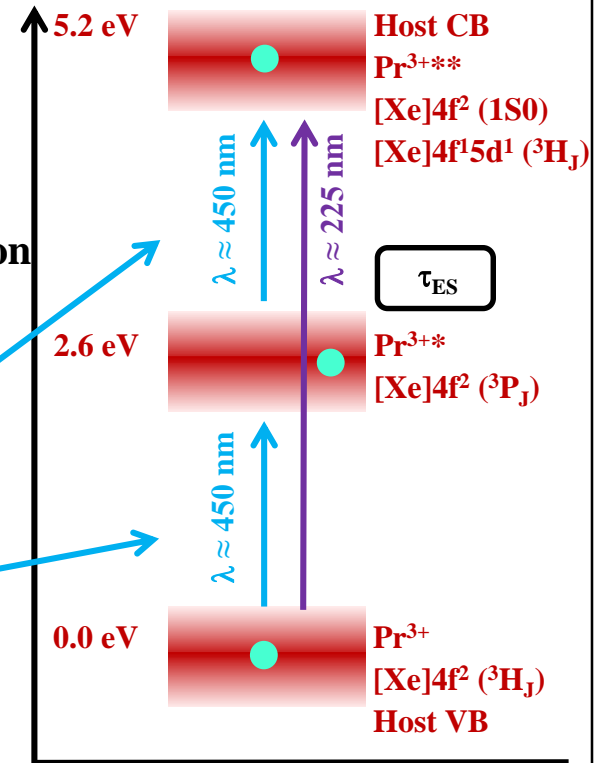

Simplified energy level scheme of Pr³⁺

**Bioinorganic chemistry driven idea:
Can Pr³⁺ serve for the N₂ fixation?**

Lit.: LaOF-Pr MW hydrothermal synthesis for photocatalytic N fixation, Front Mater Science 14 (2020) 43

7. Principals in Coordination Chemistry

Crystal Field and Ligand Field

Back-binding to ligands

- Typical for CO, NO, O₂, CN⁻, some biochemically important molecules!
- Formally, metals have low oxidation state or high electron density, respectively which is spread over the ligands through back-transfer of charge

Example: M(CO)₆ “metal carbonyl“



a) σ -donor-bond

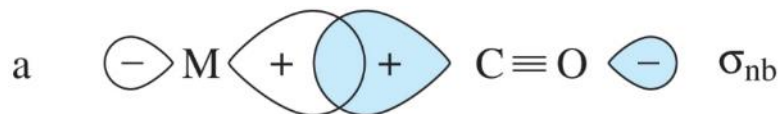

b) π -acceptor-bond

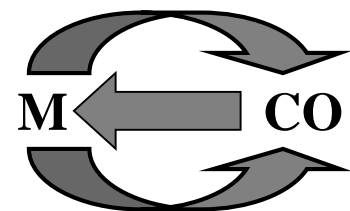
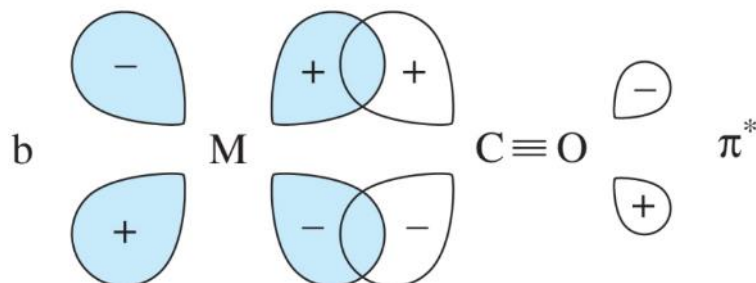

“synergetic effect“

Aus "Allgemeine und Anorganische Chemie" (Binnewies, Jäckel, Willner, Rayner-Canham), erschienen bei Spektrum Akademischer Verlag, Heidelberg, © 2004 Elsevier GmbH München. Abbildung23-29.jpg

7. Principals in Coordination Chemistry

From Crystal to Ligand Field

Explanation of ligand ordering in the spectrochemical series



Strong ligands

π -back binding

Weak ligands

no π -back binding

The spectrochemical series does not correlate with the charge of the ligands but with the ability of the ligands to delocalise electron density from the metal atom and thus to enhance the positive charge density or the effective field strength at the metal atom.

π -acceptor-ligands:
(back-binding)

Stabilise metals in low oxidation states \Rightarrow CO, NO, CN^- , CN_2^{2-}
 O_2 , N_2

π -donor-ligands:
(Metal-ligand-multiple bonds)

Stabilise metals in high oxidation states \Rightarrow O^{2-} , N^{3-}

7. Principals in Coordination Chemistry

Molecular Orbital (MO) Theory

- ⇒ Overlap of metal and ligand orbitals leads to formation molecular orbitals
- ⇒ Example: octahedral complex built up by **6 σ -donor ligands** and **3d-metal atom**

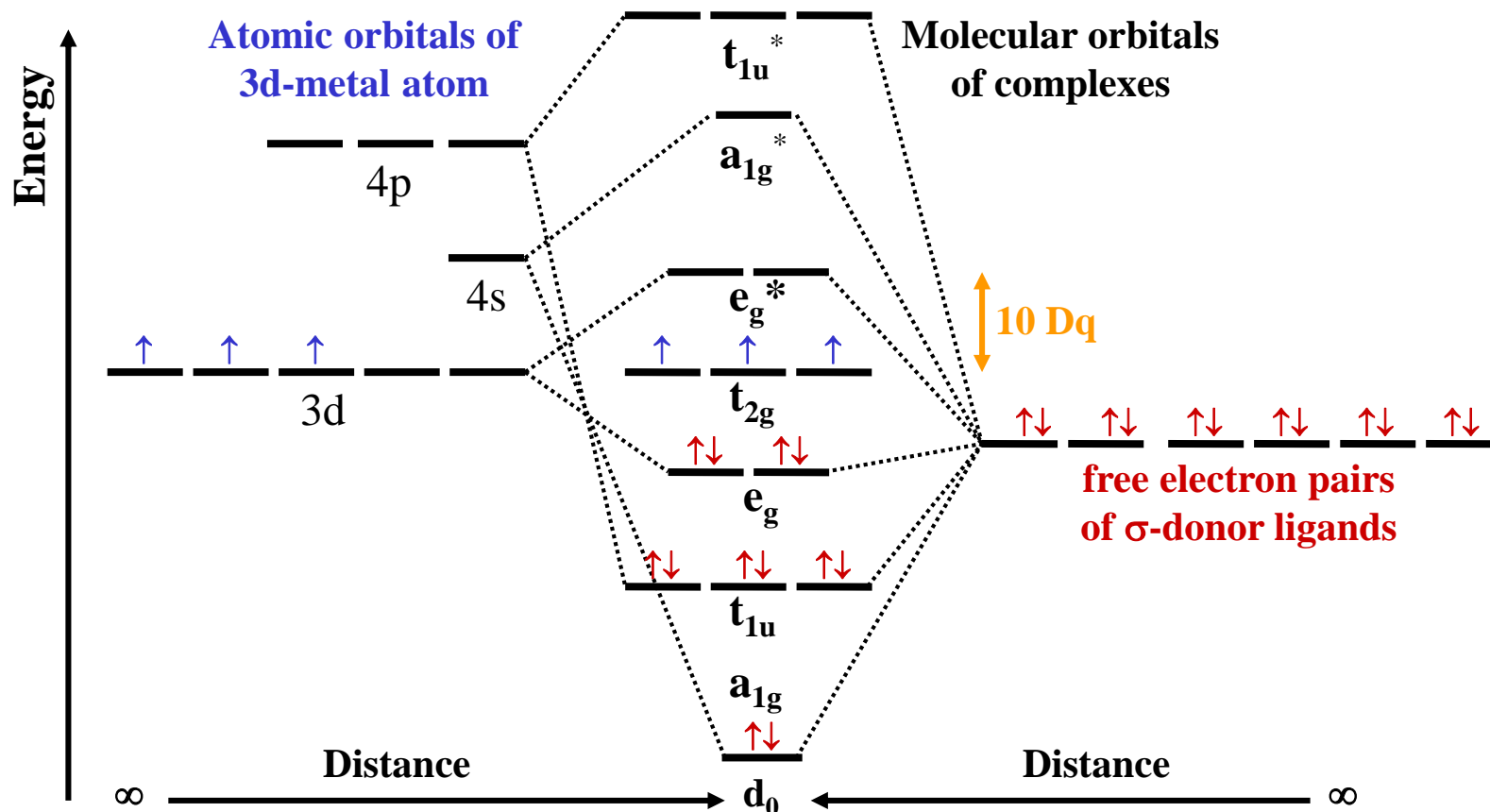

7. Principals in Coordination Chemistry

Molecular Orbital (MO) Theory

Effects of π -back binding

- Strengthening of metal-ligand-bond
- Enhanced crystal field splitting by lowering the energy of the t_{2g} -orbitals
- Weakening of intra-ligand bonding through transfer of electron density into anti-bonding molecular orbitals of the ligand
 - ⇒ decreased vibrational frequencies
 - ⇒ increased reactivity of the ligands (activation)
 - ⇒ catalytic and enzymatic reactions

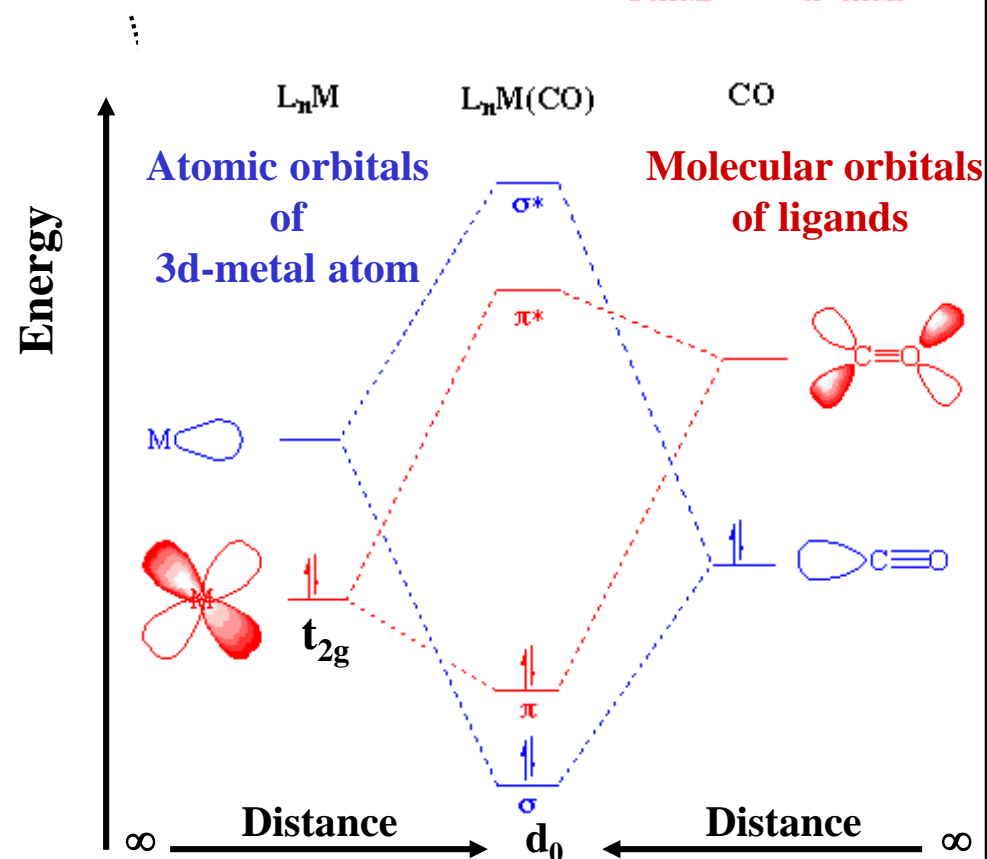
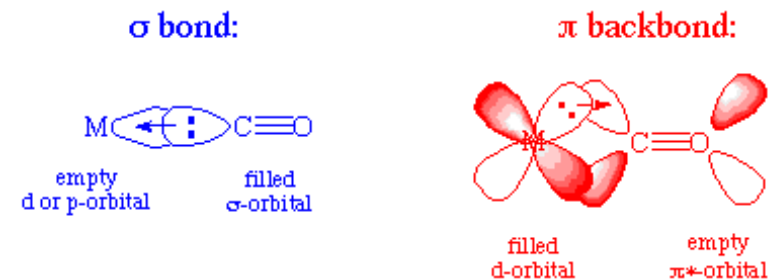

7. Principals in Coordination Chemistry

Molecular Orbital (MO) Theory

Explanation of ligand ordering in the spectrochemical series

$\text{CO} > \text{CN}^- > \text{NO}_2^- > \text{en} > \text{NH}_3 > \text{H}_2\text{O} > \text{OH}^- > \text{F}^- > \text{NO}_3^- > \text{Cl}^- > \text{SCN}^- > \text{S}^{2-} > \text{Br}^- > \text{I}^-$

Strong ligands

unoccupied π^* -orbitals

π -acceptor ligands

no suitable p-orbitals

pure σ -donor ligands

Weak ligands

occupied p-orbitals

π -donor ligands

<u>Type of ligand</u>	<u>Effect on metal-ligand-bond</u>	<u>Cristal field splitting</u>
π -acceptor	highly stabilizing	high
σ -donor	stabilizing	intermediate
π -donor	destabilizing	small

8. Properties of Biomolecules

Biological Molecules – Overview and Quantities in a Typical Eukaryotic Cell

• Water			70%
• Proteins	→	Polypeptides → Amino acids	15%
– Structural proteins			
– Transportational proteins			
– Storage proteins			
– Sphere proteins (enzymes)			
• Nucleic acids	→	Polynucleotides → Phosphate + Bases + Desoxyribose	
– DNA			1%
– RNA			6%
• Starch/cellulose	→	Polysaccharides → aldoses/ketoses	3%
• (Phospho)lipids	→	Glycerine + fatty acids (+ phosphates)	2%
• “Monomers“	→	Prosthetic groups, Co-factors	2%
• Inorganic ions	→	Na ⁺ , K ⁺ , Mg ²⁺ , Ca ²⁺ , Fe ⁿ⁺ , Mn ⁿ⁺ , Co ⁿ⁺ , Cu ⁿ⁺ , Zn ²⁺ , F ⁻ , Cl ⁻ , HCO ₃ ⁻ , PO ₄ ³⁻ , MoO ₄ ²⁻ , WO ₄ ²⁻	1%
• Other “inorganics”		O ₂ , CO ₂ , CO, NO, CN ⁻ , OCN ⁻ , H ₂ O ₂ ,	ppm-ppb

8. Properties of Biomolecules

Water → Solvents ⇒ Biochemistry = “Aqueous Chemistry”

- Auto-proteolysis: $2 \text{H}_2\text{O} \rightleftharpoons \text{H}_3\text{O}^+ + \text{OH}^-$ $\text{pK}_a (25 \text{ }^\circ\text{C}) = 14.0$
- High dipole moment: $\mu = q \cdot d = 1.85 \text{ Debye [Cm]}$
⇒ High polarity and strong H-bridges
- Optical transparency about 200 – 800 nm
⇒ absorption in the IR- as well as VUV/EUV-range
- Metal cations increase acidity of water

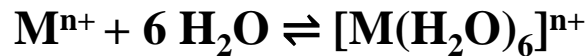

Metal cation $\text{pK}_a (25 \text{ }^\circ\text{C}, 0.1 \text{ M})$

Ca^{2+} 13.4

Mn^{2+} 11.1

Cu^{2+} 10.7

Zn^{2+} 10.0

Fe^{3+} 2.2

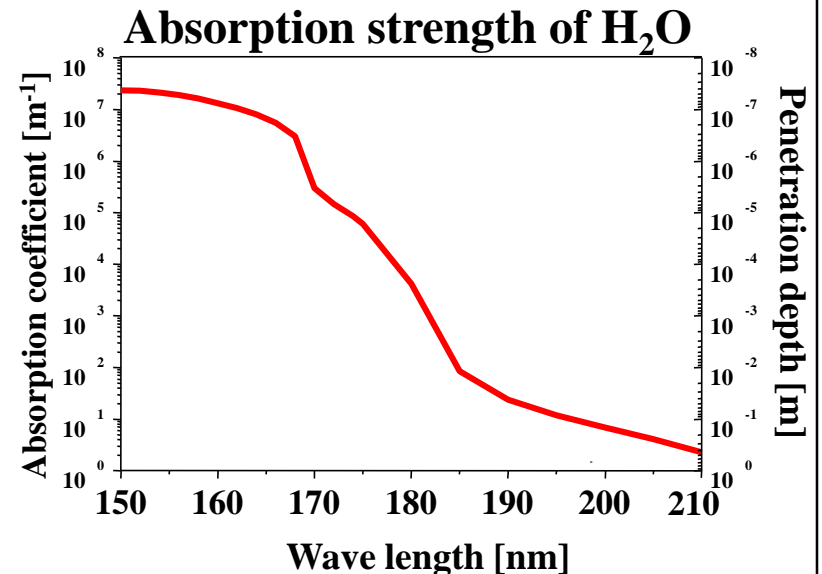
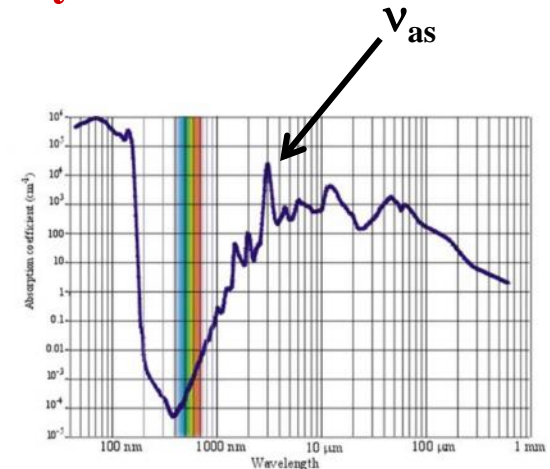

8. Properties of Biomolecules

Proteins: Structure

Proteins are built up from one or multiple polypeptide sequences, which, themselves, are formed by the combination of amino acids.

The reaction leads to acid amides and is called peptide bond.

Amino acids (AS) $^{-}\text{OOC}-\text{CH}(\text{R})-\text{NH}_3^{+}$

↓
Polypeptides (100 – 100000 AS, $M = 10^5 - 10^8$ g/mol)

↓
Proteins (one or multiple polypeptide chains)

↓
Holo protein (= protein + prosthetic group)

→ Metal proteins

→ Metal holo proteins

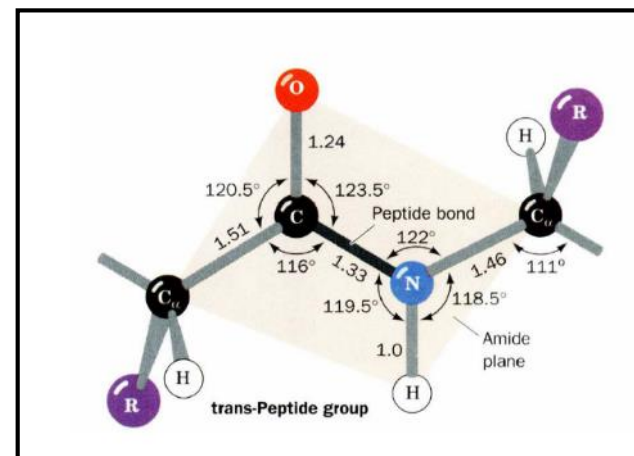

8. Properties of Biomolecules

Proteins: Formation and Structure

1. Linkage of amino acids to polypeptides (primary structure)

The synthesis takes place in the ribosomes (AS-sequence is determined by m-RNA)

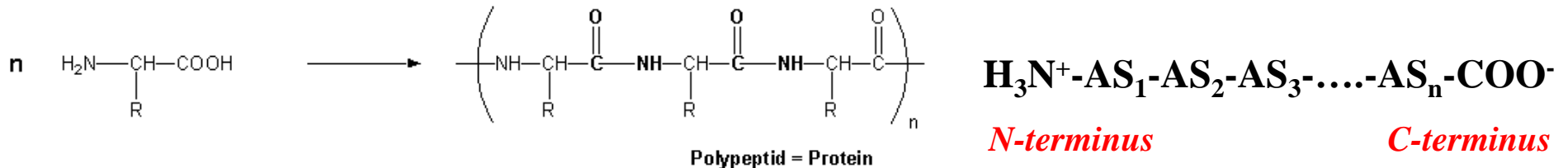
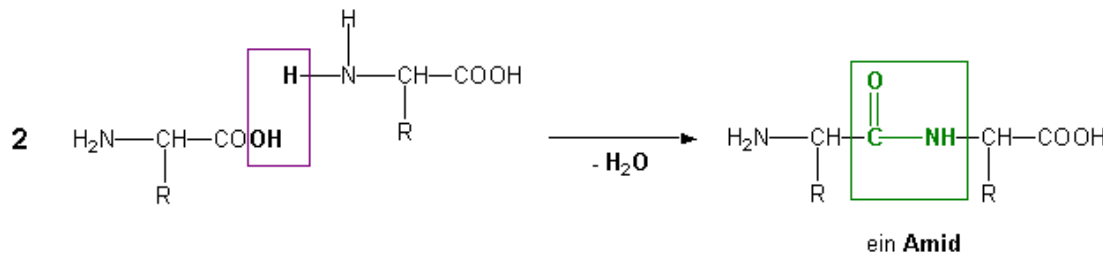

2. Folding of polypeptides to 3-dimensional constructions (secondary and tertiary structure)

- by van-der-Waals interactions (steric)
- by ionic interactions (electrostatic) \Rightarrow stabilisation via metal cations
- by hydrogen bonds (weak bonding)
- by disulphide bridges R-S-S-R (strong bonding)

8. Properties of Biomolecules

Proteins: Secondary Structure

Hydrogen bridges and other interactions lead to secondary structures

α -Helices

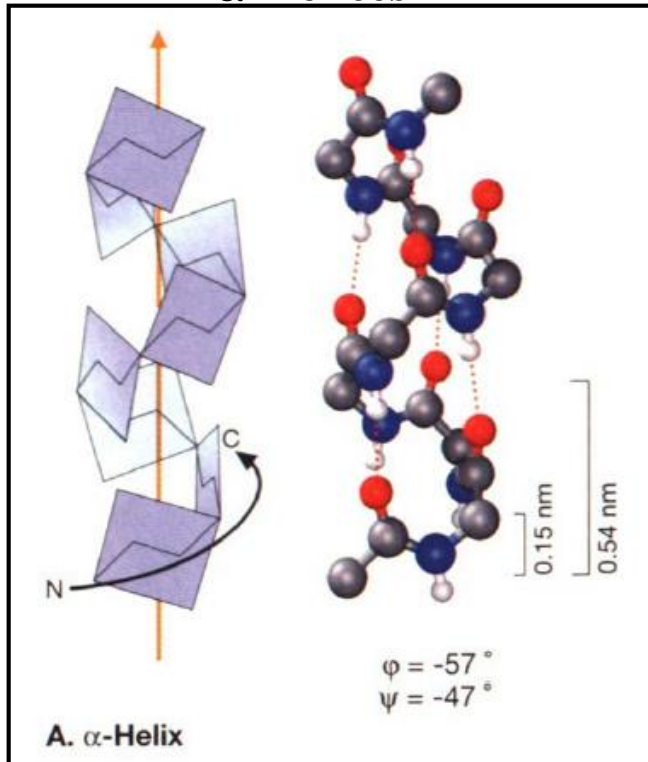

β -sheets

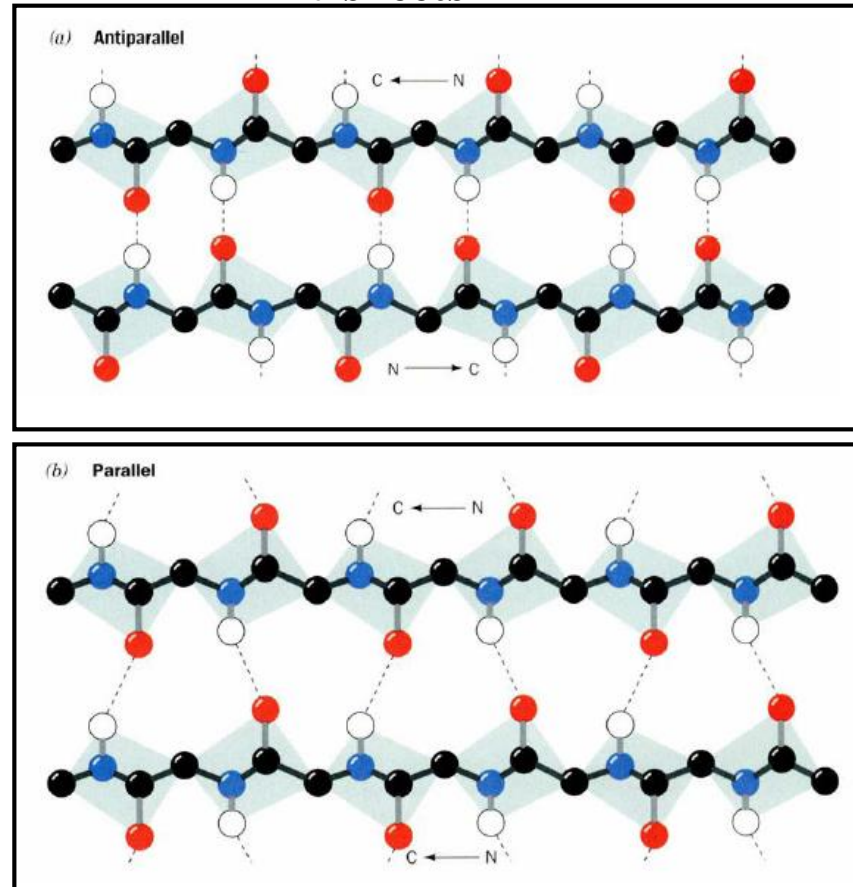

Collagens (triple helix)

α -keratins (2 x double helix)

8. Properties of Biomolecules

Proteins: Disulphide Bridges R-S-S-R'

Enzymatic formation: $R-SH + HS-R \rightarrow R-S-S-R + 2 H^+ + 2 e^-$

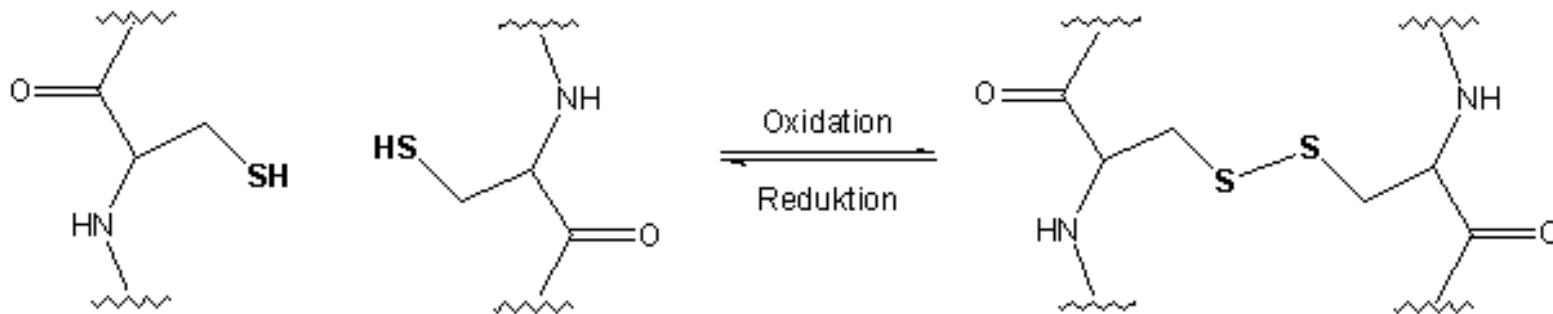

Disulphide bridges can link AS within a chain or between two chains

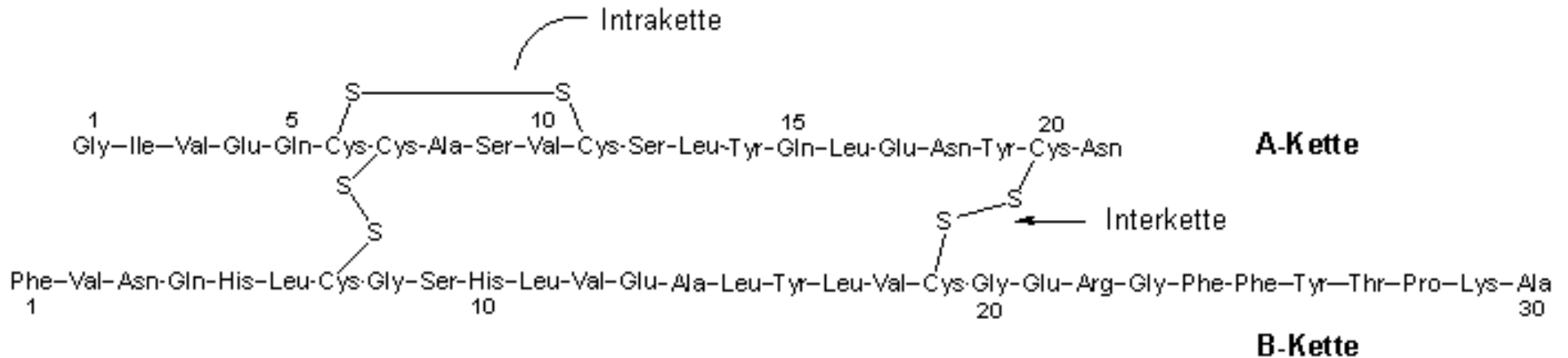

8. Properties of Biomolecules

Proteins: Tertiary and Quaternary Structure

Tertiary structure: three dimensional structure of a single polypeptide chain

Quaternary structure: arrangement of multiple polypeptide chains in a protein

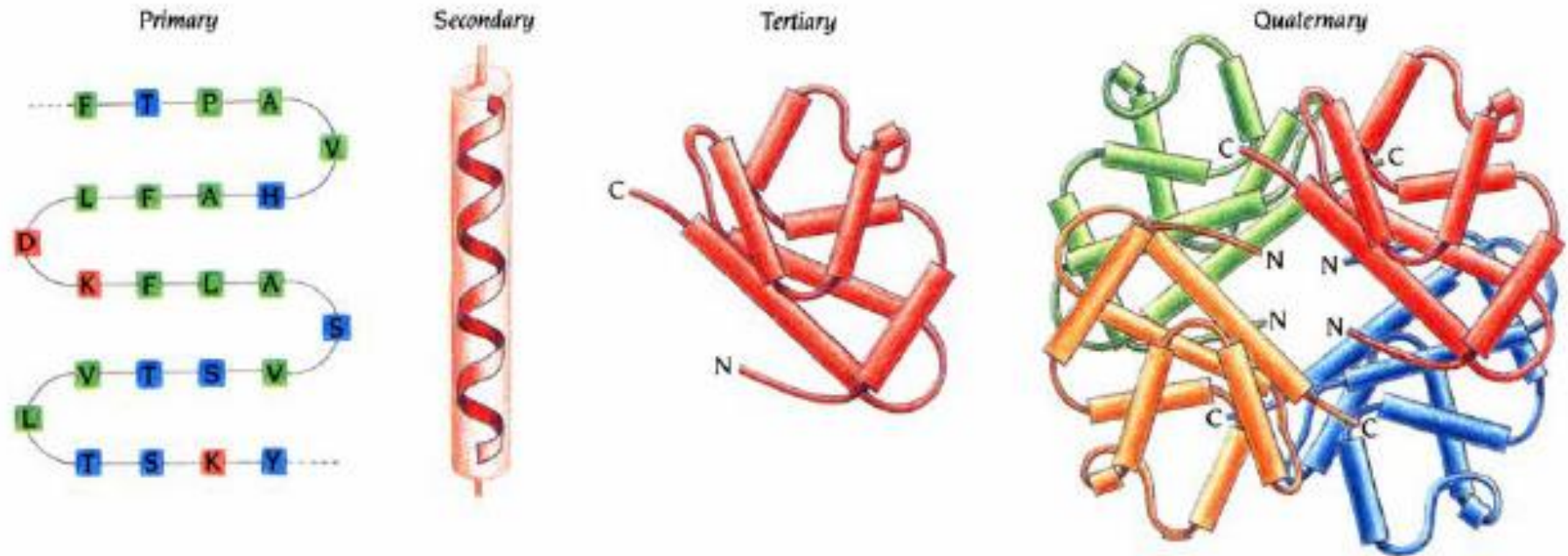

8. Properties of Biomolecules

Proteins: Properties

Physical

- **Stability:** low (enzymes) till high (horn)
- **Temperature sensitivity** \Rightarrow denaturation upon heating
- **Some proteins are insoluble,**
some give colloidal solutions

Solutions of proteins are optically active

- **Absorption in UV-range**
Aliphatic < 240 nm
Aromatic < 320 nm

Chemical

- **Hydrolysis upon heating in combination with acids or bases:**
Polypeptide \rightarrow amino acids
- **Cleavage by proteases (at defined interfaces)**
 \Rightarrow sequence analysis

after Wetlauffer, Ad. Prot. Chem. 17:303 (1962)

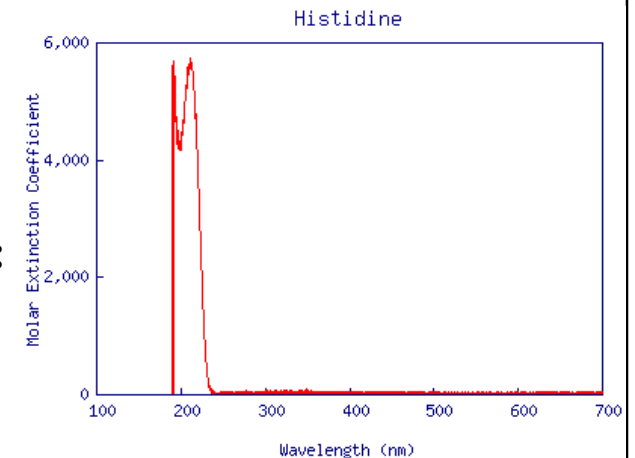
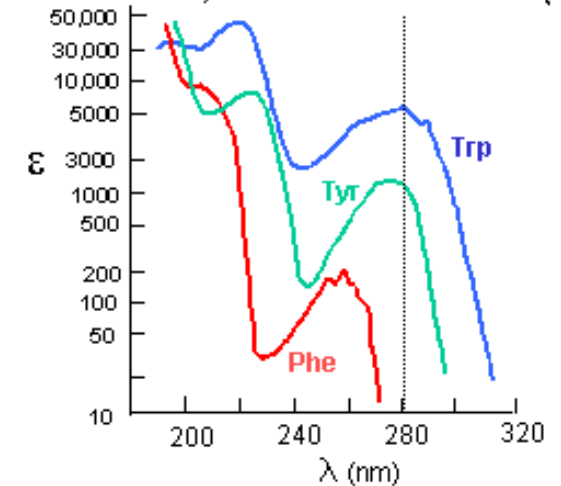

8. Properties of Biomolecules

Proteins: Functions

Structural proteins

- Collagen
- α -keratins, β -keratins

Transportation and storage proteins

- Oxygen transport: heme- and myoglobin
- Storage of iron: ferritin and ferredoxine

Sphere proteins (enzymes)

- Oxidoreductases \rightarrow redox reactions (e.g. catalysis)
- Transferases \rightarrow transfer of small molecular groups (e.g. hexokinases)
- Hydrolases \rightarrow hydrolysis of proteins, sugars and lipids (e.g. amylases, ureases, trypsin)
- Lyases \rightarrow addition reactions of small molecules at double bonds (e.g. citrate synthase)
- Ligases \rightarrow linkage of small molecules to bigger units (e.g. DNA ligase)
- Isomerases \rightarrow alteration of molecular constitution (e.g. phosphoglucose isomerase)

TEM-images
of collagen fibres

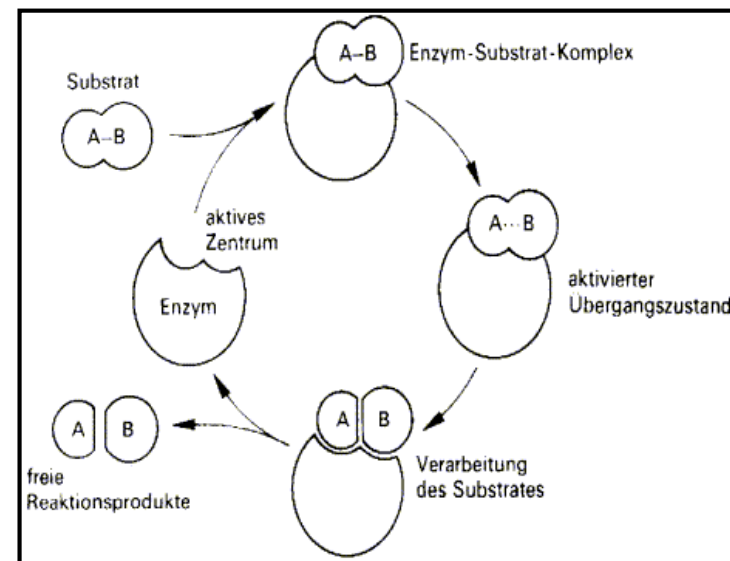
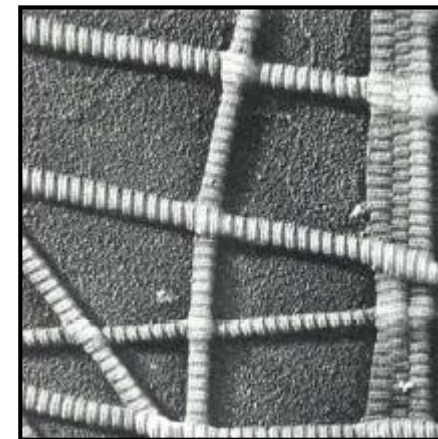

8. Properties of Biomolecules

Proteins: Function of the Zn^{2+} -Enzyme, Carbonic Anhydrase

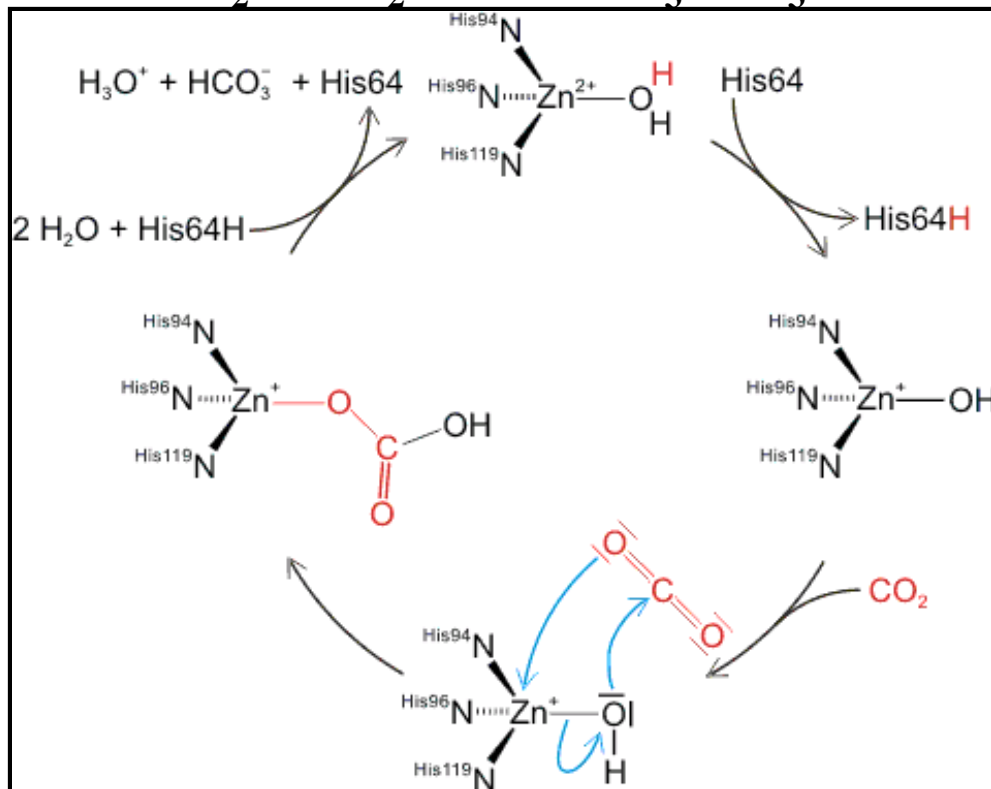
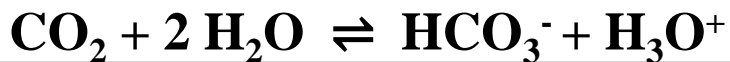

A lot of other Zn-enzymes also catalyse hydrolysis of polar bonds, such as proteases and esterases

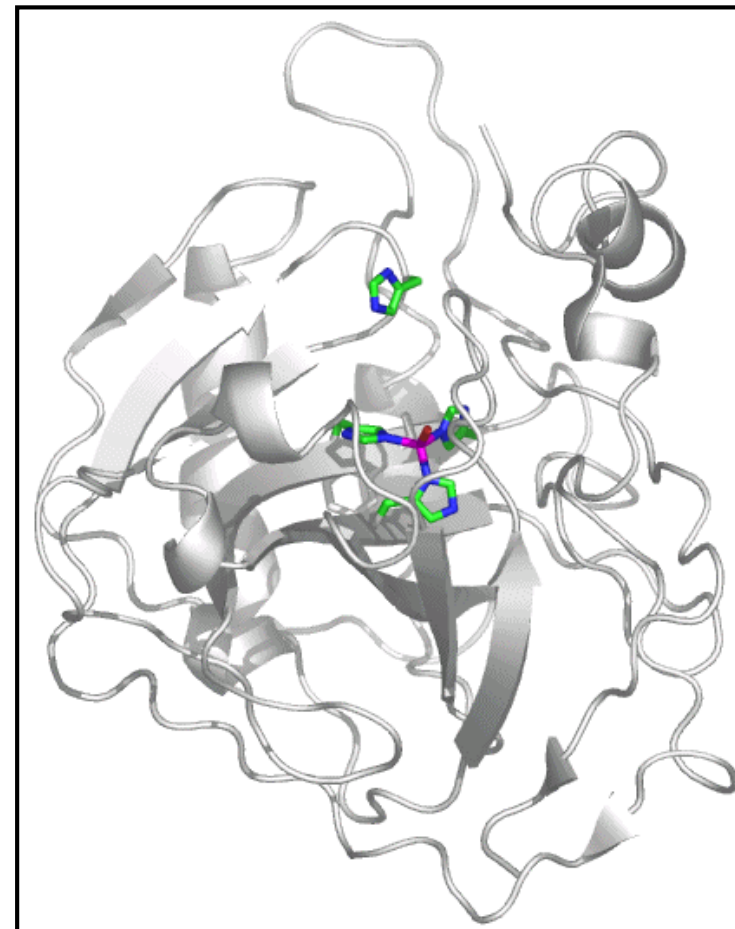

Single-stranded protein consisting of 260 amino acids

8. Properties of Biomolecules

Nucleic Acids: Building Blocks

During hydrolysis of a nucleic acid sugar, phosphate and amine-bases are formed:

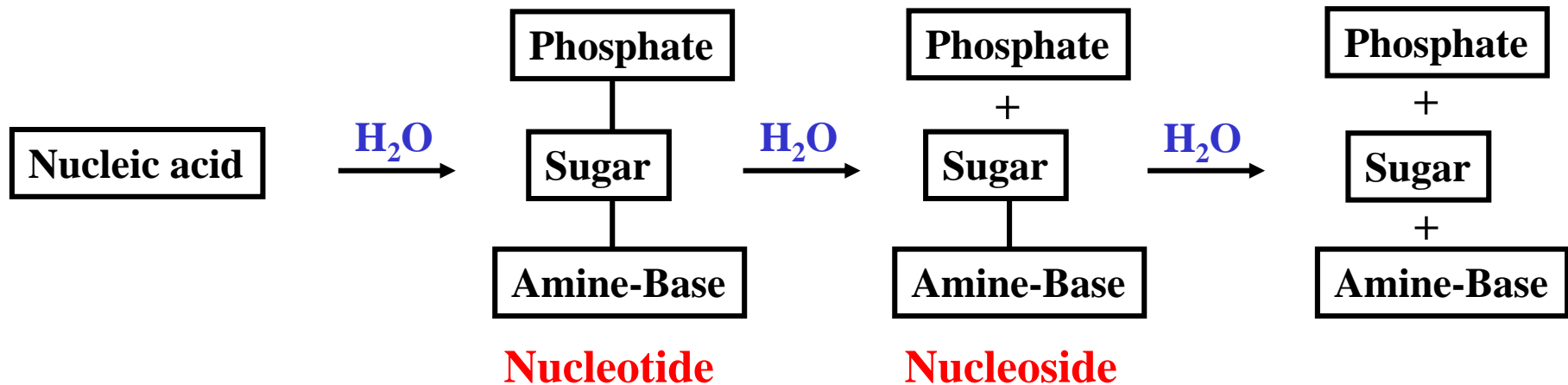

Nucleic acids	Sugar	Amine bases
DNA	2-desoxyribose	cytosine, thymine, adenine, guanine
RNA	D-ribose	cytosine, uracil, adenine, guanine

8. Properties of Biomolecules

Nucleic Acids: Building Blocks

Sugar

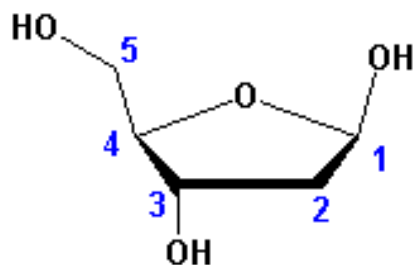

2-deoxyribose

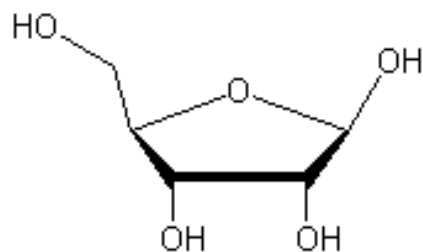

D-Ribose

Amine bases

Metal-binding-positions

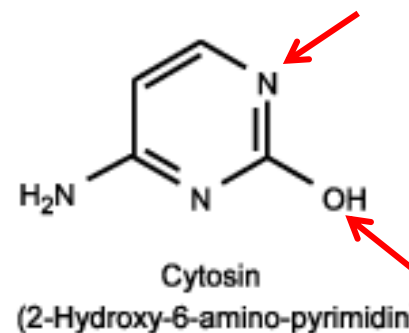
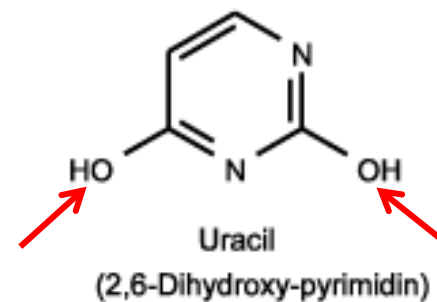
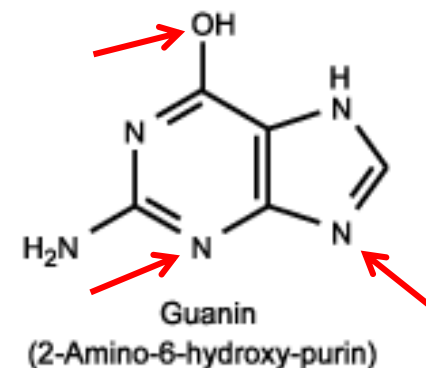
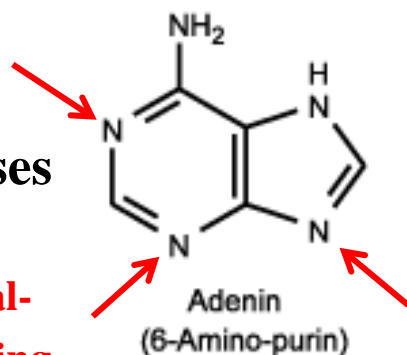

⇒ Unstable against hydrolysis

8. Properties of Biomolecules

DNA: Nucleosides and Nucle

dAMP =
desoxyadenosine-
monophosphate

dGMP =
desoxyguanosine-
monophosphate

dCMP =
desoxycytidine-
monophosphate

dTMP =
desoxythymidine-
monophosphate

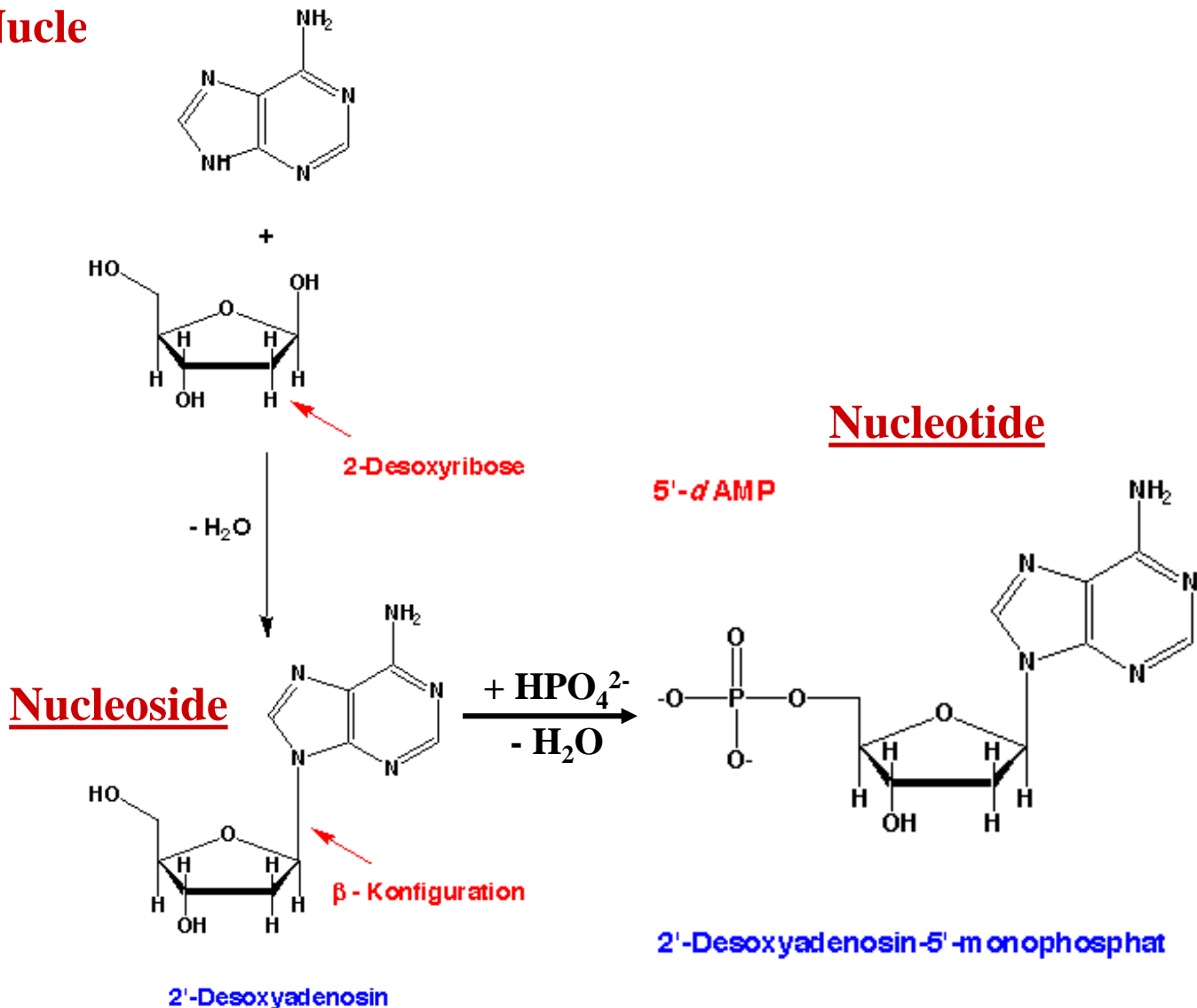

8. Properties of Biomolecules

DNA: Primary Structure (Sequence)

A polymer chain is formed through the continuous linkage of phosphate ester bridges between the C5 of the sugar unit from one nucleotide to the C3 of another sugar

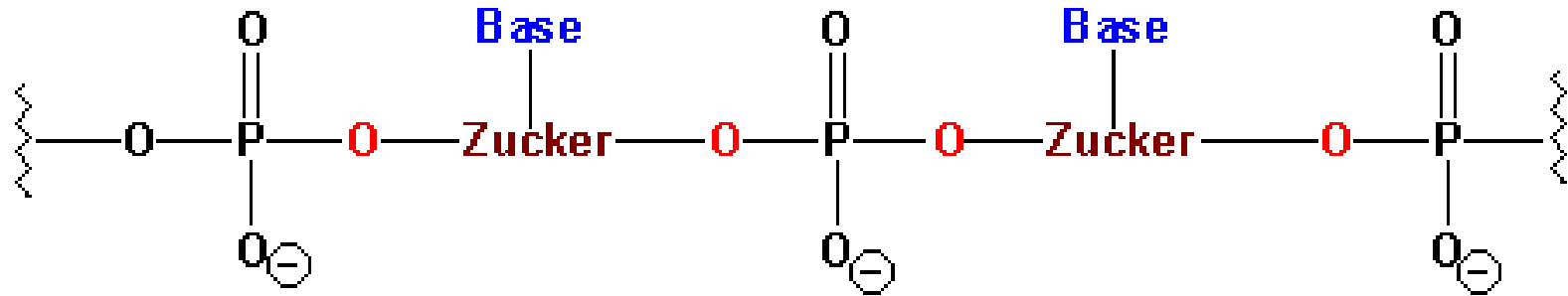

One end of the polymer chain possesses a free hydroxyl group at the C3' (3'-end) and the other possesses another phosphate unit at C5 (5'-end)

8. Properties of Biomolecules

DNA and RNA: Structure

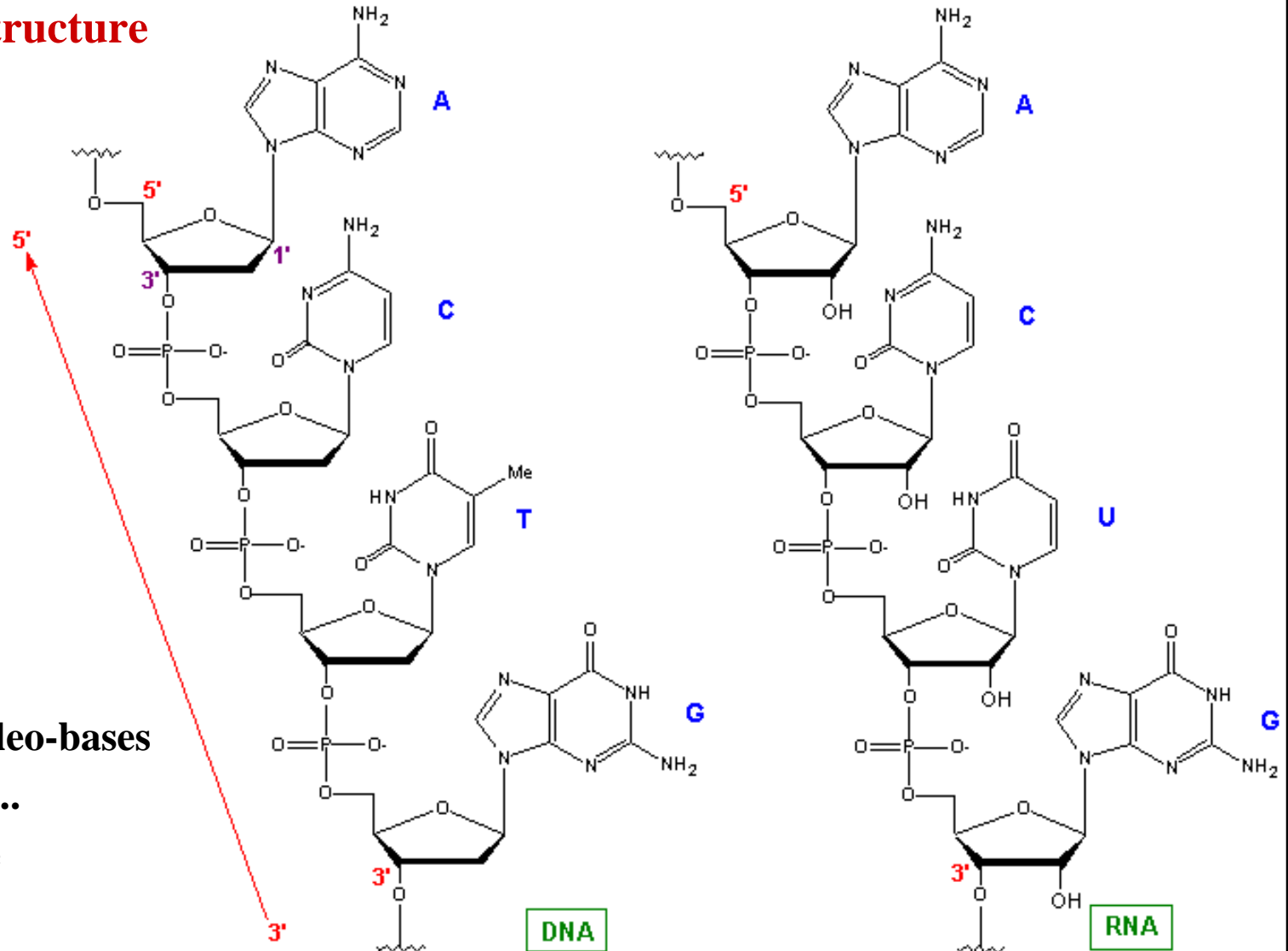

Hetero atoms of nucleo-bases

→ Cu^{2+} , Cr^{3+} , Pt^{2+} , ...

Phosphate backbone

→ Mg^{2+} , Na^+ , K^+

8. Properties of Biomolecules

DNA and RNA: Chemical Properties

For acidic hydrolysis
A strong acid is needed

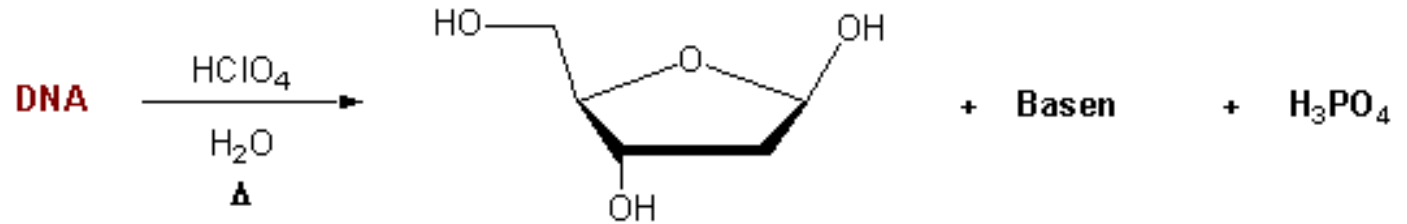

In basic conditions DNA
is relatively stable, whereas
RNA is rapidly cleaved

(cyclic phosphor-
acid ester)
DNA misses the hydroxyl
Group at **C2**

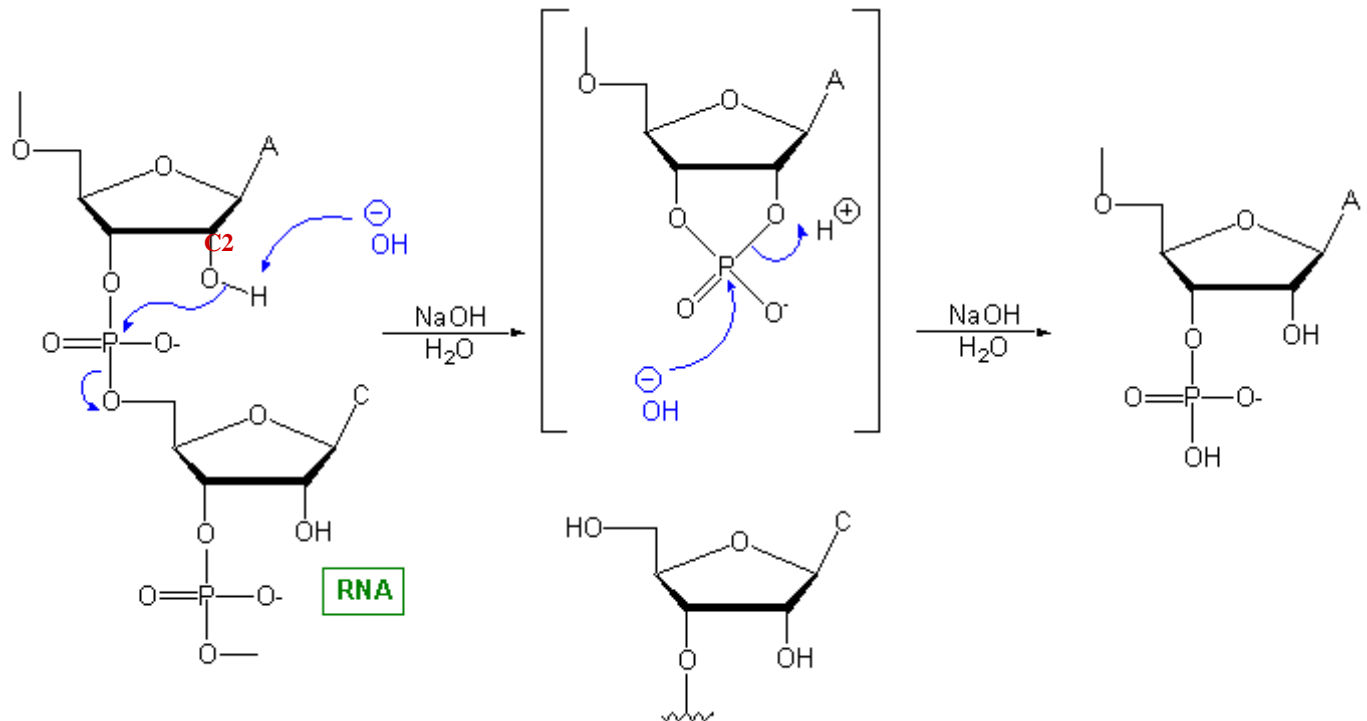

8. Properties of Biomolecules

DNA: Secondary Structure Suggested in 1953 by James D. Watson & Francis Crick

- DNA is a double helical structure, consisting of two strands with complementary base sequences
- The ratio of A to T and G to C is always one to one
- The bases A and T as well as the bases G and C are linked via hydrogen bonds

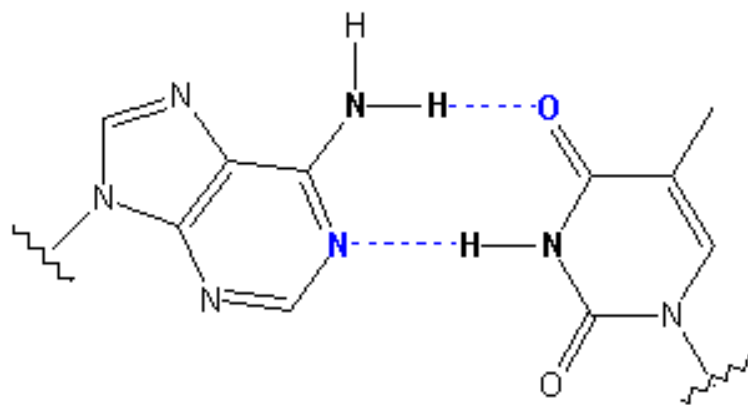
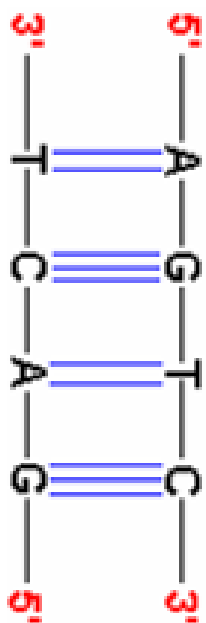
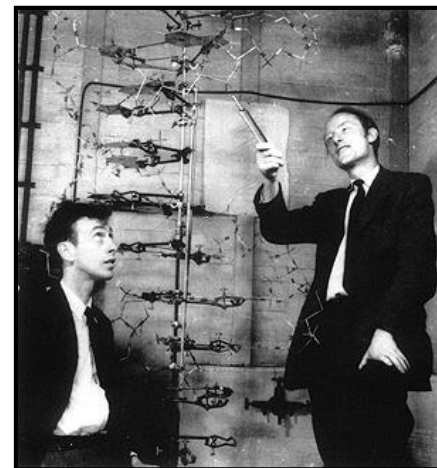

$$\Delta G^\circ \sim -1.2 \text{ kcal/mol}$$

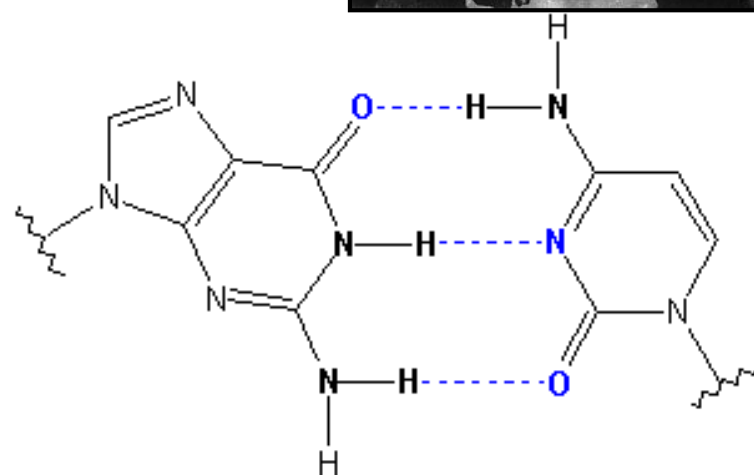

$$\Delta G^\circ \sim -2.4 \text{ kcal/mol}$$

8. Properties of Biomolecules

DNA: Secondary Structure Is a Double Helix

Due to structural reasons, the arrangement, where hydrogen bonds are optimally formed and sterical hindrance is minimized, is a double helix

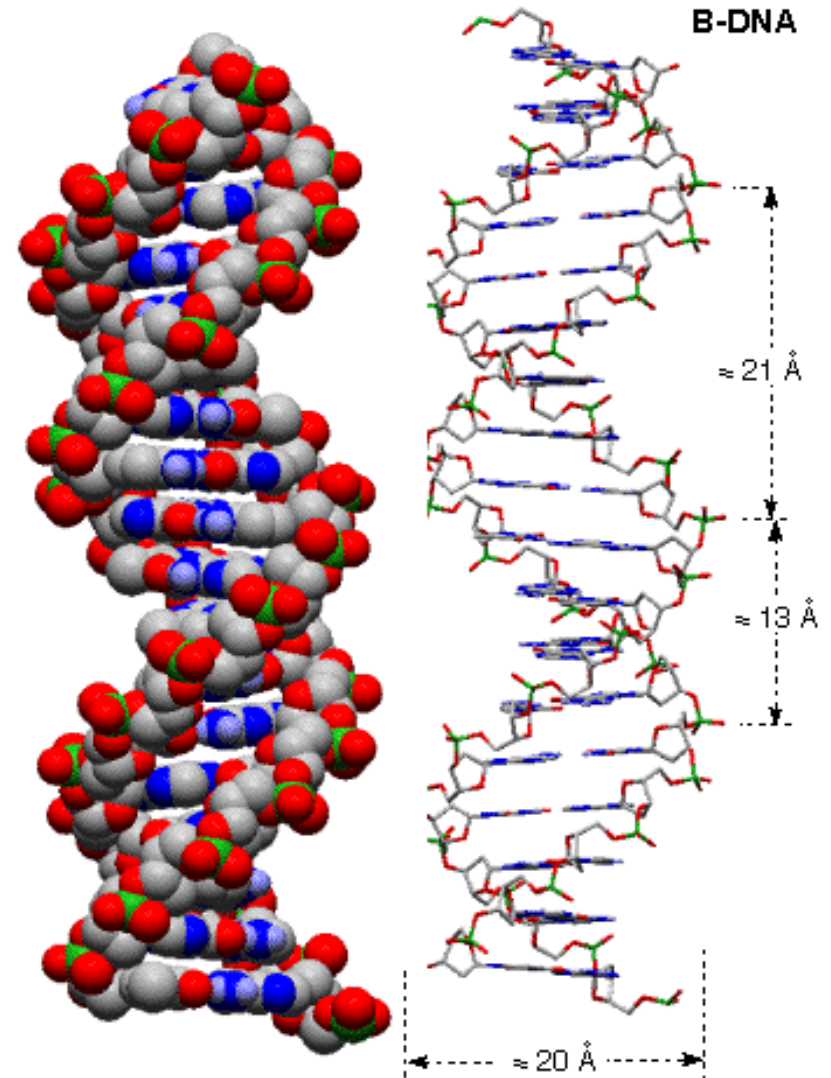
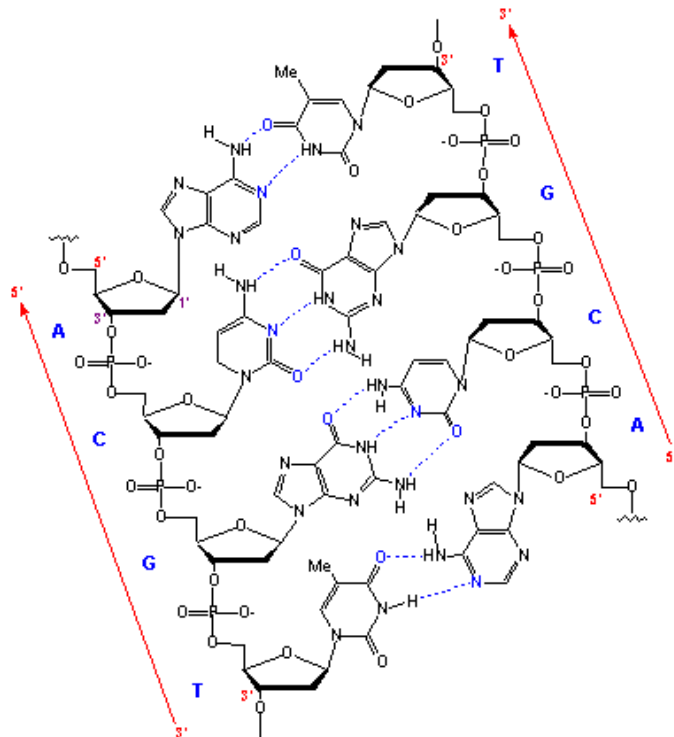

8. Properties of Biomolecules

DNA: Secondary Structure A-, B-, and Z-DNA

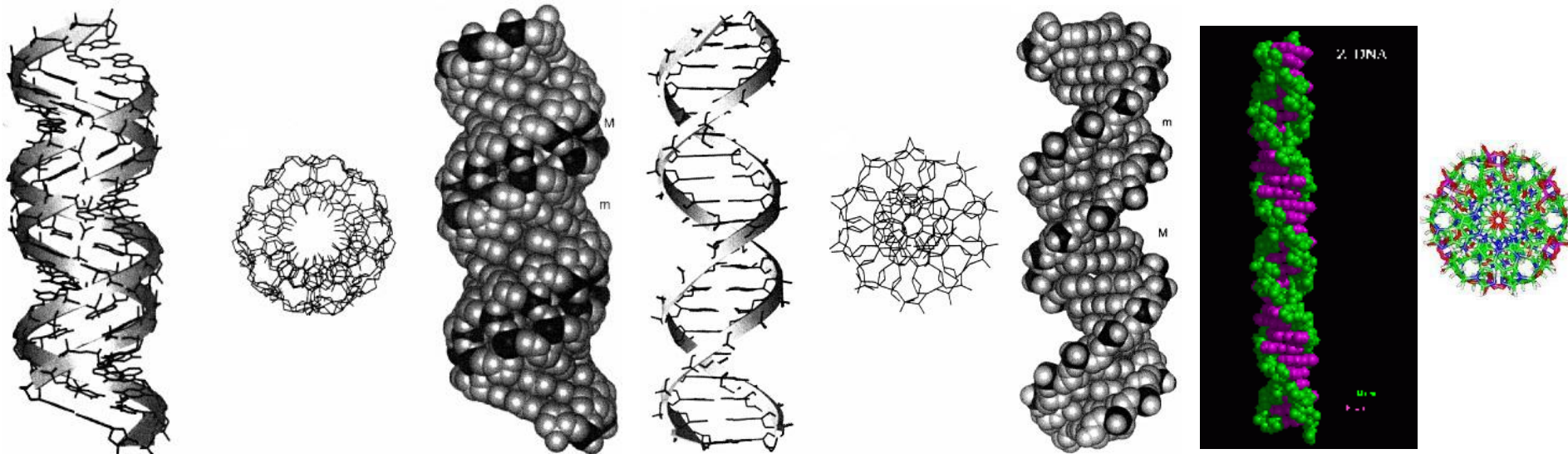

Parameter	A-DNA	B-DNA	Z-DNA
Form	broad	intermediate	narrow
Increase per Bp [nm]	0.23	0.34	0.38
Helix diameter [nm]	2.6	2.4	1.8
Sense of rotation	right	right	left
Bp per helical turn	11	10.4	12
Pitch [nm]	2.5	3.5	4.7
Angle Bp towards helical axis	19°	1°	9°

Source: Neidle, Stephen, *Nucleic Acid Structure and Recognition*, Oxford University Press, 2002, p. 36.

8. Properties of Biomolecules

Spectroscopic Properties of Nucleo Bases

Absorption bands at 265 nm (A, T, C, G) and at 240 nm (G)

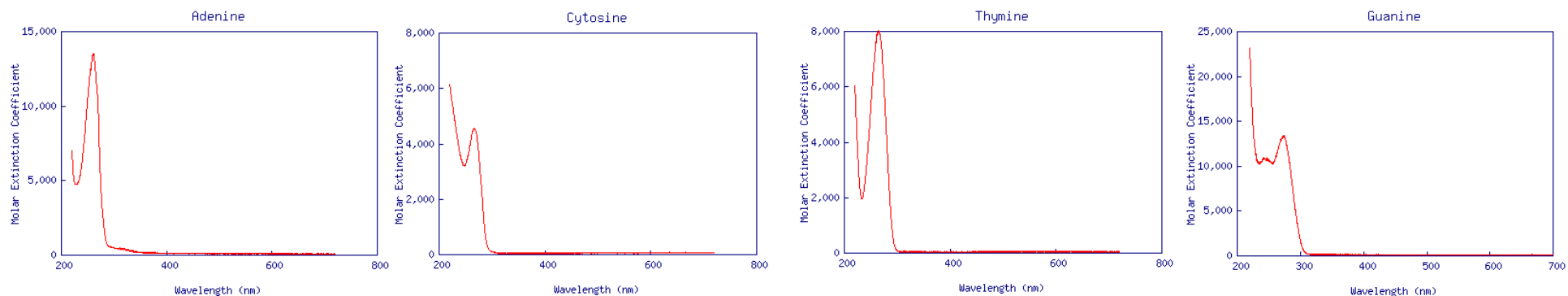

Other biomolecules, that are absorbing even in the near-UV or blue spectral range are

NAD(P)H or FADH₂

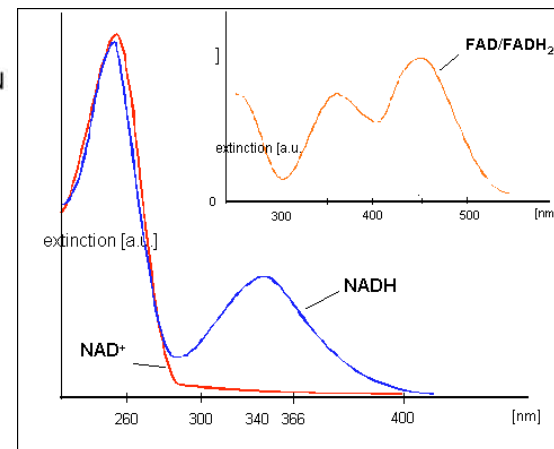
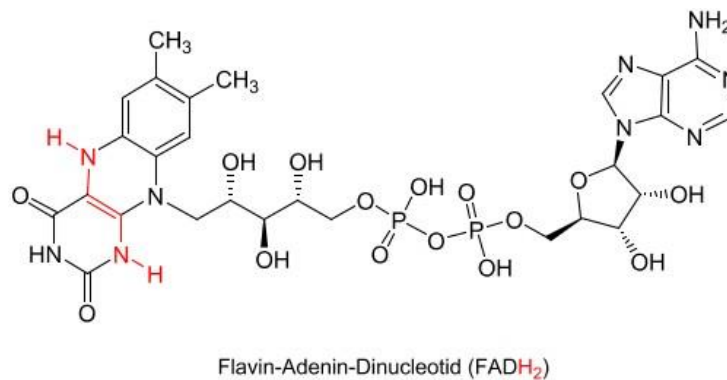
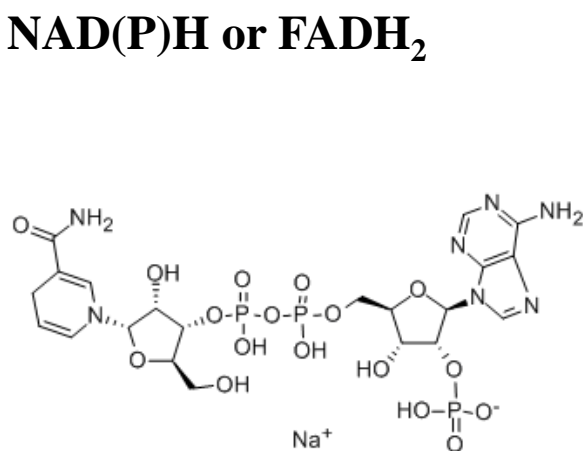

8. Properties of Biomolecules

Spectroscopic Properties of Nucleo-Bases

Species	λ_{\max} [nm]	ϵ [l \cdot mol $^{-1}$ cm $^{-1}$]	Transition
Adenine	260	13400	n- π^* , π - π^*
Guanine	275	8100	n- π^* , π - π^*
Cytosine	267	6100	n- π^* , π - π^*
Thymine	264	7900	n- π^* , π - π^*
AMP	260	15500	n- π^* , π - π^*
ss-poly-AMP	260	10600	n- π^* , π - π^*
ds-poly-AMP	258	9600	n- π^* , π - π^*

Absorption spectrum of TMP

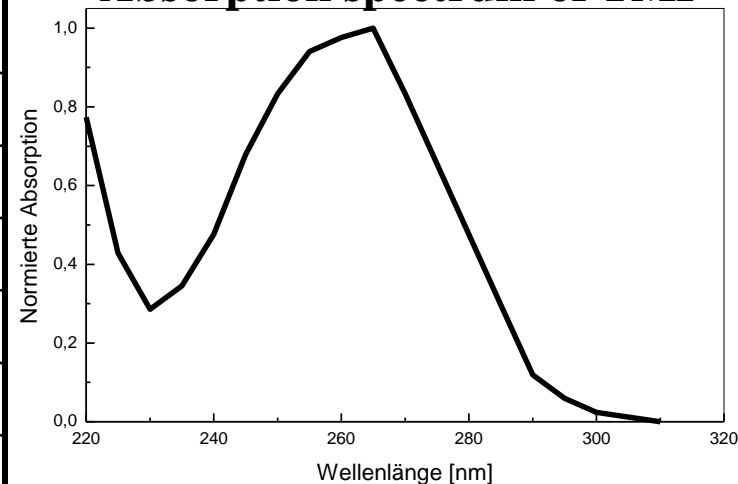

Sylvia S Mader, Biology, 6th edition. © 1998 The McGraw-Hill Companies, Inc. All rights reserved.

Information from the UV-absorption spectrum

- AT- and GC-content
- Single or double helix
- Thermal stability of DNA
- Melting point of DNA
(temperature when double helix is cleaved)

Chargaff's DNA Data Base Composition in Various Species (%)

Species	A	T	G	C
<i>Homo sapiens</i>	31.0	31.5	19.1	18.4
<i>Drosophila melanogaster</i>	27.3	27.6	22.5	22.5
<i>Zea mays</i>	25.6	25.3	24.5	24.6
<i>Neurospora crassa</i>	23.0	23.3	27.1	26.6
<i>Escherichia coli</i>	24.6	24.3	25.5	25.6
<i>Bacillus subtilis</i>	28.4	29.0	21.0	21.6

8. Properties of Biomolecules

Spectroscopic Properties of Nucleo Bases

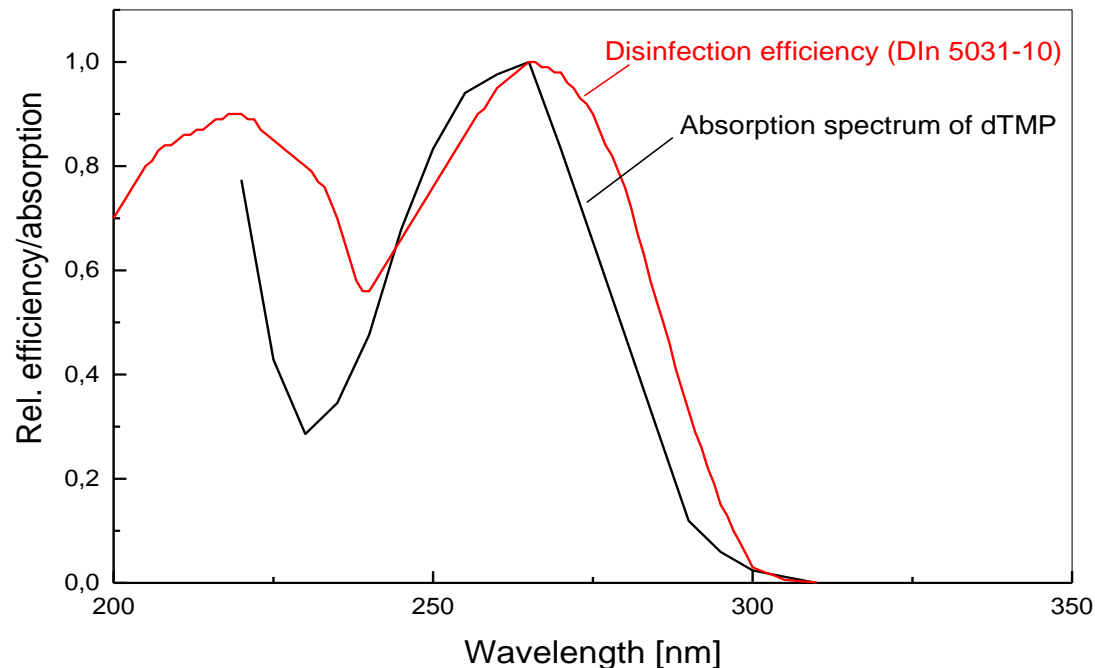

<u>Nucleotide</u>	<u>Extinction coefficient ϵ at 260 nm</u>
dAMP	15200 $\text{Imol}^{-1}\text{cm}^{-1}$
dTMP	8400 $\text{Imol}^{-1}\text{cm}^{-1}$
dGMP	12000 $\text{Imol}^{-1}\text{cm}^{-1}$
dCMP	7100 $\text{Imol}^{-1}\text{cm}^{-1}$

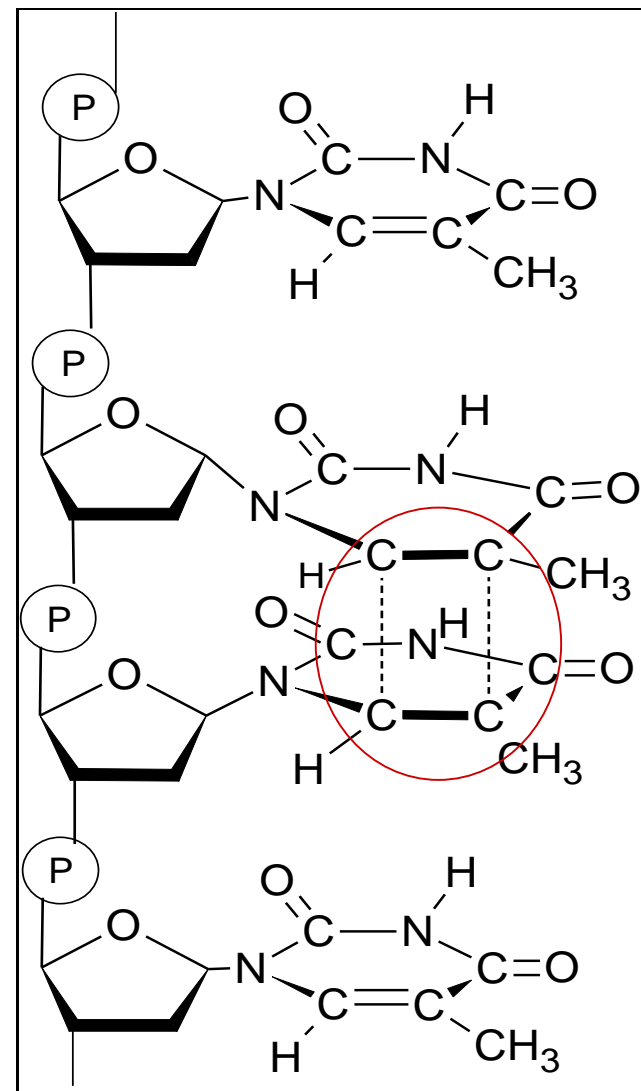

8. Properties of Biomolecules

Spectroscopic Properties of Nucleo-Bases

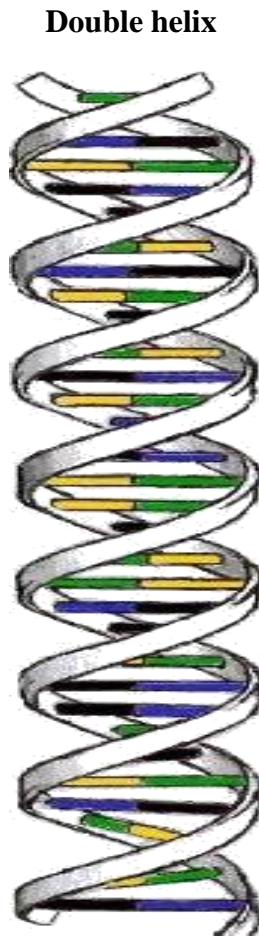
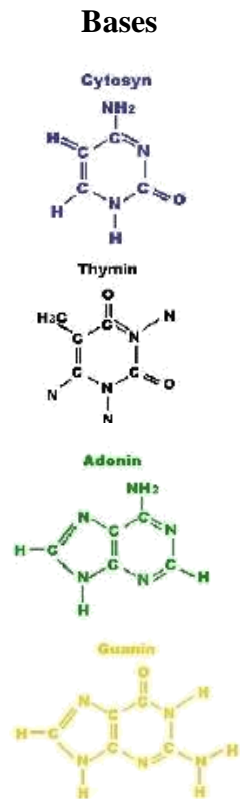

Sugar and phosphate units

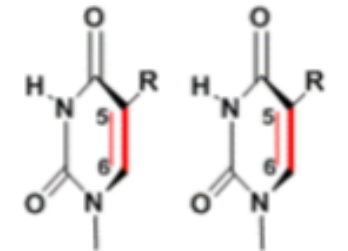

adjacent thymine bases

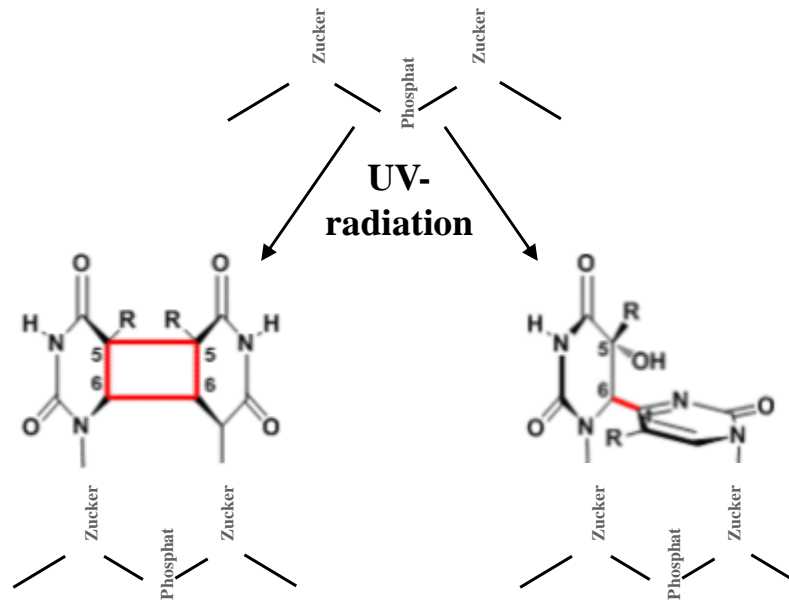

Cyclobutane pyrimidine dimer (CPD) 70-80%
[2+2]-Cyclo addition

Pyrimidine pyrimidone photoproduct (64PP) 20-30%
[2+6]-cyclo addition + ether cleavage

8. Properties of Biomolecules

Nucleoside-5'-monophosphates Form Diphosphates and Triphosphates, too

⇒ ATP is the most important energy source for all cellular activities

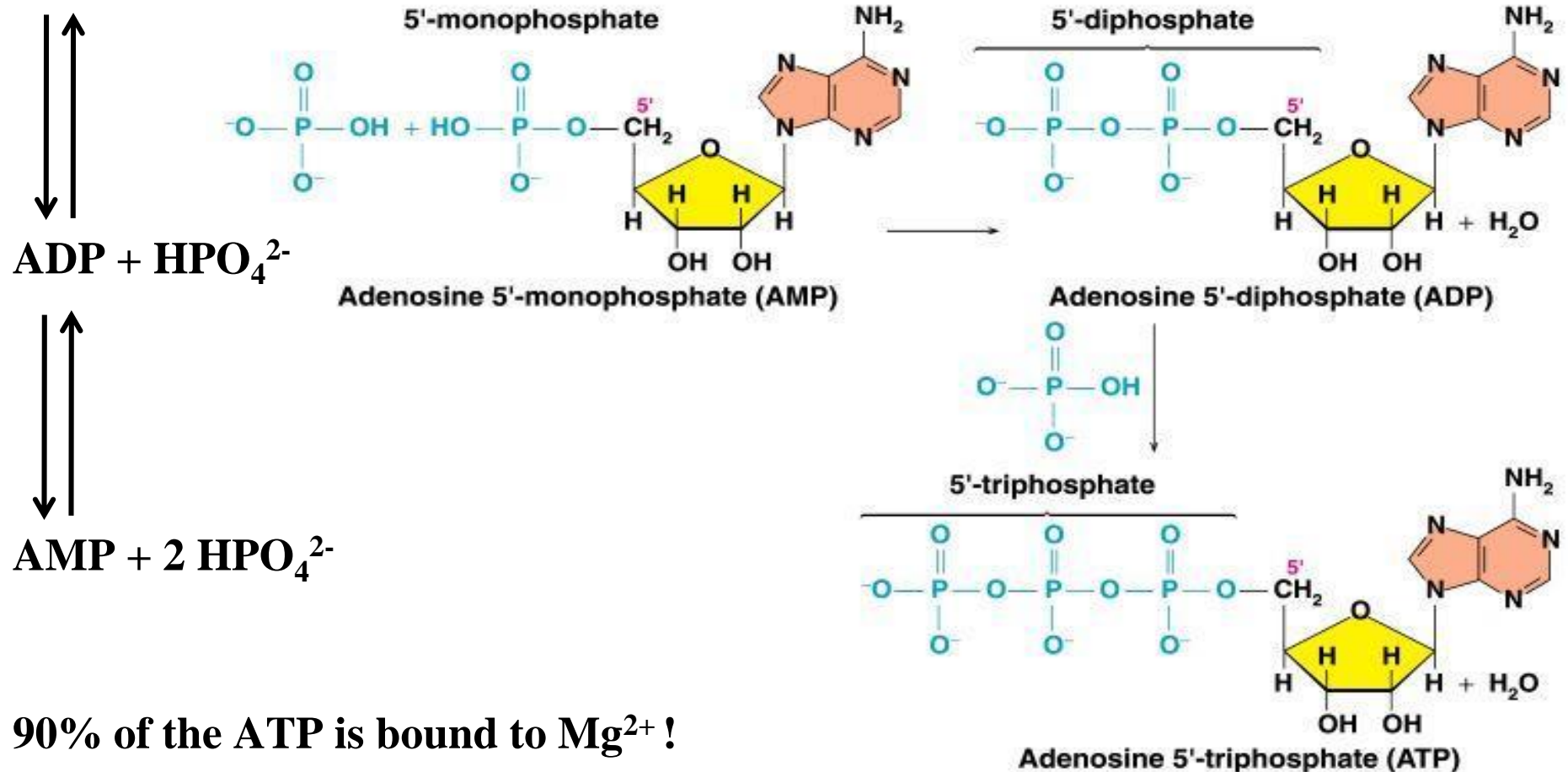

⇒ 90% of the ATP is bound to Mg^{2+} !

8. Properties of Biomolecules

Carbohydrates: Definition and Nomenclature

Carbohydrates include are huge group of natural substances, such as sugars, starch and celluloses. The name can be derived formally from the general formula $C_x(H_2O)_n$.

Depending on the chain length the following is discriminated: trioses ($x = 3$), tetroses ($x = 4$), pentoses ($x = 5$) and hexoses ($x = 6$), also called monosaccharides.

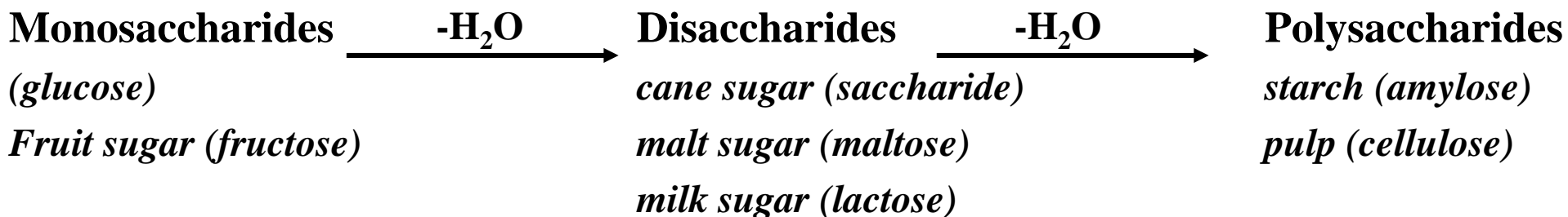

8. Properties of Biomolecules

Carbohydrates: Synthesis and Properties

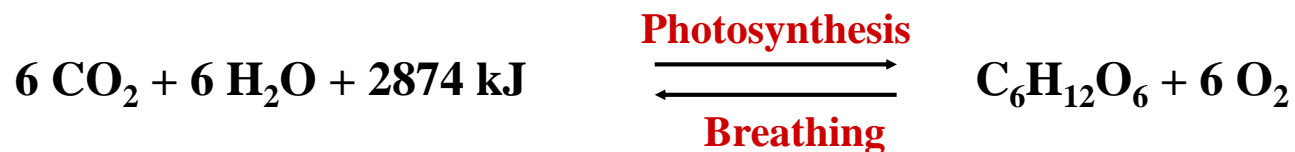

Carbohydrates are polyvalent alcohols, possessing an **aldehyde-** or **keto-**group

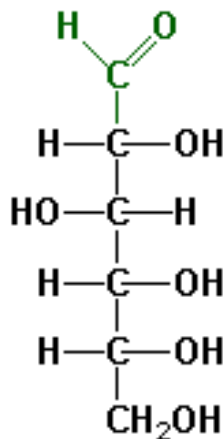

Glucose
(eine **Aldohexose**)

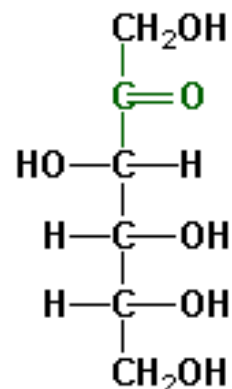

Fructose
(eine **Ketohexose**)

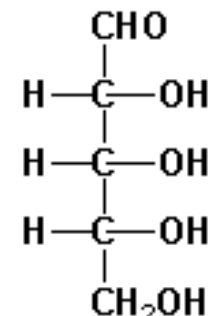

Ribose
(eine **Aldopentose**)

8. Properties of Biomolecules

Carbohydrates:

Aldoses $C_x(H_2O)_n$ with $x = 3 - 6$

Optical properties

- Transparent till ca. 210 nm
- Optically active, i.e. change of phase angle of polarized light
- Exhibit circular-dichroism

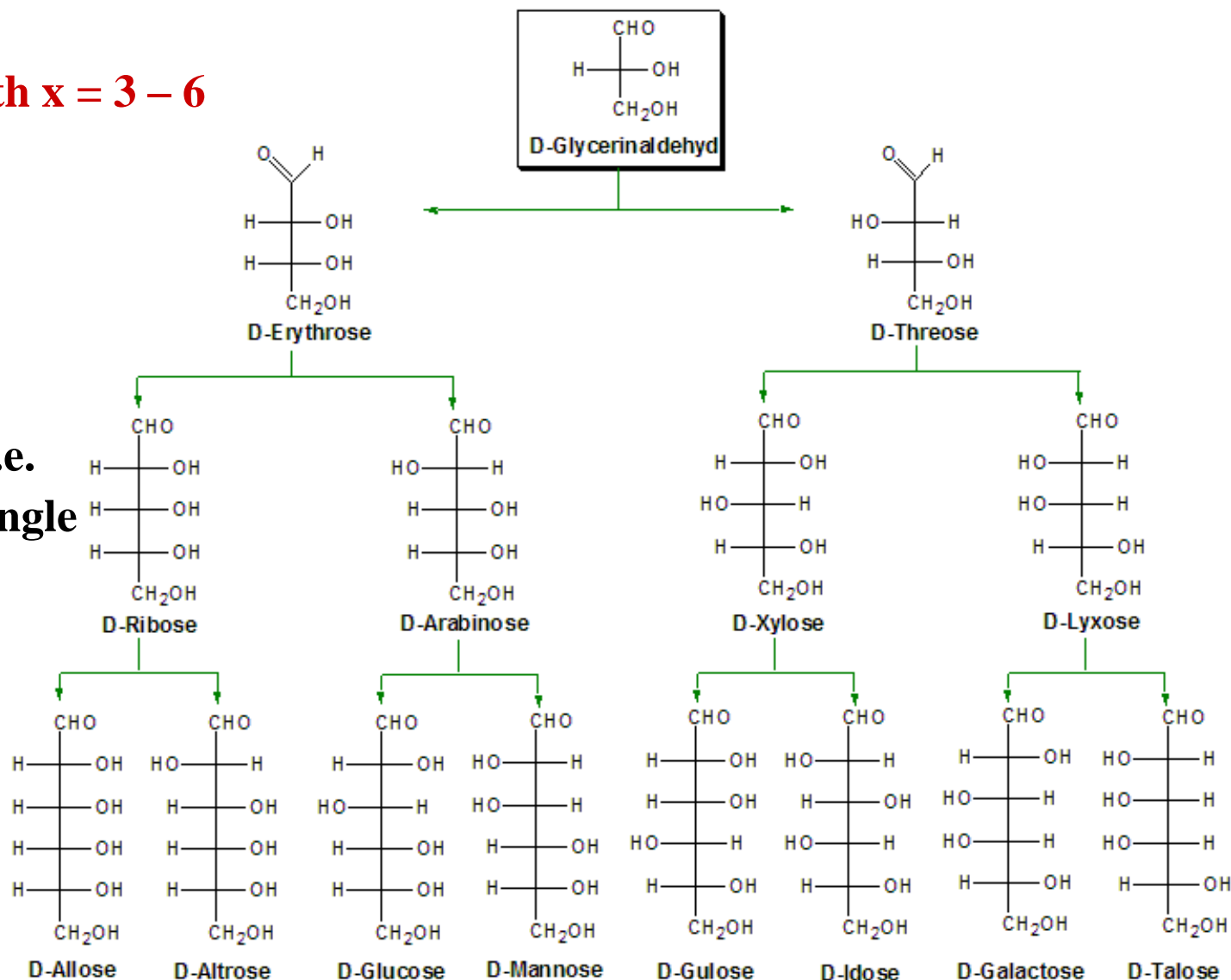

8. Properties of Biomolecules

More Biomolecules: Overview

Class	Example	Function
Lipids	Fat	(Cell)membranes
Phospholipids	Lecithin	(Cell)membranes
Terpenes	Isoprene	Phytonutrients, vitamins, hormone, pigments
Steroids	Sterane	Vitamins, hormones
Heterocycles	Biotin	Vitamins, co-factors
Porphyrins	Heme	Vitamins, pigments, enzymes, transport proteins
Complexes	cis-platinum	Medicine
	[Gd(dota)]	Diagnostics

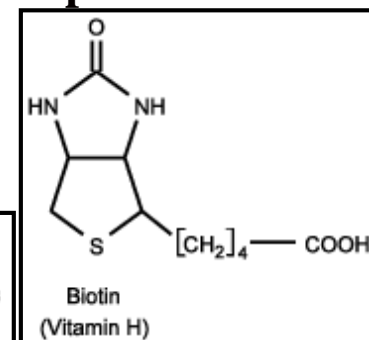
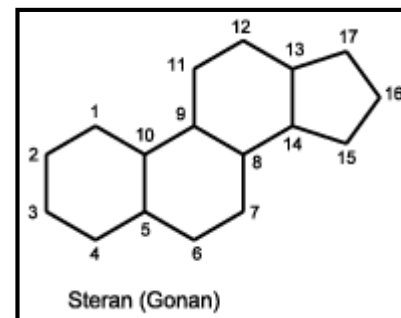
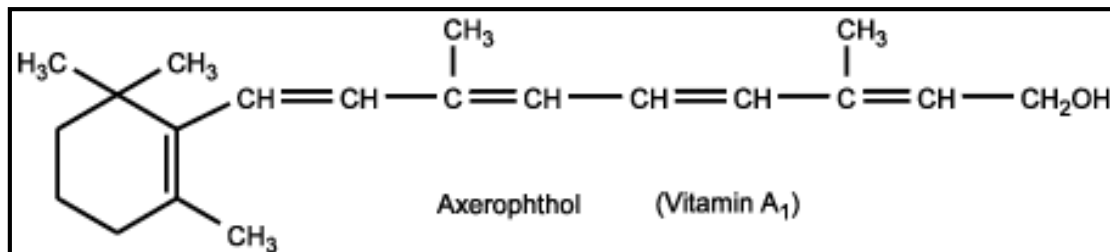

8. Properties of Biomolecules

More Biomolecules: cis-Platinum

Cis-diamine-dichloro-platinum(II) (Peyrone's salt)

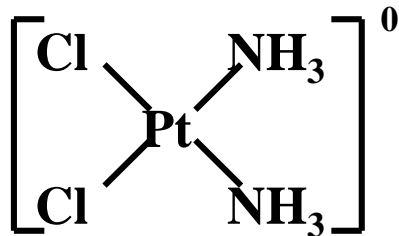

The square-planar cis-platinum disturbs the structure of DNA and leads to the dying of rapidly growing tumour cells

⇒ Chemotherapeutic agent for bronchial carcinoma and tumours in the genitourinary system

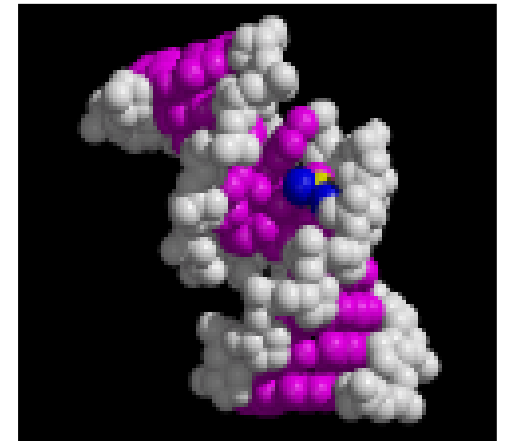

8. Properties of Biomolecules

More Biomolecules: Vitamin D

Formation by photo-
Isomerisation reaction
precalciferol (previtamin D)
+ $h\nu$ (282 nm)
→ calciferol (vitamin D)

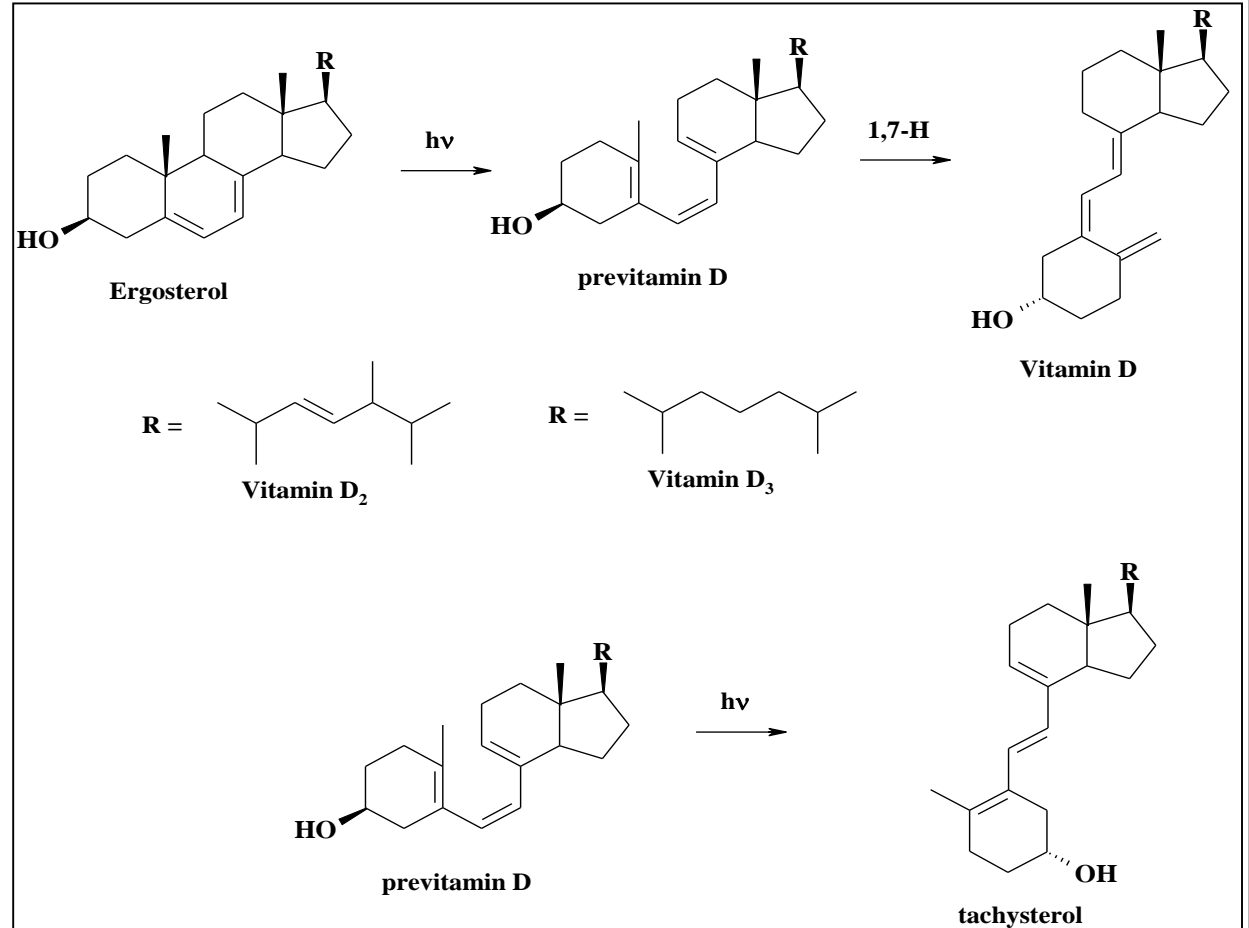
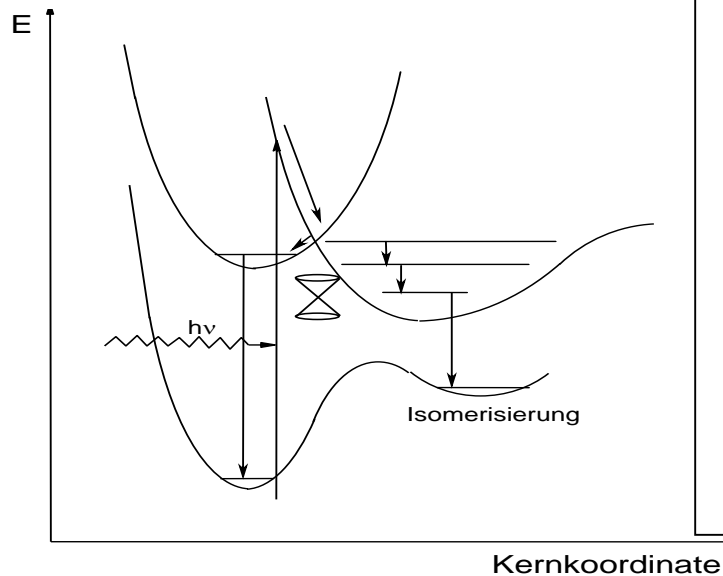

8. Properties of Biomolecules

More Biomolecules: Luciferine (D-LH₂)

Oxidation is catalysed by Luciferase, which is Mg²⁺ dependent

Firefly luciferine is found in Lampyridae species

Benefits

- Attraction
- Communication
- Defence

Application: Luciferine assays for ATP analysis

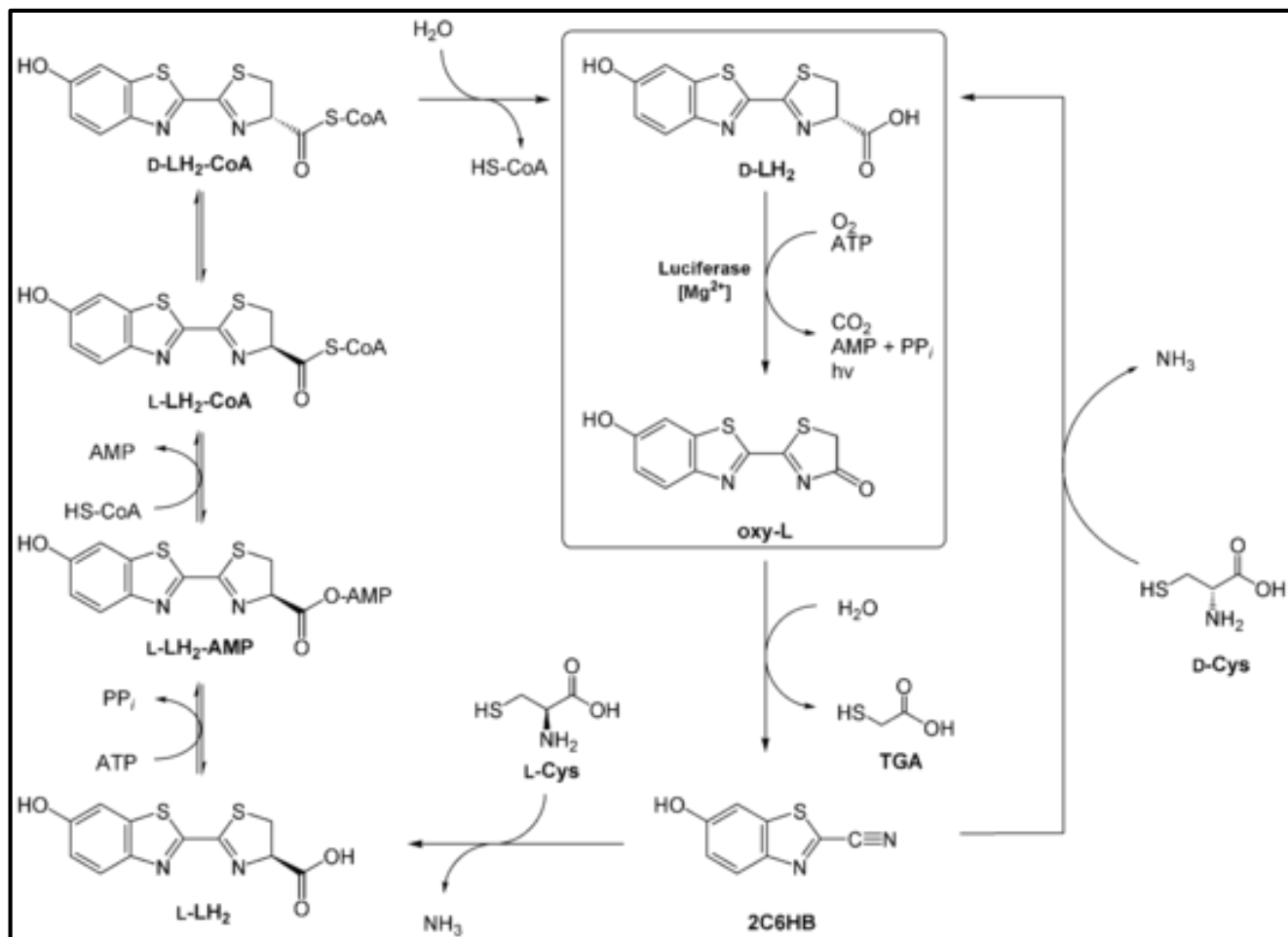

9. Biochemistry of Main Group Elements

The Alkali Metal Cations

Ion	CN	Ionic radius [pm]	Geometry	Ligands	CFSE
Li⁺	4 - 8	73 – 106	variable	0	0
Na⁺	4 – 12	113 – 153	variable	0	0
K⁺	4 – 12	151 – 178	variable	0	0
Rb⁺	6 – 12	166 – 186	variable	0	0
Cs⁺	6 – 12	181 – 202	variable	0	0
Fr⁺	6 – 12	194 (CN = 6)	(radioactive)	0	0

9. Biochemistry of Main Group Elements

The Alkali Metal Cations

Functions

- Osmotic control
- Electrolytic equilibria
- Ionic current
- Control of ionic channels (“gating“)
- Structural stabilisation, e.g. of enzymes like pyruvate kinase

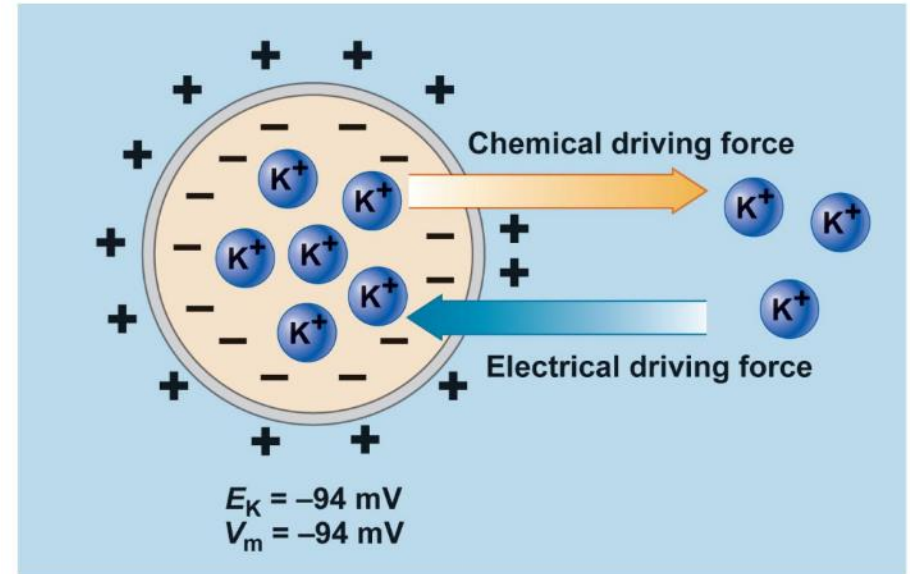

(a)

© 2011 Pearson Education, Inc.

Typical mammal cell: $\sim 100 \text{ mV}$ along 5 nm thick membrane $\Rightarrow 200000 \text{ Vcm}^{-1}$

Ion	Extracellular [mM]	Intracellular [mM]	Membrane-potential [mV]
Na ⁺	150	12	+68
K ⁺	4	140	-99

9. Biochemistry of Main Group Elements

The Alkali Metal Cations

Transportation

a) Ionophors →

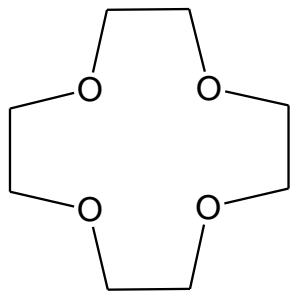

12-crown-4

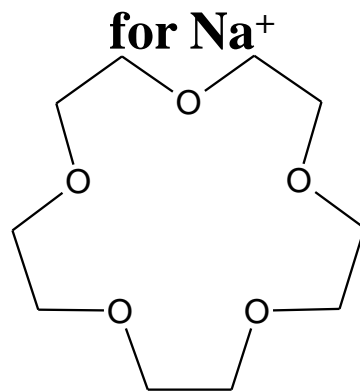

15-crown-5

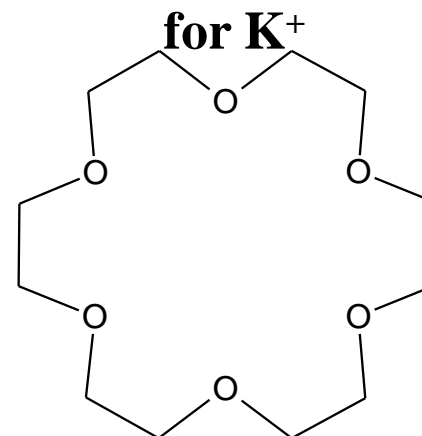

18-crown-6

Monensin A

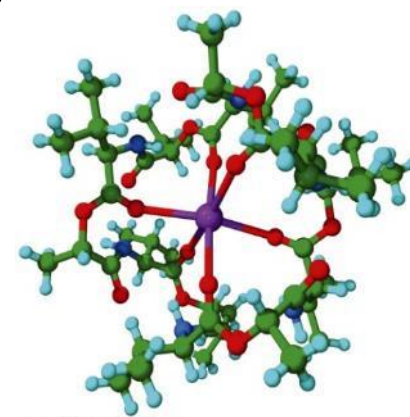
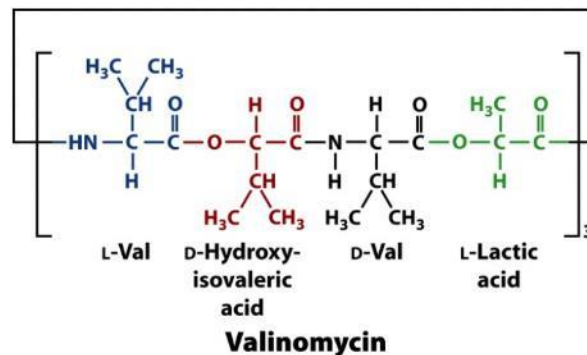
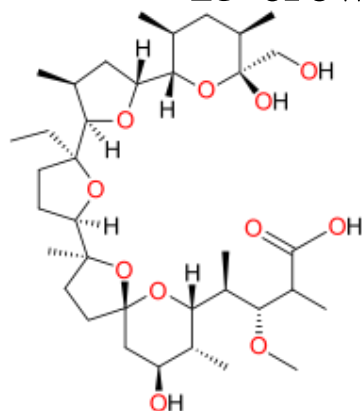

9. Biochemistry of Main Group Elements

The Alkali Metal Cations

Transportation

b) Ion channels

- Integral membrane proteins of high selectivity
- Form pores in membranes, which allow the transportation of ions along electrochemical potentials
- Can be opened or closed, e.g. through neurotransmitters (ligands or Ca^{2+})

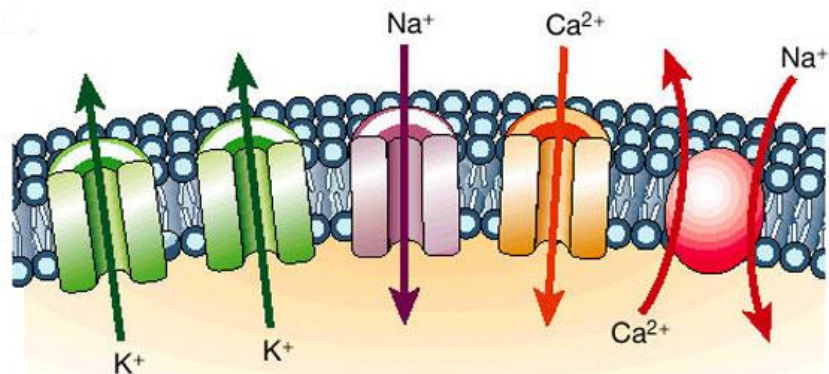

Example: KcsA K^+ ion channel

10000fold selectivity for K^+ vs. Na^+ homotetramer, i.e. four identical protein units

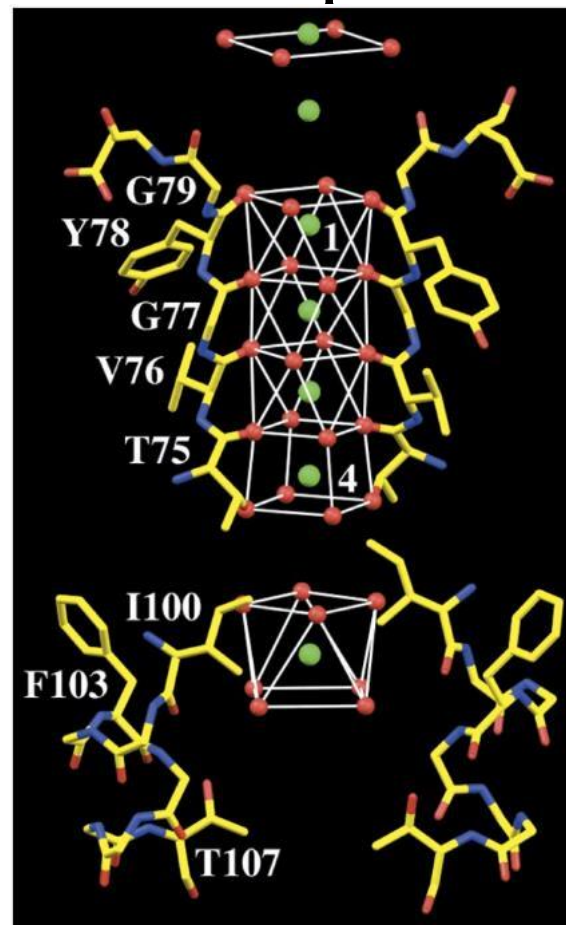

© 2008 John Wiley & Sons, Inc. All rights reserved.

9. Biochemistry of Main Group Elements

The Alkali Metal Cations

Transportation

b) Ion channels

Uniport: $\text{Na}^+ \rightarrow$, Glucose \rightarrow

Symport: $\text{Na}^+/\text{Glucose} \rightarrow$

Antiport: $\text{Na}^+ \rightarrow / \leftarrow \text{K}^+$
 $\text{Na}^+ \rightarrow / \leftarrow \text{Ca}^{2+}$

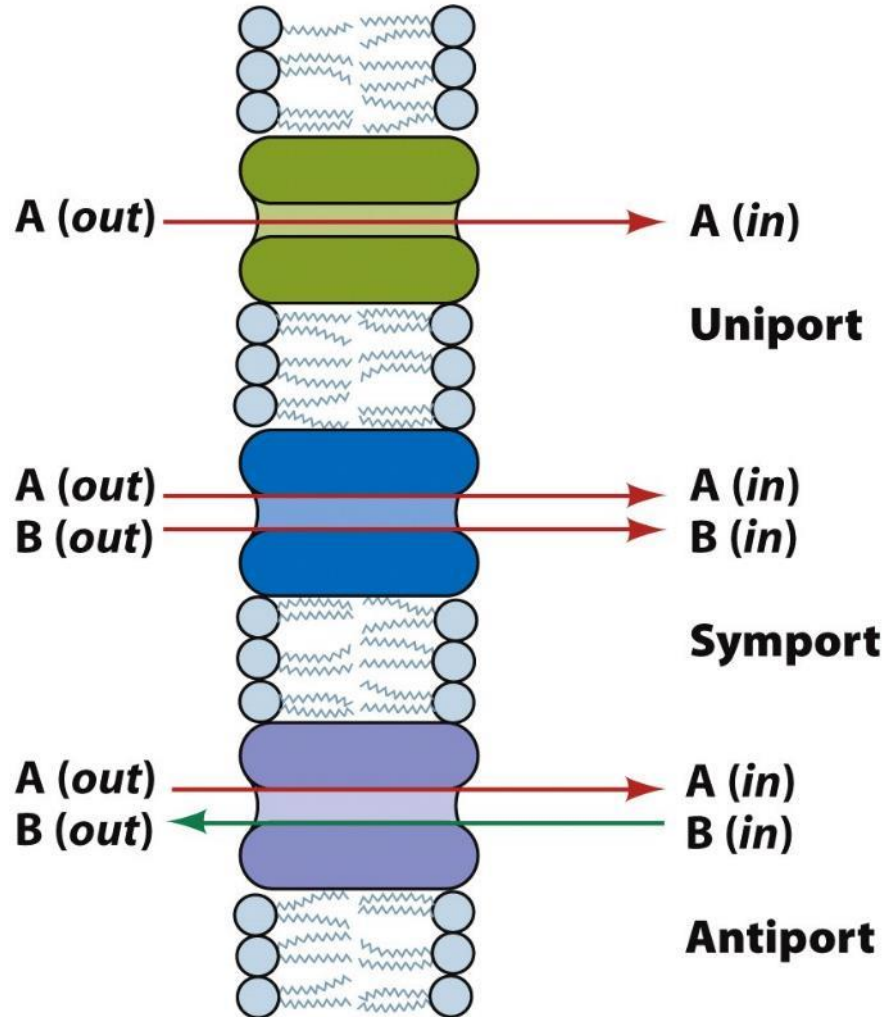

© 2008 John Wiley & Sons, Inc. All rights reserved.

9. Biochemistry of Main Group Elements

The Alkali Metal Cations

Transportation

c) Ion pumps → Na⁺/K⁺-pump (ATPase)

- Maintenance of resting potential
- Regulation of cellular volume
- Signal transduction and integration

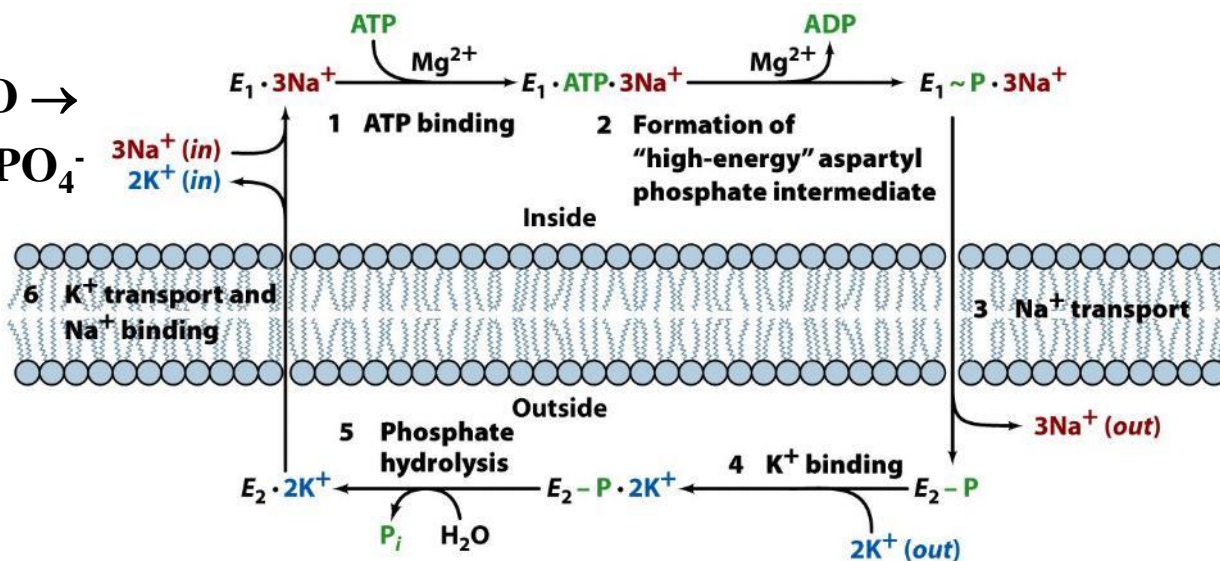
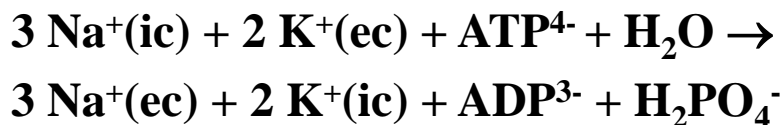

© 2008 John Wiley & Sons, Inc. All rights reserved.

9. Biochemistry of Main Group Elements

The Alkali Metal Cations

Transportation

c) Ion pumps → Na^+/K^+ -pump (ATPase) → uptake of glucose in small intestine

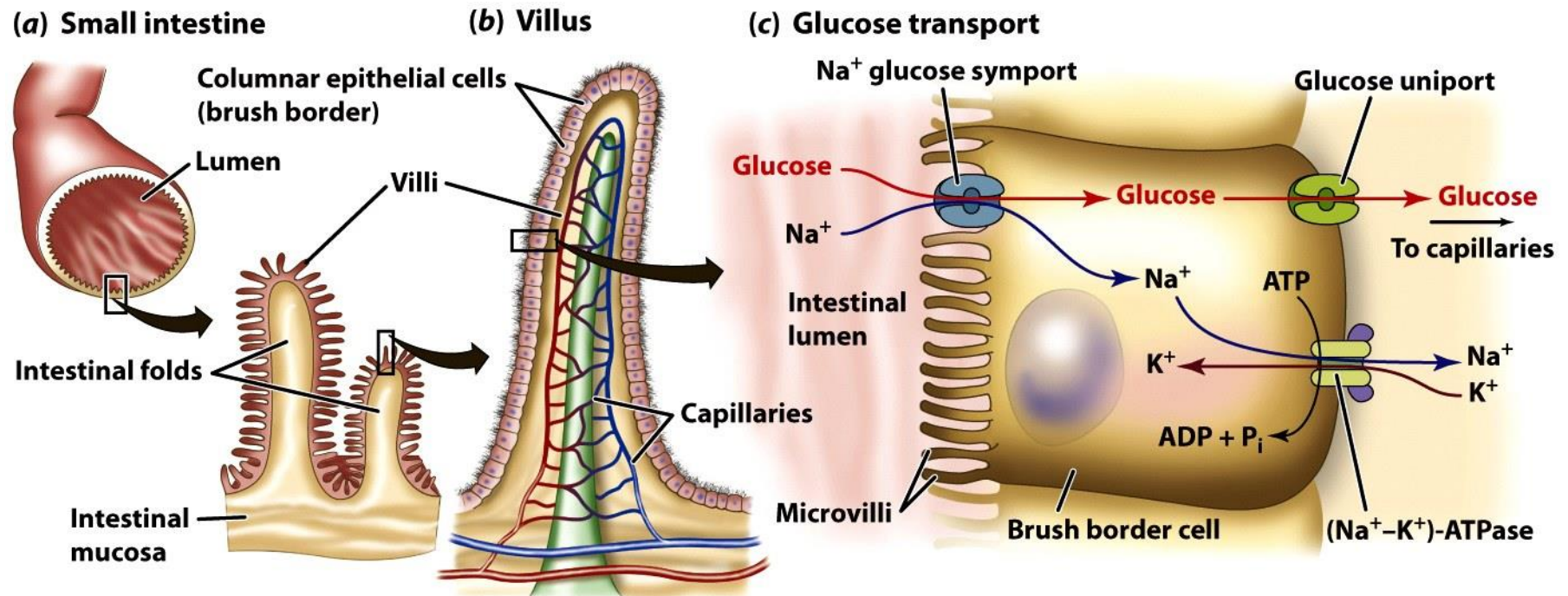

© 2008 John Wiley & Sons, Inc. All rights reserved.

9. Biochemistry of Main Group Elements

The Alkaline Earth Metal Cations

Ion	CN	Ionic radius [pm]	Geometry	Ligands	CFSE
Be²⁺	3 - 6	30 - 59	variable	O	0
Mg²⁺	4 - 8	71 - 103	variable	N, O	0
Ca²⁺	6 - 12	114 - 148	variable	O	0
Sr²⁺	6 - 12	132 - 158	variable	O	0
Ba²⁺	6 - 12	149 - 175	variable	O	0
Ra²⁺	8 - 12	162 - 184	(radioactive)	O	0

9. Biochemistry of Main Group Elements

The Alkaline Earth Metal Cations

Overview of functions

Mg²⁺ **Phosphate metabolism**
Protein-/ nucleic acid structure
Central atom in chlorophyll

Ca²⁺ **Muscle contraction**
Cellular signals
Enzyme activation
Blood coagulation
Mineralisation (endoskeleton)
Morphogenesis
Genetic regulation



**Demineralised bones possess collagen,
wherein the crystals are embedded**

<u>Ion</u>	<u>Extracellular [mM]</u>	<u>Intracellular [mM]</u>
Mg²⁺	1.5	2.5
Ca²⁺	2.5	0.1

9. Biochemistry of Main Group Elements

The Alkaline Earth Metal Cations

Mg^{2+} is very hard and shows high affinity to phosphate $\rightarrow \text{Mg}(\text{NH}_4)\text{PO}_4 / \text{MgKPO}_4$

Functions in detail

- Charge compensation, e.g. for ATP (reduction of negative charge density)
- Polarisation to enhance nucleophilic character: $\text{Mg}^{2+} + \text{H}_2\text{O} \rightarrow [\text{Mg}\cdots\text{OH}]^+ + \text{H}^+$
- Stereo chemical fixation of reactants during phosphate cleavage $\rightarrow \text{ATP/ADP}$
- Catalyst for polyphosphate decomposition?

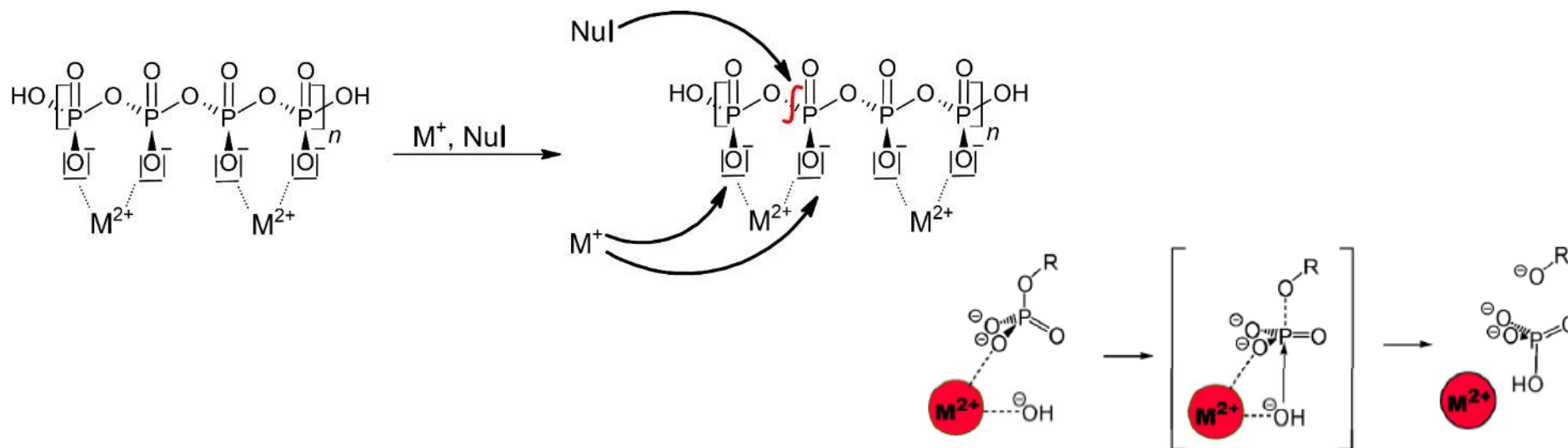

9. Biochemistry of Main Group Elements

The Alkaline Earth Metal Cations

Mg^{2+} controls hydrolysis of ATP

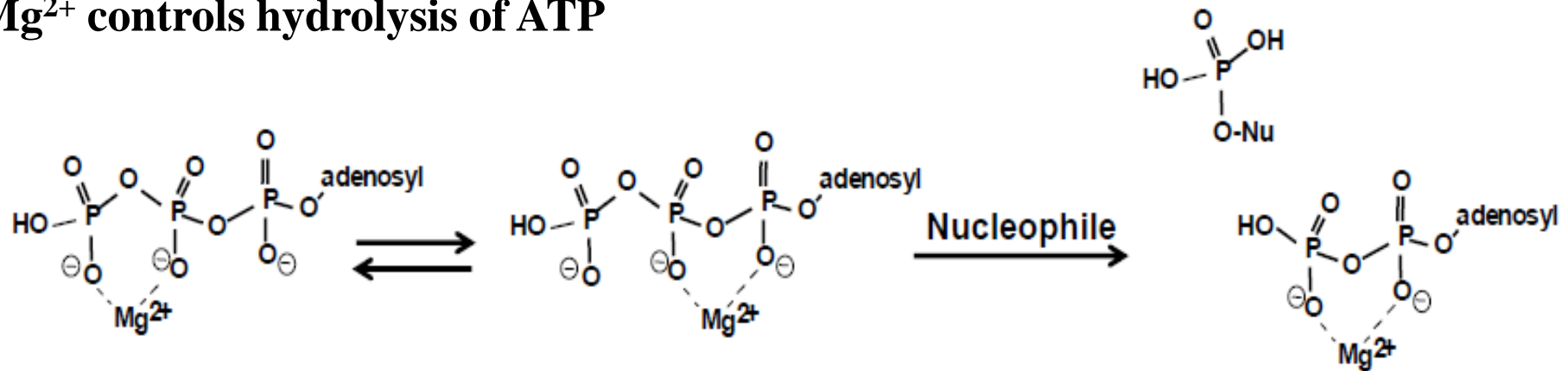

ATP secured

ATP activated for hydrolysis

Phosphate transfer to glyceride \rightarrow 2-phosphoglyceride

Phosphate transfer to creatine \rightarrow creatine phosphate

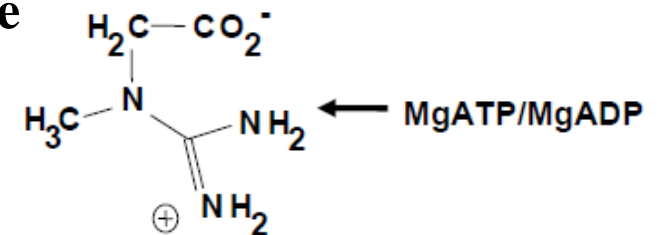

9. Biochemistry of Main Group Elements

The Alkaline Earth Metal Cations

Mg^{2+} is the metal centre complexed by porphyrin ligands in chlorophyll a/b

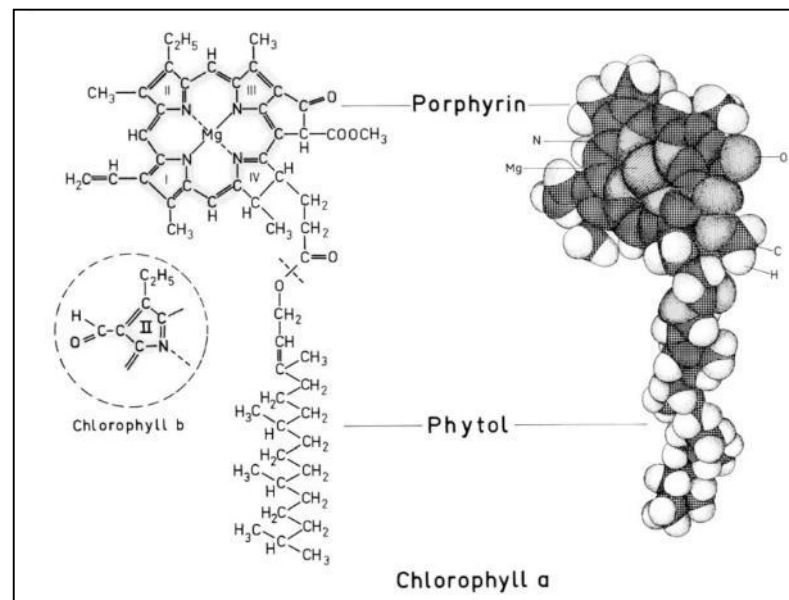
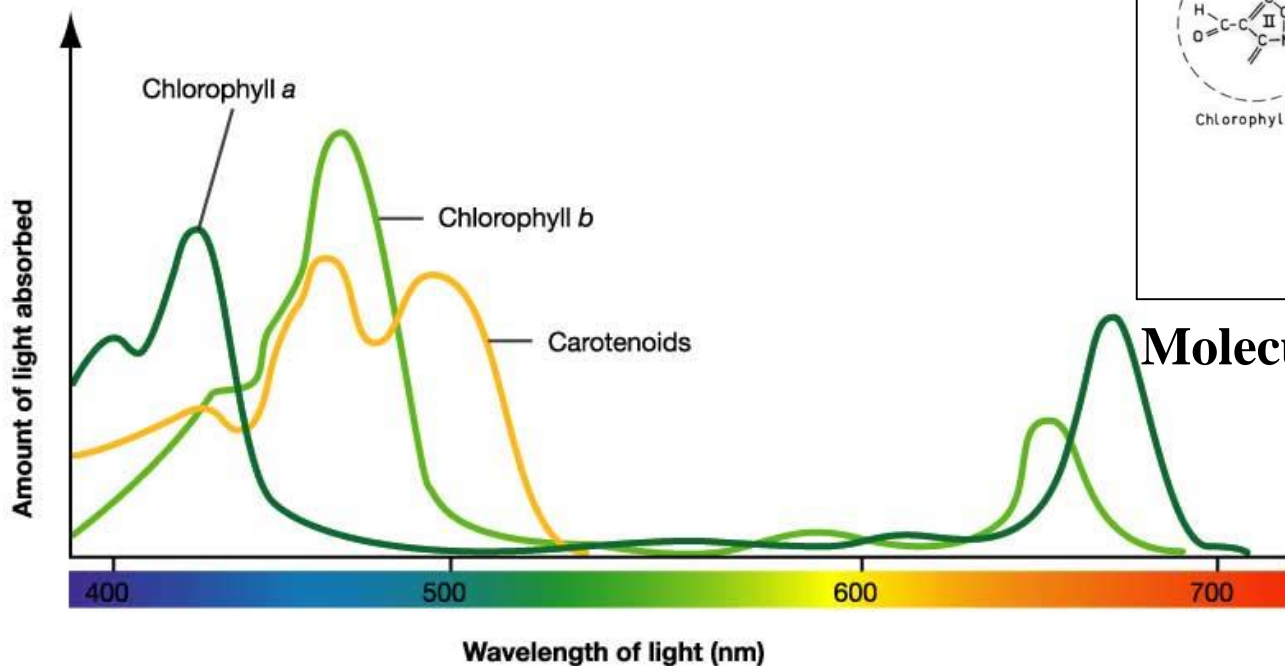

Molecular structure of chlorophyll

Absorption spectrum of the most important pigments in photosynthesis

9. Biochemistry of Main Group Elements

The Alkaline Earth Metal Cations

Fluorescence

Intact leaves

~ 3 - 7%

i.e. ET to
reactive
center

Isolated
chlorophyll

~ 30%

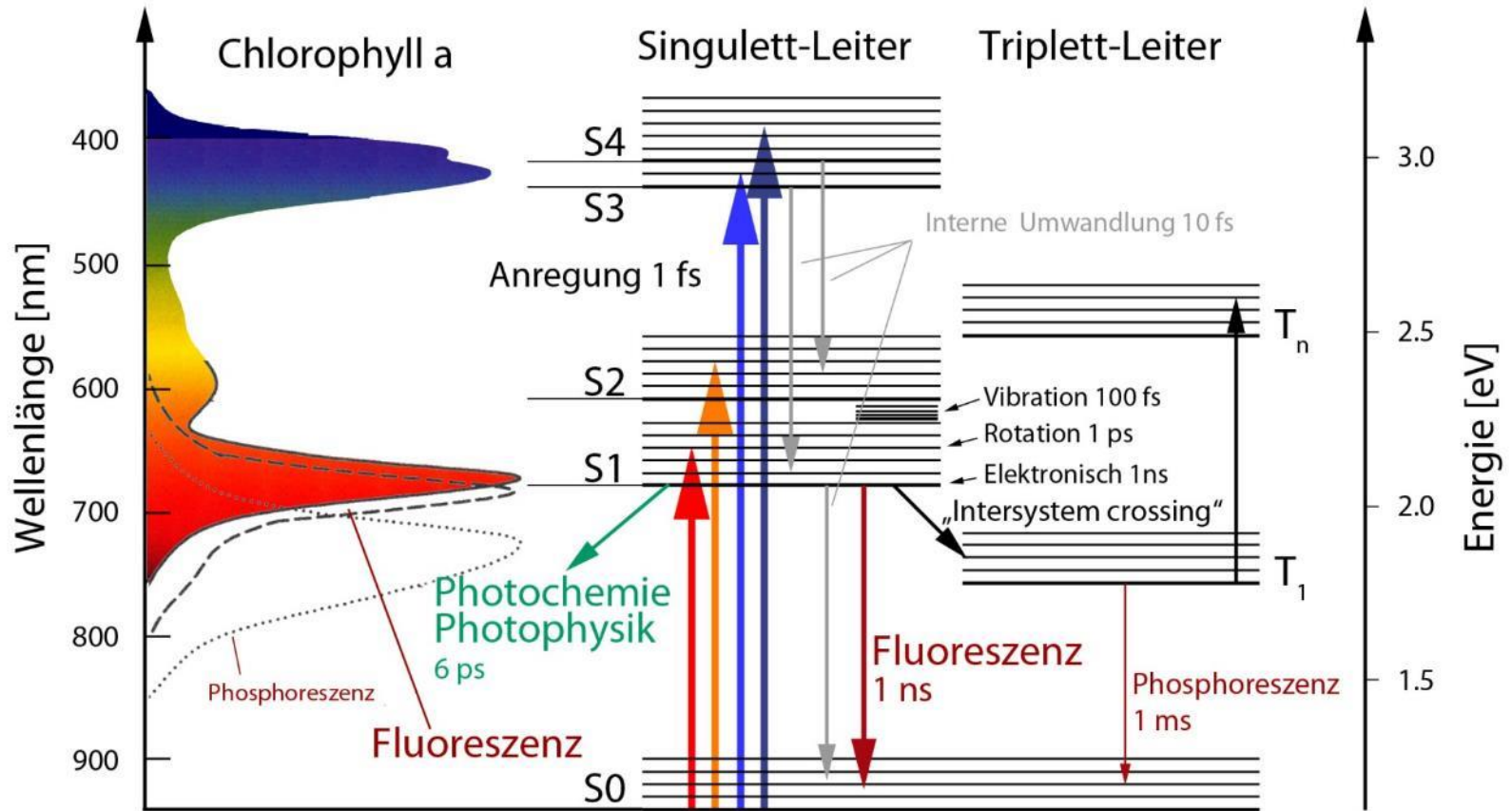

9. Biochemistry of Main Group Elements

The Alkaline Earth Metal Cations

Ca^{2+} exhibits a broad variety of functions

- **Structural functions: protein folding and build-up of skeleton**
 - Exoskeleton
 - Mollusca (mussels, snails)
 - Cnidaria (corals)
 - Arthropods (insects, spiders, scorpions, crayfish...)
 - Endoskeletons
 - Vertebrates (bones and teeth)
 - Cephalopods (cuttlebones)
- **Trigger and activation functions**
 - Bonding to μ_2 -carboxylates of proteins
 - Labile complexes allow fast changes of structure (muscle contraction)
- **Electrolyte transportation**



Cuttlebones of *Sepia officinalis*,
(Source: Wikipedia)

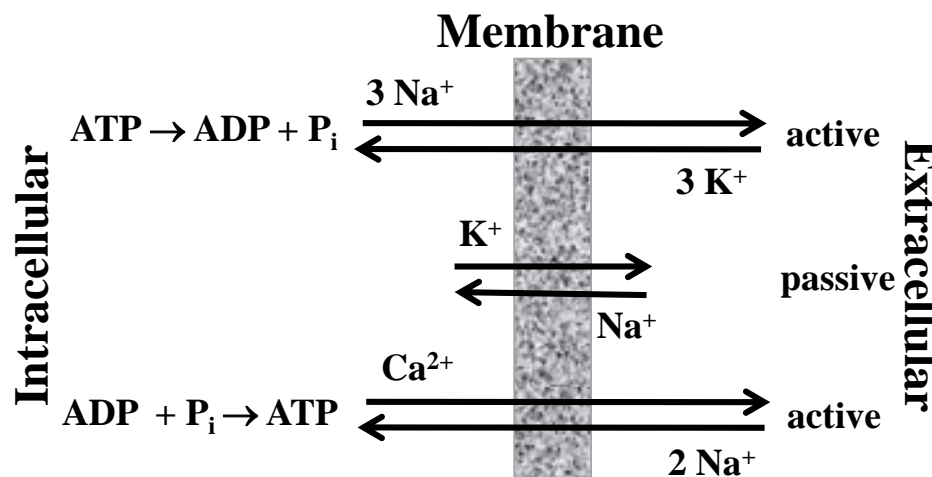

9. Biochemistry of Main Group Elements

The Alkaline Earth Metal Cations

Activation

- Calmodulin = calcium modulating protein
- Conformational changes of apo-Calmodulin upon calcium uptake
- Recognition and activation of enzymes

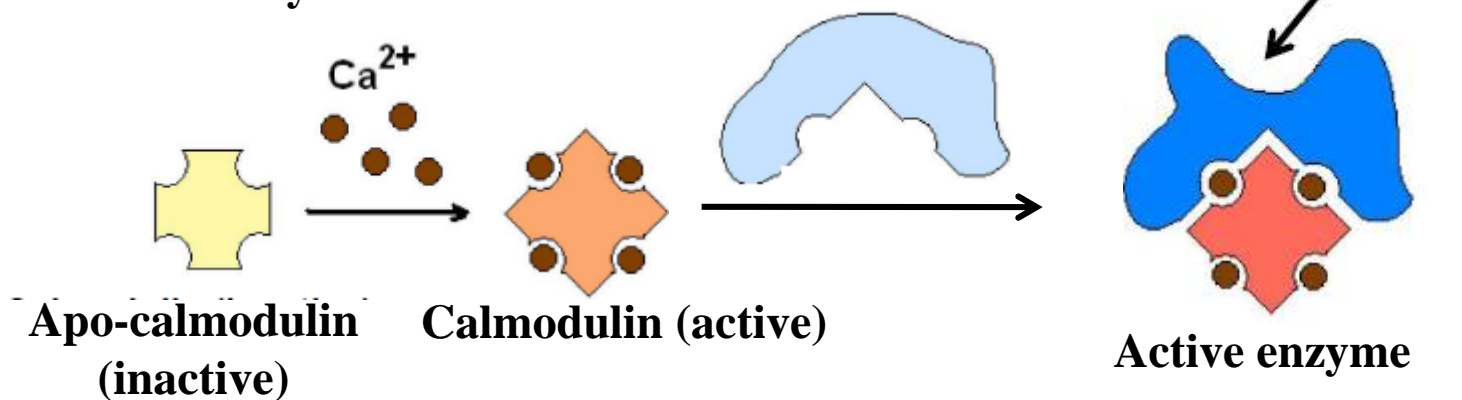

Muscle contraction

- Depolarisation of cell membrane by opening of Na-ion channels
- Liberation of Ca^{2+} from acidic storage protein: calsequestrin
- Calsequestrin contains up to 50 Ca^{2+} -binding sites, i.e. carboxylate groups: Glu, Asp
- Uptake of Ca^{2+} by troponin C, which is coupled with the ATP-hydrolyses

9. Biochemistry of Main Group Elements

The Alkaline Earth Metal Cations

SEM morphologies of CaCO_3 crystals precipitated in the solution, collagen concentration: 0.1 g/l. (a) Irregular rhombohedral calcite crystal grown in the solution without magnesium. (b) Irregular lumpish crystals with lamellar growth structure (Mg/Ca:1). (c, d, e) Discoid and dumbbell calcium carbonate crystals. (f) Spherical aragonite crystals at higher Mg^{2+} concentration (Mg/Ca:5). (g) Spherical aragonite crystals with more regular shape (Mg/Ca:5, collagen concentration:0.4 g/l). (h) Aragonite crystals with needlelike shape without collagen (Mg/Ca:5) (Lit.: Jiao et al. 2006)

Biom mineralisation (CaCO_3)

- In mussels, snails, otoliths, ...
- Morphological control and orientation by organic ligands
 - Carboxyl groups (glu, asp, ...)
 - Oxidised carbohydrates
 - Collagene
- Lab examples
 - Spindle-shaped calcite crystals in presence of malonic acid
 - Disc-shaped vaterite crystals through stearic acid

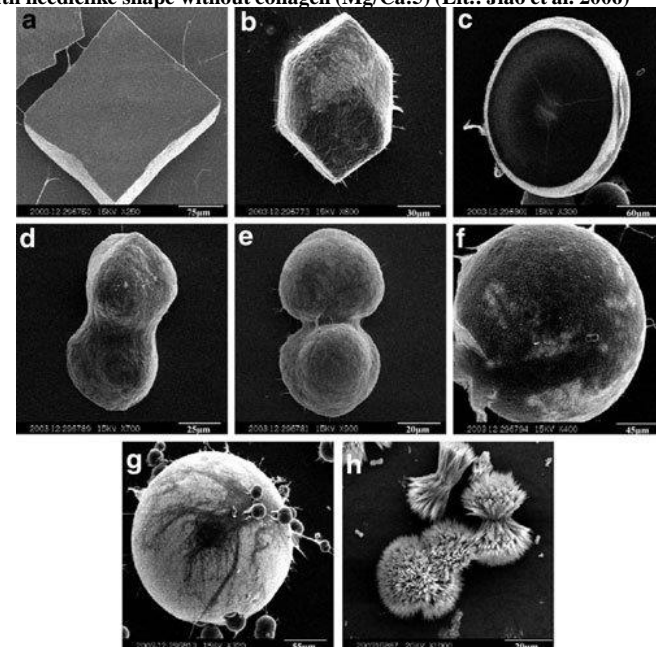

Modification	CaCO_3 (aragonite)	CaCO_3 (calcite)	CaCO_3 (vaterite)
Crystal system	Orthorhombic	Trigonal	Hexagonal
Space group	Pnma (#62)	R-3ch (#167)	P63/mmc (#194)
Coordination number	9	6	8
Formula unit/unit cell	4	6	2

9. Biochemistry of Main Group Elements

The Alkaline Earth Metal Cations

Biom mineralisation of CaCO_3

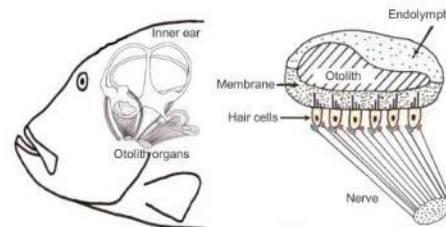

Aragonite (meta-stable)

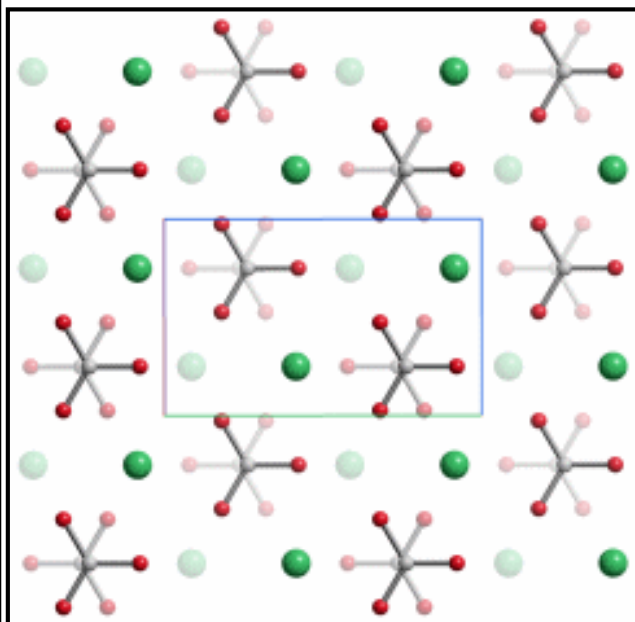

Fish-otoliths, corals, pearls

Calcite (stable)

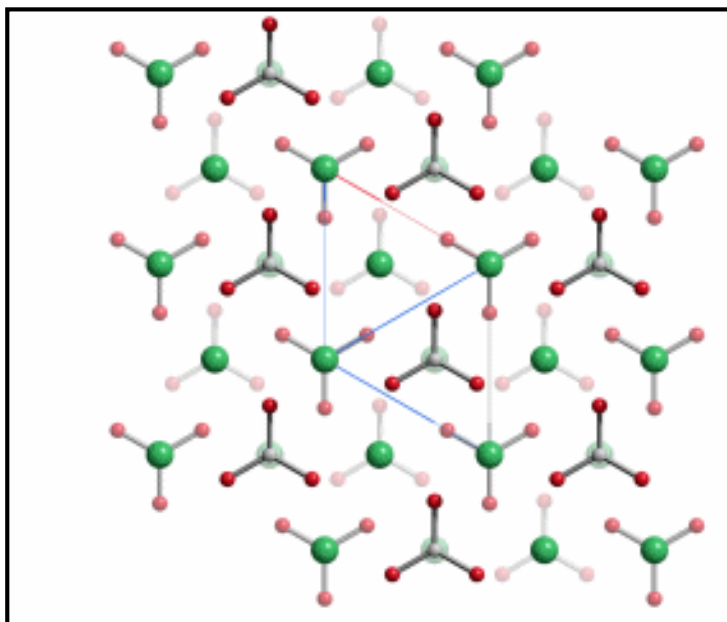

Mussel shells

Vaterite (meta-stable)

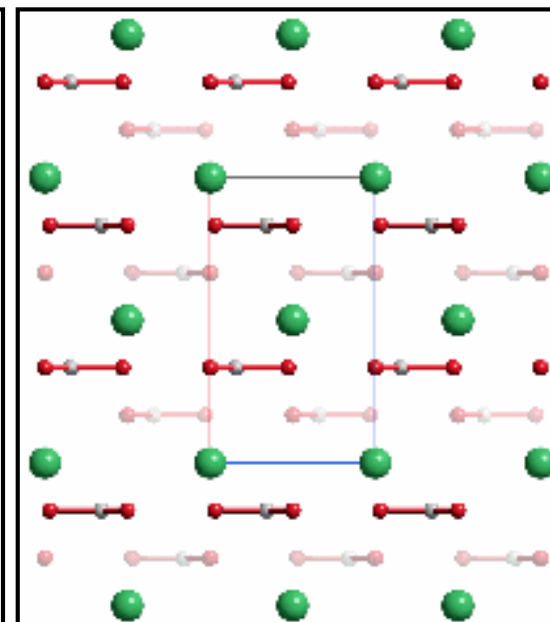

Spheruliths

9. Biochemistry of Main Group Elements

The Alkaline Earth Metal Cations

Biom mineralisation of $\text{Ca}_5[\text{PO}_4]_3\text{X}$ with $\text{X} = \text{OH}$

- In bones of vertebra and cephalopods
- Collagen serves as template, i.e. it defines the orientation of the apatite crystals
- Binding of Ca^{2+} via carboxylates groups of osteocalcin and via phosphoproteins

Hydroxyapatite $\text{Ca}_5[\text{PO}_4]_3\text{OH}$

Crystal system	Trigonal
Space group	Pnma (#176)
Coordination number	8 and 9
Formula unit per unit cell	2

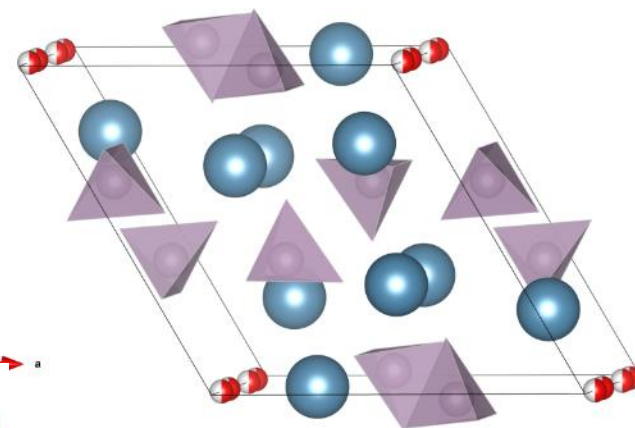
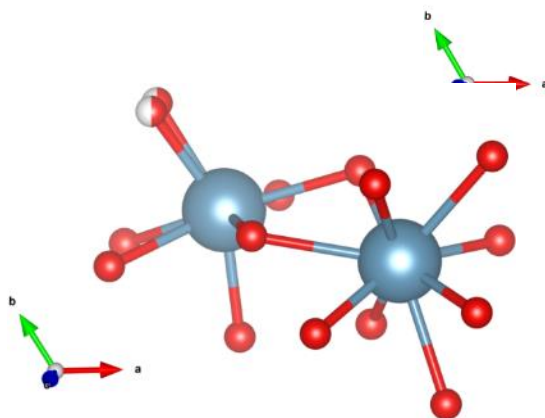

9. Biochemistry of Main Group Elements

The Alkaline Earth Metal Cations

Biom mineralisation of $\text{Ca}_5[\text{PO}_4]_3\text{X}$ with $\text{X} = \text{F}$

- In teeth (enamel) of vertebrates and cephalopods
- Is formed by fluorination of hydroxyapatite (toothpaste contains $\text{Na}_2\text{PO}_3\text{F}$)

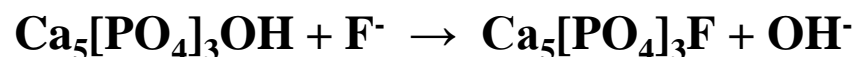

Fluoroapatite $\text{Ca}_5[\text{PO}_4]_3\text{F}$

Crystal system	Trigonal
Space group	Pnma (#176)
Coordination number	7 and 9
Formula unit per unit cell	2

Pyrophosphates $\alpha\text{-Ca}_2\text{P}_2\text{O}_7$ and $\beta\text{-Ca}_2\text{P}_2\text{O}_7$

- Crystal-induced arthropathy

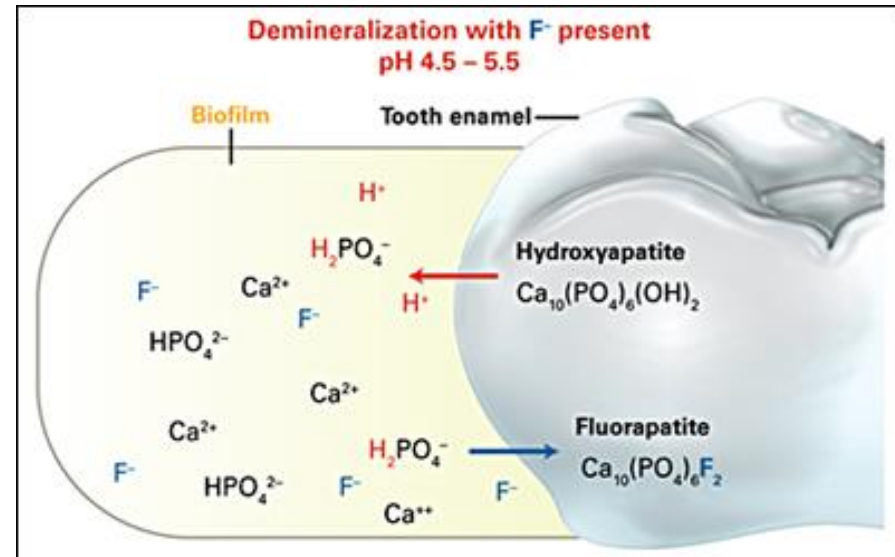

9. Biochemistry of Main Group Elements

The Alkaline Earth Metal Cations

Osteocalcin

- **Fixates apatite**

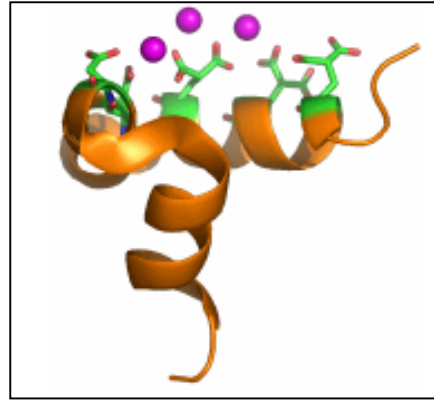

Collagen

- **Three left-handed helices, combined to a right-handed super-helix**
- **Composite material without binding sites for Ca^{2+}**
- **Apatite crystals are incorporated parallel to the collagen helix**

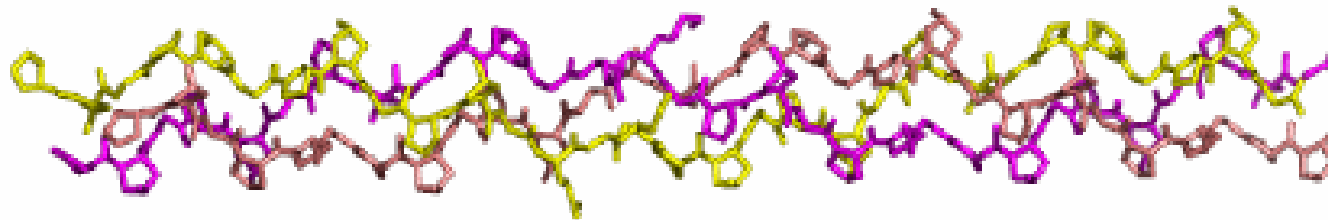
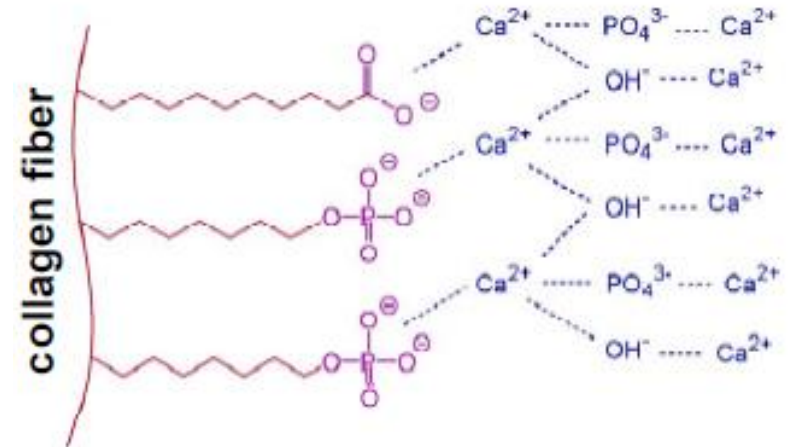

9. Biochemistry of Main Group Elements

The Alkaline Earth Metal Cations

Calciumpyrophosphates

Formula	$\text{Ca}_2\text{P}_2\text{O}_7 \cdot 2\text{H}_2\text{O}$ (CPPD)	$\text{Ca}_2\text{P}_2\text{O}_7 \cdot \text{H}_2\text{O}$
Crystal system	triclinic	monoclinic
Space group	P1	$\text{P}2_1/\text{n}$
Z	2	4
CN		7 (Ca1), 6 (Ca2)

Causes “Crowned Dens Syndrome”: Severe neck pain

Literature

- Acta Cryst. B31 (1975) 1730
- J. Bone Joint Surg. Am. 89 (2007) 2732
- Acta Cryst. C70 (2014) 862

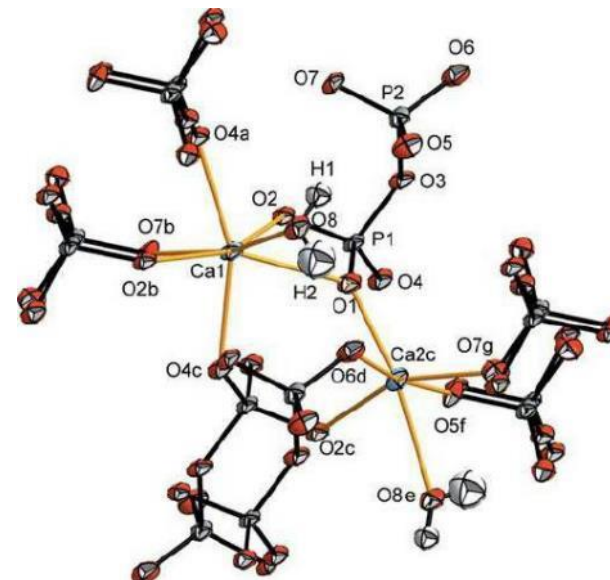

10. Biochemistry of Transition Metals

Titanium Group

Titanium



Ti^{4+} [Ar] **TiO₂ is poorly soluble and non-toxic even if orally ingested**
[Ti(cp)₂Cl₂] (titanocendichloride) and cis,cis,cis- Δ -[Ti(bzac)₂(OEt₂)] (budotitanium) are used as cancerostatica (with bzac = 1-phenylbutane-1,3-dion)

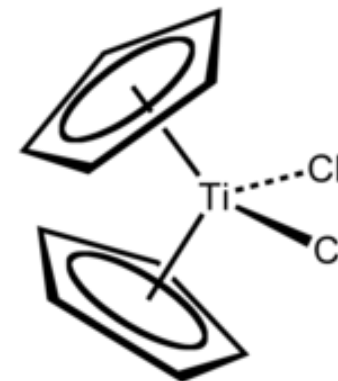

Zirconium

Zr^{4+} [Kr] **ZrO₂, ZrSiO₄ and zirconate (MZrO₃) are poorly soluble**

Hafnium

Hf^{4+} [Xe] **Hafnium is scarce in the earth's crust and HfO₂ is also poorly soluble, which is why hafnium is of no importance for the biosphere**

10. Biochemistry of Transition Metals

The Vanadium Group

Vanadium



violet



green



blue



colourless to pale yellow



Niobium



Nb_2O_5 and niobates
($MNbO_4$) are poorly soluble

Tantalum



metallic tantalum is high-melting and chemically inert
permanent implants such as bone nails, springs or plates



Ta_2O_5 and niobate ($MNbO_4$) are poorly soluble

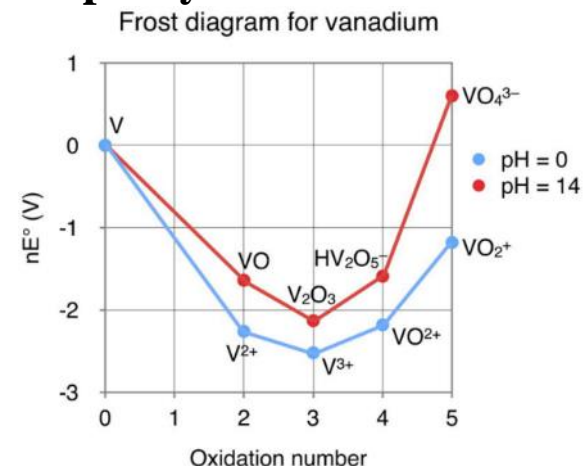

10. Biochemistry of Transition Metals

The Vanadium Group

Enrichment

- **Amavadin**
In fly agarics (*amanita muscaria*), V^{4+}
is accumulated in the bottom of the toadstool
- **Storage protein vanabin is responsible for the enrichment of VO^{2+} in vanadocytes of sea squirts (*ascidia gemmata*)**
→ accumulation

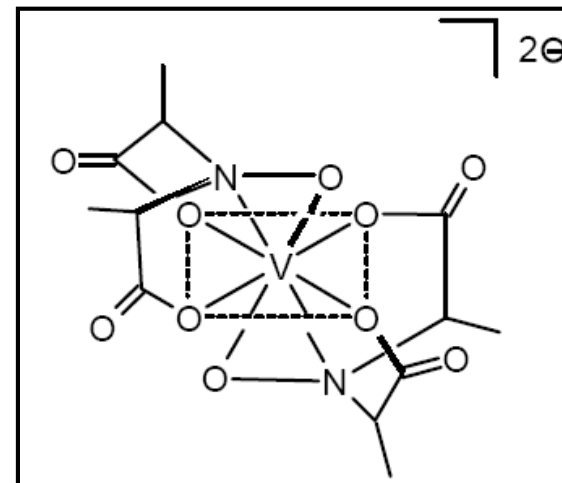

10. Biochemistry of Transition Metals

The Vanadium Group

Oxygen control?

- Tunicates comprise vanadocytes, in which V^{3+} is enriched for oxygen storage/transport?
Today: $\sim 35 \text{ nmol/l VO}_4^{3-}$ in seawater

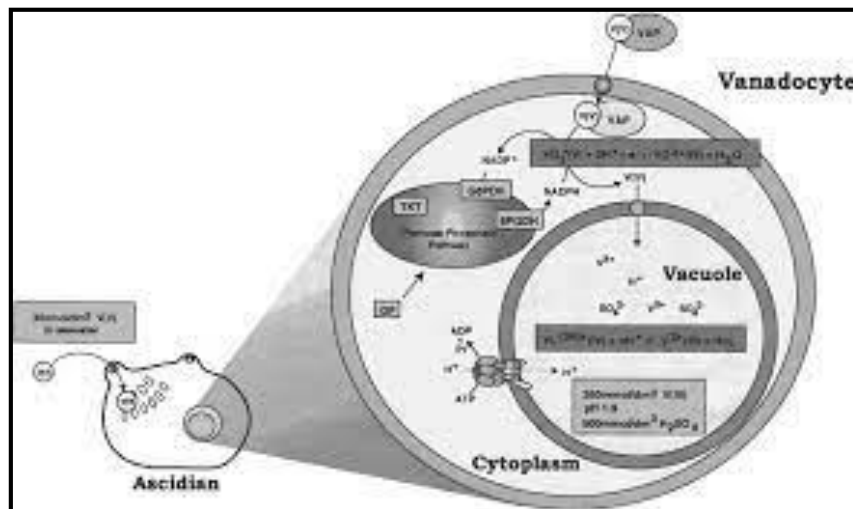

- Insulin mimetics
 $VOSO_4$
 $[VO(acac)_2]$
Bis(maltolato)oxovanadium

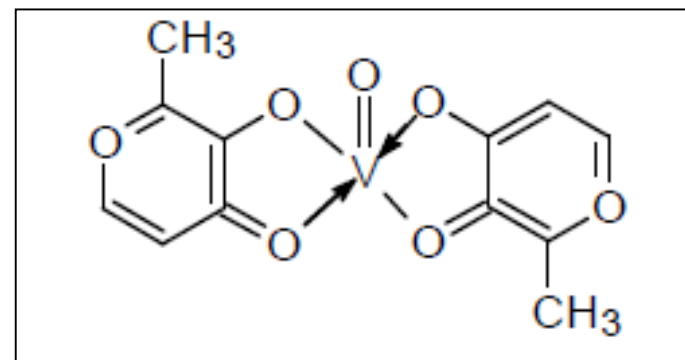

10. Biochemistry of Transition Metals

The Vanadium Group

Metal enzymes

- Haloperoxidases (e.g. in knotted wrack, *ascophyllum nodosum*) contain in their activated form vanadin(V)-ions in trigonal-bipyramidal coordination

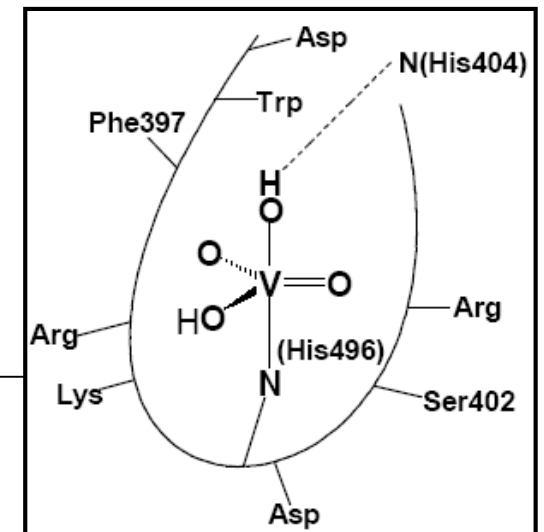
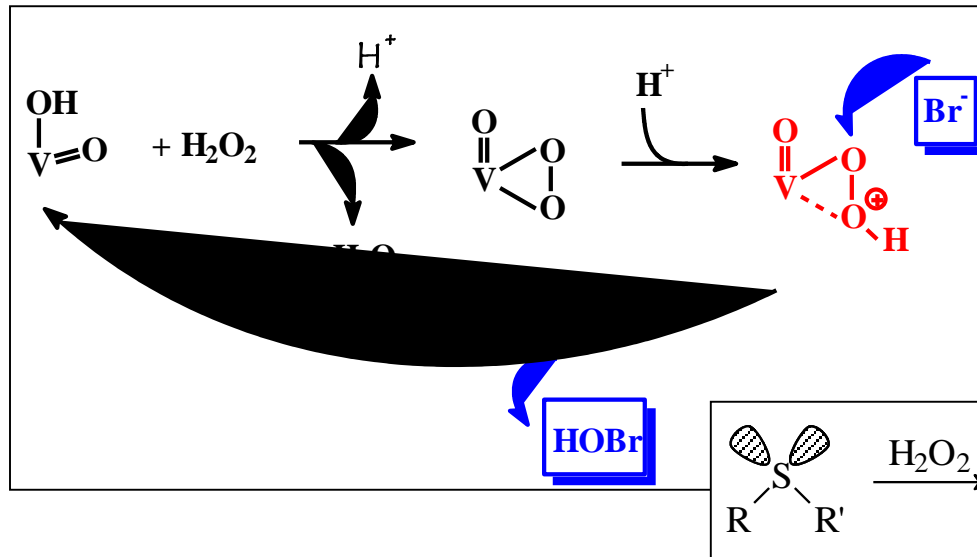
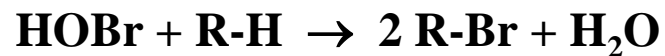
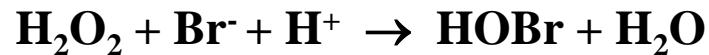

10. Biochemistry of Transition Metals

The Vanadium Group

Metal enzymes

- **Nitrogenases**

e.g. from *azotobacter chroococcum* and *azotobacter vinelandii*

some mutants contain Fe-V-cluster

Mo can be replaced by V

→ diagonal relationship V/Mo

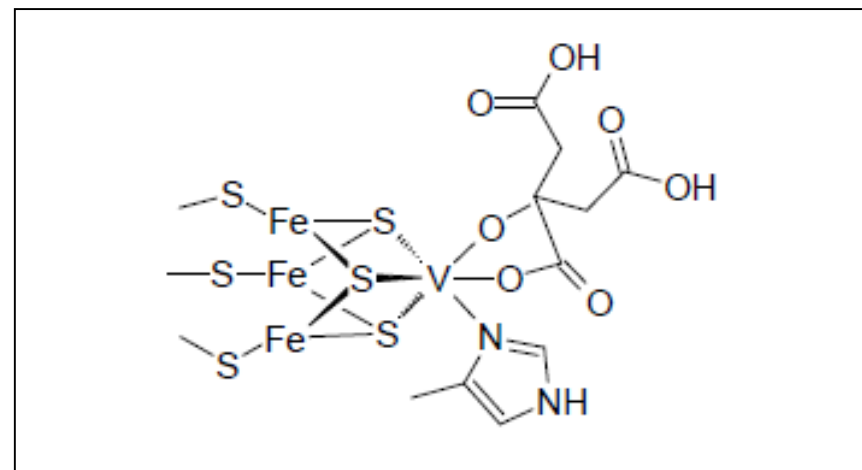

- **Model complexes for fixation of nitrogen**

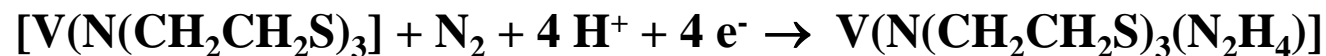

10. Biochemistry of Transition Metals

The Chromium Group

Chromium

Cr^{2+}	$[\text{Ar}]3d^4$	$[\text{Cr}(\text{H}_2\text{O})_6]^{2+}$	
Cr^{3+}	$[\text{Ar}]3d^3$	$[\text{Cr}(\text{H}_2\text{O})_6]^{3+}$	
Cr^{4+}	$[\text{Ar}]3d^2$	$[\text{CrO}(\text{H}_2\text{O})_4]^{2+}$	
Cr^{5+}	$[\text{Ar}]3d^1$	CrO_4^{3-}	
Cr^{6+}	$[\text{Ar}]$	$\text{CrO}_3, \text{CrO}_4^{2-}, \text{Cr}_2\text{O}_7^{2-}$	toxic and carcinogenic

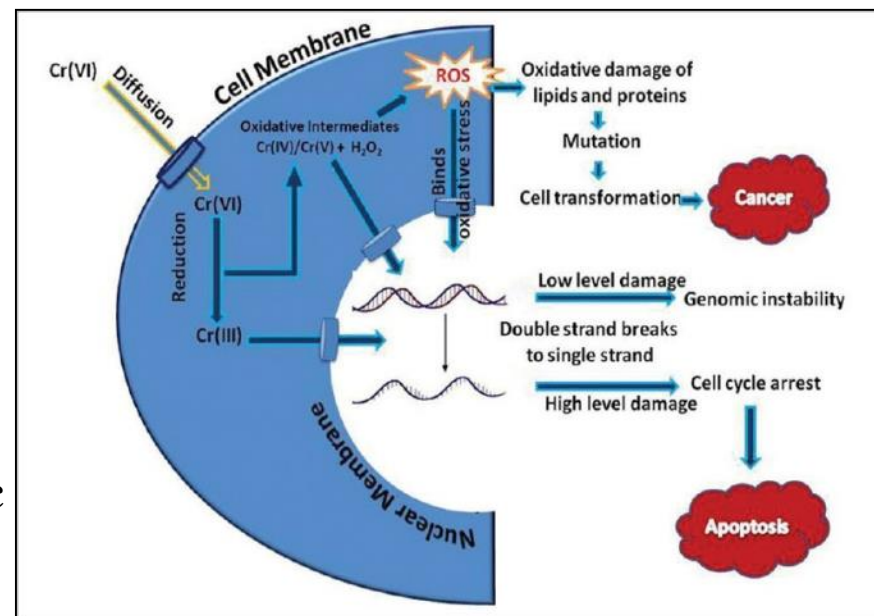

Molybdenum

Mo^{4+}	$[\text{Kr}]4d^2$	involved in 2-electron reductions (nitrate reductases)
Mo^{6+}	$[\text{Kr}]$	MoO_4^{2-} and $\text{Mo}_7\text{O}_{24}^{6-}$

Tungsten

W^{4+}	$[\text{Xe}]5d^2$	WO_4^{4-}	
W^{5+}	$[\text{Xe}]5d^1$	WO_4^{3-}	tungsten blue
W^{6+}	$[\text{Xe}]$	WO_4^{2-}	tungstates are poorly soluble

10. Biochemistry of Transition Metals

The Chromium Group

Chromium

- Chromium(VI) is carcinogenic, because it can oxidize the OH-groups of deoxyribose of DNA and also proteins

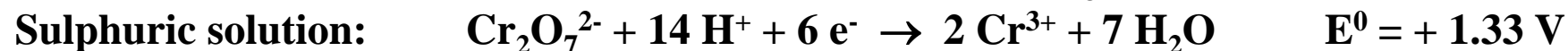
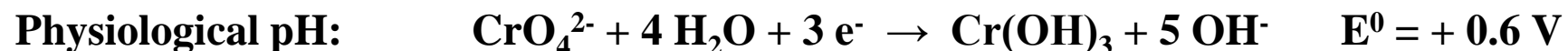

- Chromium(III) regulates the blood sugar level glucose-tolerance factor together with insulin and glucagon
- Cr^{3+} is transported by transferrin (Fe-transporter)
- Chromium deprivation may foster high blood pressure

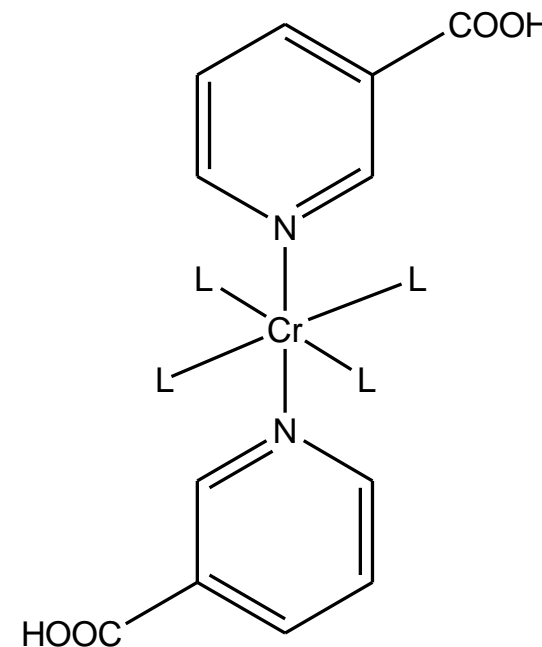

10. Biochemistry of Transition Metals

The Chromium Group

Molybdenum

- Only element of 2nd transition metal series of biological importance
- As molybdate MoO_4^{2-} readily soluble and available through sea water
- Forms polyoxymolybdates $\rightarrow \text{Mo}_7\text{O}_{24}^{6-}$, $\text{Mo}_8\text{O}_{26}^{4-}$, $\text{Mo}_{36}\text{O}_{112}^{8-}$, and so on
- Biochemically relevant oxidation states: IV, V, VI
 \Rightarrow 1- or 2-electron-transfer-reactions
- Take part in nitrogen fixation
- Coordination by O-, S- and N-ligands
- Relevant enzymes
 - Nitrogenases
 - Nitrate reductases
 - Aldehyde oxidases
 - Oxytransferases

Azotobacter



Sources:
Wikipedia

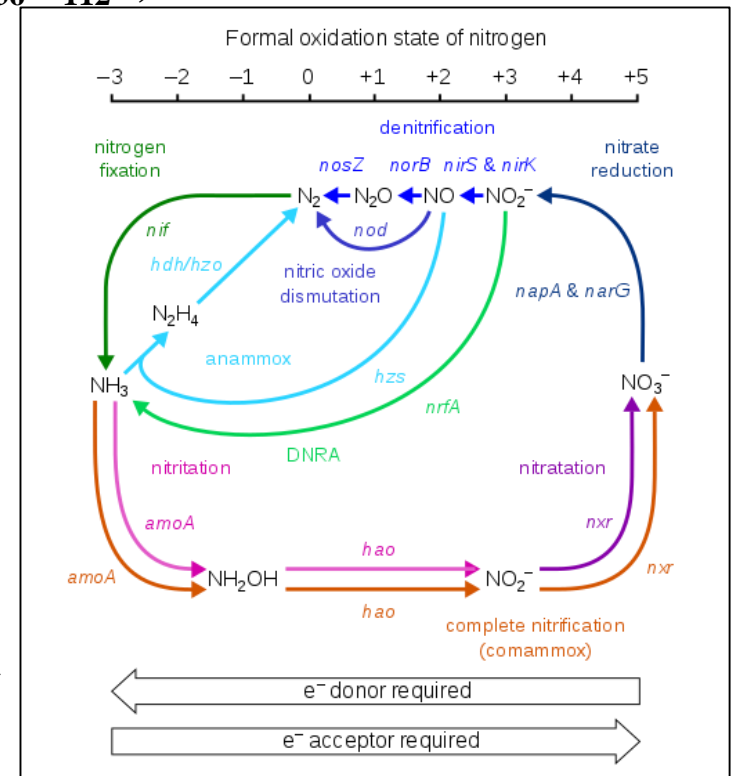

10. Biochemistry of Transition Metals

The Chromium Group

Nitrogen fixation by nitrogenases

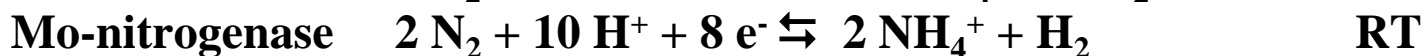
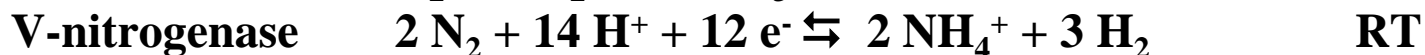

 -Cluster

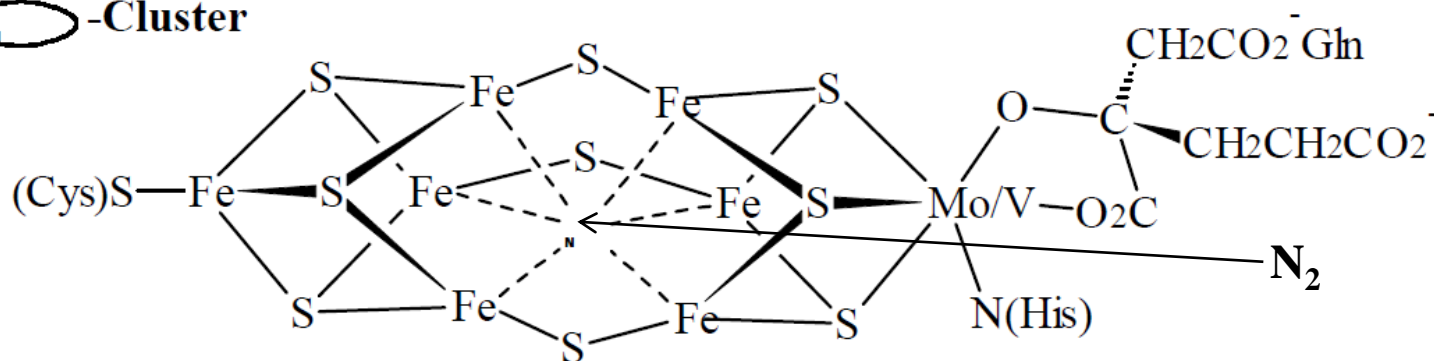

Structural models to elucidate the function

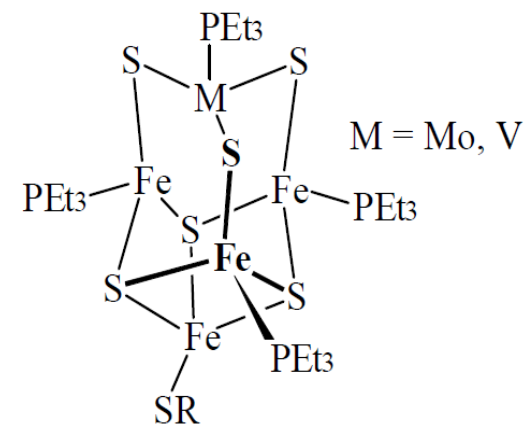
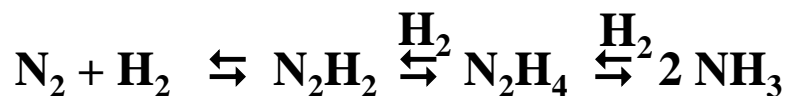

10. Biochemistry of Transition Metals

The Chromium Group

Oxytransferases with molybdenum (molybdopterin)

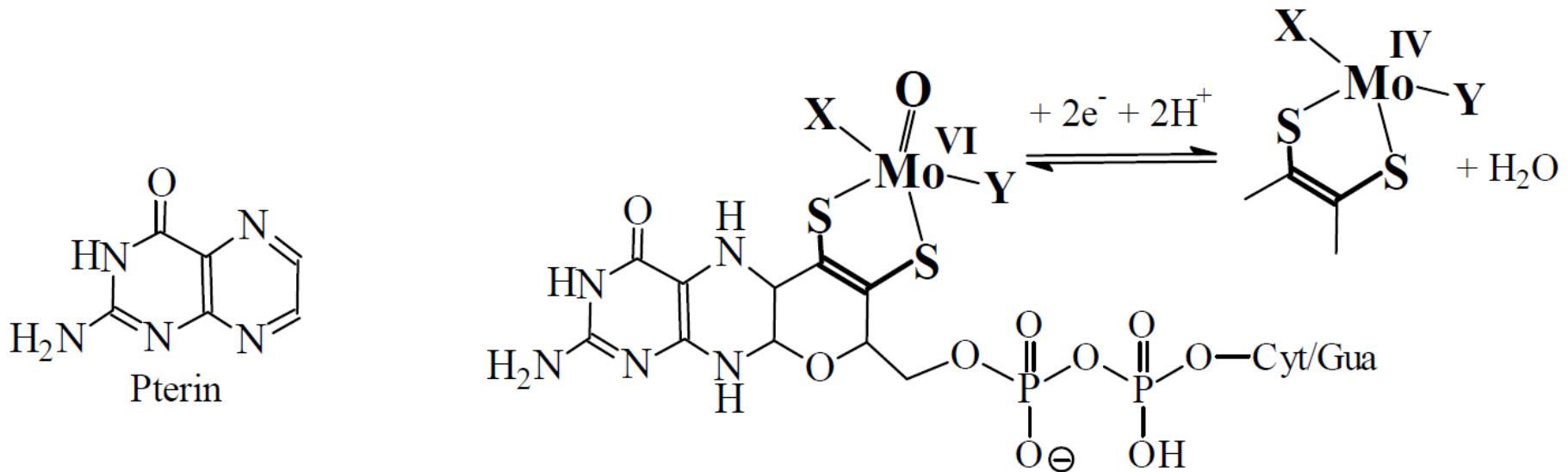
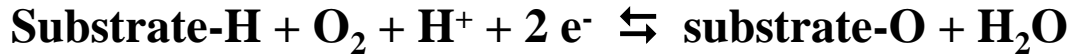

→ 2-electron-transfer-reactions

DMSO reductase: $(\text{CH}_3)_2\text{SO}_2 \rightarrow \text{methylsulphonic acid } (\text{CH}_3)_2\text{SO} \rightarrow \text{dimethyl sulphide } (\text{CH}_3)_2\text{S}$ “indicator for biological activity in sea birds“

10. Biochemistry of Transition Metals

The Chromium Group

Tungsten

- Sole element of 3rd transition metal series (5d) of biological importance
- Metal enzymes in hyper thermal archaeobacteria are stable up to 110 °C, since the strong metal-ligand-interactions stabilise these enzymes
- Stability of W-O-bonds → see tungstates
- Example: Acetylene hydratase $C_2H_2 + H_2O \rightarrow CH_3CHO$ (acetaldehyde)

Literature

- Coord. Chem. Rev. 255 (2011) 1039
- J. Mol. Microbiol. Biotechnol. 26 (2016) 119

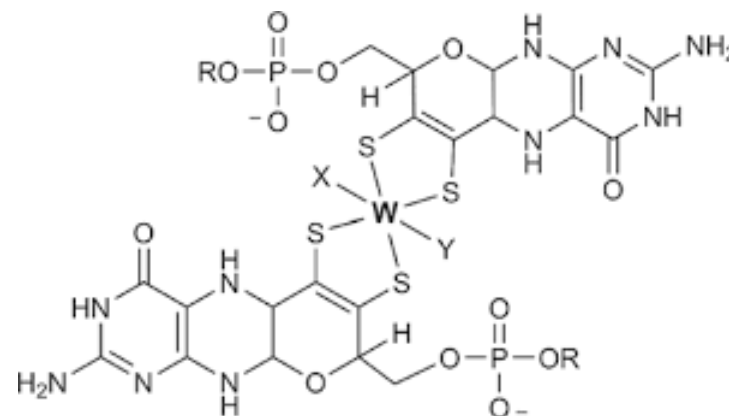

10. Biochemistry of Transition Metals

The Manganese Group

Manganese

Mn^{2+}	$[\text{Ar}]3d^5$	pale-rose	most stable (in the acidic pH range)
Mn^{3+}	$[\text{Ar}]3d^4$	red	tends to disproportionate
MnO_4^{4-}	$[\text{Ar}]3d^3$	brown	does not disproportionate
MnO_4^{3-}	$[\text{Ar}]3d^2$	blue	tends to disproportionate
MnO_4^{2-}	$[\text{Ar}]3d^1$	green	tends to disproportionate
MnO_4^-	$[\text{Ar}]$	violet	strong oxidizing agent

Technetium

Radioactive and extremely scarce

TcO_4^- [Kr] colourless activity ~ 30 millicuries

$^{99\text{m}}\text{Tc}$ ($t_{1/2} = 6$ h) in coordinated form is used in diagnostic nuclear medicine, as citrate or diphosphonato methane complex: Single Photon Emission Computed Tomography (SPECT)

Rhenium

Rhenium is extremely scarce and rhenium oxide is poorly soluble

Re^+ $[\text{Xe}]4f^{14}5d^6$ l.s. yellow to red CO_2 activation, marker

ReO_4^- $[\text{Xe}]4f^{14}$ colourless weakly oxidizing

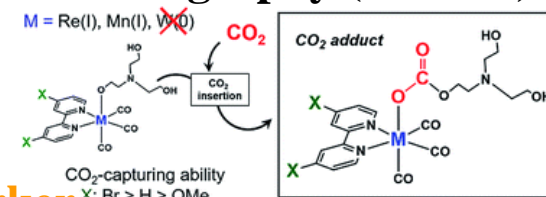

10. Biochemistry of Transition Metals

The Manganese Group

Manganese redox chemistry

- Metallic manganese tends to be oxidised $\text{Mn} \rightleftharpoons \text{Mn}^{2+} + 2 e^-$ $E^\circ = -1.19 \text{ V}$
- In acidic solution Mn^{2+} is the most stable oxidation state
- In alkaline solution Mn^{4+} is the most stable species but Mn^{2+} and Mn^{3+} possess similar stability

Frost diagram for manganese in acidic (right) and alkaline (left) solution

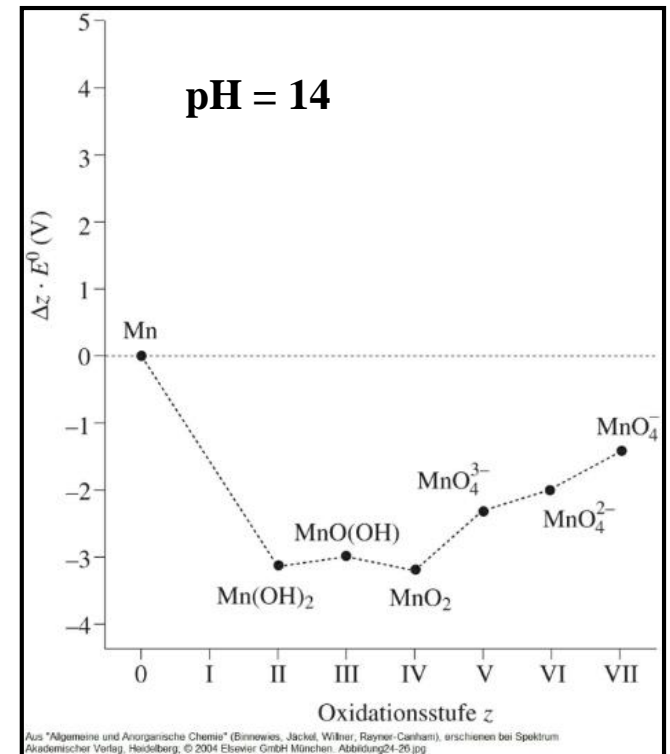
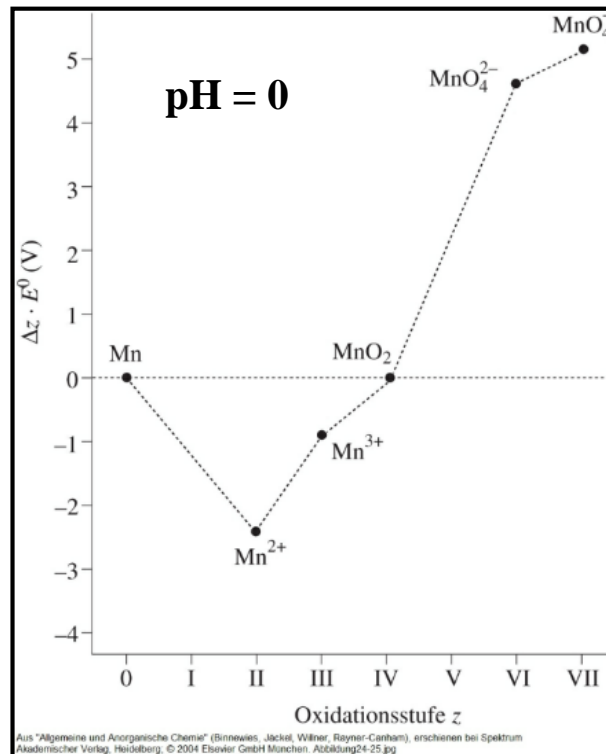

10. Biochemistry of Transition Metals

The Manganese Group

Oxidation state +II ([Ar]3d⁵)

- Mn²⁺ is relatively stable in comparison to other divalent TM-ions and not a reducing agent in acidic solution: E⁰ [V] at pH 0**

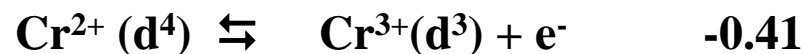
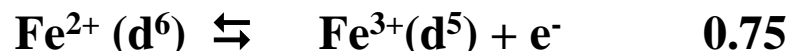

- Manganese(II)-salts or solutions are only weakly coloured since the absorption in the visible range is only possible via spin-forbidden 3d-3d-transitions (d⁵, high-spin)**

MnSO₄·7H₂O rose

MnCl₂·4H₂O rose

[Mn(H₂O)₆]²⁺ pale rose

- Strongly coloured low-spin complexes are formed only with very strong ligands, e.g.**

[Mn(CN)₆]⁴⁻

[Mn(CN)₅(NO)]³⁻

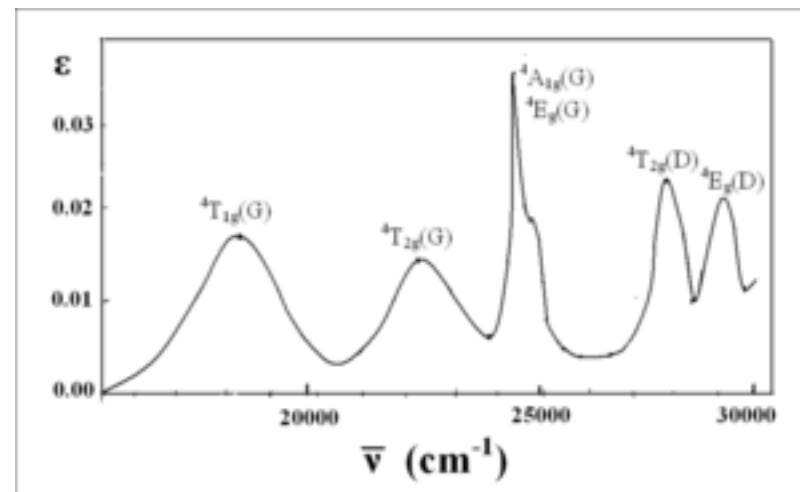

10. Biochemistry of Transition Metals

The Manganese Group

Oxidation state +III ([Ar]3d⁴)

- **Dissolution of braunite Mn₂O₃ in conc. H₂SO₄**
$$\text{Mn}_2\text{O}_3 + 6 \text{H}^+ + 9 \text{H}_2\text{O} \rightleftharpoons 2 [\text{Mn}(\text{H}_2\text{O})_6]^{3+}$$
results in a solution of the garnet red hexaaquamanganese(III)-ions
- **Manganese(III)-ions tend to disproportionation**
$$2 \text{Mn}^{3+} + 2 \text{H}_2\text{O} \rightleftharpoons \text{Mn}^{2+} + \text{MnO}_2 + 4 \text{H}^+$$
if no reducing agent is present
- **The stable, dark red manganese(III)-acetate is formed upon exposure of permanganate to manganese(II)-acetate in glacial acetic acid:**
$$3 \text{KMnO}_4 + 12 \text{Mn}(\text{OAc})_2 + 11 \text{HOAc} + 3 \text{H}^+ \rightarrow 5 [\text{Mn}_3\text{O}(\text{OAc})_6]\text{OAc} \downarrow + 7 \text{H}_2\text{O} + 3 \text{K}^+$$
(HOAc = CH₃-COOH)
- **Mixed-valent compounds are strongly coloured → MMCT (Intervalence compounds)**
$$[\text{L}_2\text{Mn}^{\text{II}}\text{Mn}^{\text{III}}(\mu\text{-OH})_3]^{2+} \quad \text{with L} = 1,4,7\text{-Trimethyl-1,4,7-triaza cyclononane}$$
$$[\text{L}_2\text{Mn}^{\text{III}}\text{Mn}^{\text{IV}}(\mu\text{-O})_2(\mu\text{-OH})]^{2+}$$

10. Biochemistry of Transition Metals

The Manganese Group

Oxidation state +IV ([Ar]3d³)

$\text{MnO}_2 \cdot \text{H}_2\text{O} = \text{MnO}(\text{OH})_2$ is a strong oxidizing agent in acidic solution

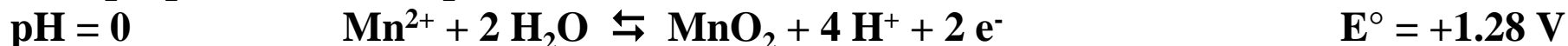

\Rightarrow lab-synthesis of chlorine



$\Rightarrow \text{O}_2$ oxidizes manganese(II)-hydroxide to $\text{MnO}_2 \cdot \text{H}_2\text{O}$

Oxidation state +VII ([Ar]3d⁰)

The violet permanganate ion MnO_4^- is a strong oxidizing agent in acidic solution



$$E = E^\circ + \frac{0.059}{5} \lg \frac{[\text{MnO}_4^-][\text{H}_3\text{O}^+]^8}{[\text{Mn}^{2+}]}$$

Permanganate can be formed through oxidation of Mn^{2+} with PbO_2 in acidic environment



10. Biochemistry of Transition Metals

The Manganese Group

Manganese in the biosphere

- Manganese is the key element in the light reaction of photosynthesis, i.e. it is needed to cleave water in the oxygen-evolving cluster:

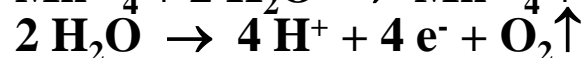
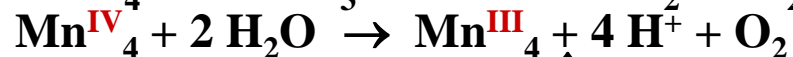

→ Photosystem II (light reaction)

- Arginase

Nitrogen-containing metabolite → urea synthesis $\text{H}_2\text{N-CO-NH}_2$

- Superoxide dismutase

Decomposition of superoxide radical O_2^-

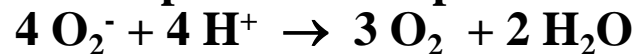

Mn besides Zn, Cu, Fe and Se is a co-factor for anti-oxidative acting enzymes

- Pyruvate carboxylase

Conversion of pyruvate in oxaloacetate by activation of HCO_3^-



Enzyme-biotin- CO_2 + pyruvate → enzyme-biotin + oxaloacetate

10. Biochemistry of Transition Metals

Photosynthesis: The Energetic Base of the Biosphere (Mn Catalysed H₂O Cleavage)

Venus

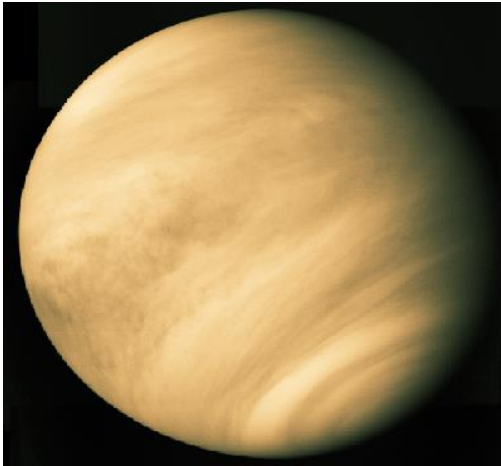

2.61 kW/m²
Albedo = 0.76
→ T_e = 232 K
96% CO₂ + 3% N₂ +
SO₂ + H₂O + Ar (ppm)
93 bar → T_{eff} = 740 K

Earth



1.37 kW/m² = 1.56 · 10¹⁸ kWh/a
Albedo = 0.30
→ T_e = 255 K
78% N₂ + 21% O₂ + 0.9% Ar
+ CO₂ + H₂O + CH₄ (ppm)
1 bar → T_{eff} = 288 K
Life = aqueous chemistry
Water → H₂ and O₂ → energy!

Mars

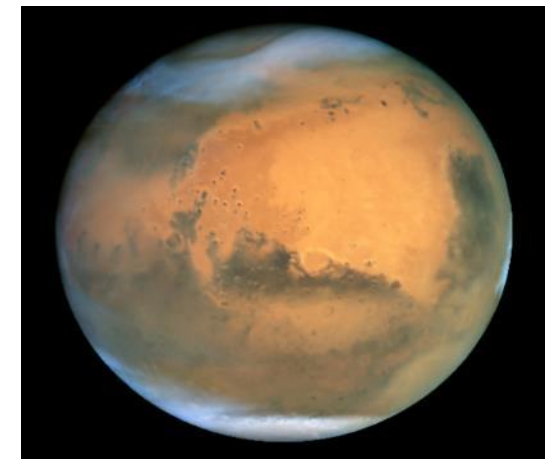

0.59 kW/m²
Albedo = 0.15
→ T_e = 213 K
95% CO₂ + 3% N₂ +
1.5% Ar + H₂O (ppm)
5.6 mbar → T_{eff} = 225 K

10. Biochemistry of Transition Metals

Photosynthesis: Almost All Energy Consumed by Living Organisms Stems from Solar Energy (Exception: Thermophiles in the Deep Sea)

Energy source in solar system: The sun

Luminosity (radiation flux) $3.8 \cdot 10^{26}$ W
Annual radiation power $1.24 \cdot 10^{34}$ J (presently!)

Habitable zone

Venus (early stage of solar system), earth (today), mars (late phase...)

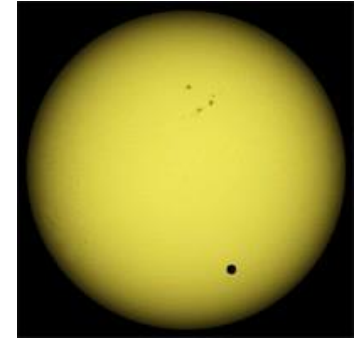

Venus transit

Planet	Perihelion- and aphelion-distance in astronomic units	Solar radiation maximum und minimum (W/m ²)
Mercury	0.3075 – 0.4667	14,446 – 6,272
Venus	0.7184 – 0.7282	2,647 – 2,576
Earth	0.9833 – 1.017	1,413 – 1,321
Mars	1.382 – 1.666	715 – 492
Jupiter	4.950 – 5.458	55.8 – 45.9
Saturn	9.048 – 10.12	16.7 – 13.4
Uranus	18.38 – 20.08	4.04 – 3.39
Neptune	29.77 – 30.44	1.54 – 1.47

10. Biochemistry of Transition Metals

Photosynthesis: Almost All Energy Consumed by Living Organisms Stems from Solar Energy (Exception: Thermophiles in the Deep Sea)

Energy flux in solar system

	Radiation flux [W]	Irradiance I [W/m ²]	Energy flux / day [J]
Sun	$3.8 \cdot 10^{26}$	$6.37 \cdot 10^7$	$3.3 \cdot 10^{31}$
	↓	$(r_{\text{Sun-earth}}^2 / r_{\text{sun}}^2 \sim 46200)$	↓
Earth	$7.0 \cdot 10^{17}$	1420 (Aphelion) 1328 (Perihelion) 1367 (Extraterrestrial solar constant) = I_C	$6.0 \cdot 10^{22}$

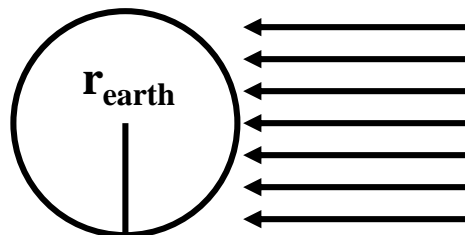

solar
radiation

$$\text{Global } I_C = \pi r_{\text{earth}}^2 / 4\pi r_{\text{earth}}^2 = I_C / 4$$

$$\text{Global albedo (reflectance) } a_g = 0.3$$

10. Biochemistry of Transition Metals

Photosynthesis : Solar Irradiation on Earth

- Extraterrestrial solar constant $I_C = 1367 \text{ W/m}^2$
- Global extraterrestrial irradiation $I_{CG} = (1-a_g) \cdot 1/4 \cdot I_C = 239 \text{ W/m}^2$ (absorbed)
- Earth's surface $510 \cdot 10^{12} \text{ m}^2$ (**510 Mill. km²**)
- Global absorbed solar energy per year $3.86 \cdot 10^{24} \text{ J} \Rightarrow 1.2 \cdot 10^5 \text{ TJ/s (TW)}$
- Annual biomass production $1.7 \cdot 10^{14} \text{ kg}$
 $\Rightarrow \sim 1.0 \cdot 10^{17} \text{ kJ}$ ($\Delta G^0(\text{hexose}) = 2872 \text{ kJ/mol}$)

Primary energy consumption (1998)

- World 14 TW ($\cong 1.2 \cdot 10^{10} \text{ t coal}$) $\Rightarrow \sim 4.4 \cdot 10^{17} \text{ kJ}$ (2016: 16 TW $\Rightarrow \sim 5.2 \cdot 10^{17} \text{ kJ}$)
- USA 3 TW
- FRG 0.5 TW
- Photovoltaics (energy efficiency $\sim 15\%$)
 $510 \times 10^{12} \text{ m}^2 \cdot (14 \text{ TW} / 1.2 \cdot 10^5 \text{ TW}) / 0.15 = 4 \times 10^{11} \text{ m}^2 \approx \mathbf{0.4 \text{ Mill. km}^2} \approx 0.08\% \text{ of Earth s.}$

Fossil fuels

- Global resources $m_{O_2} = 10^{15} \text{ t}$ (O_2 in atmosphere) $\rightarrow 400 \cdot 10^{12} \text{ t C}$
- Known resources $10.4 \cdot 10^{12} \text{ t C}$ ($\sim 2.5\%$)

10. Biochemistry of Transition Metals

Photosynthesis: Spectral Distribution of Radiation upon Earth's Surface

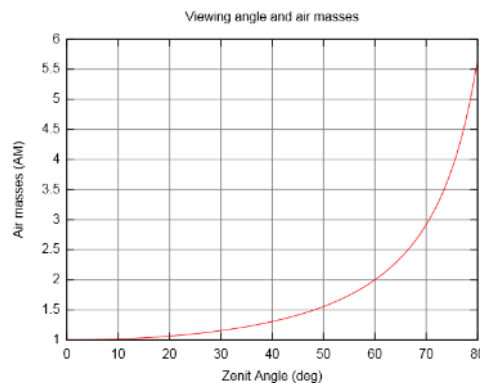
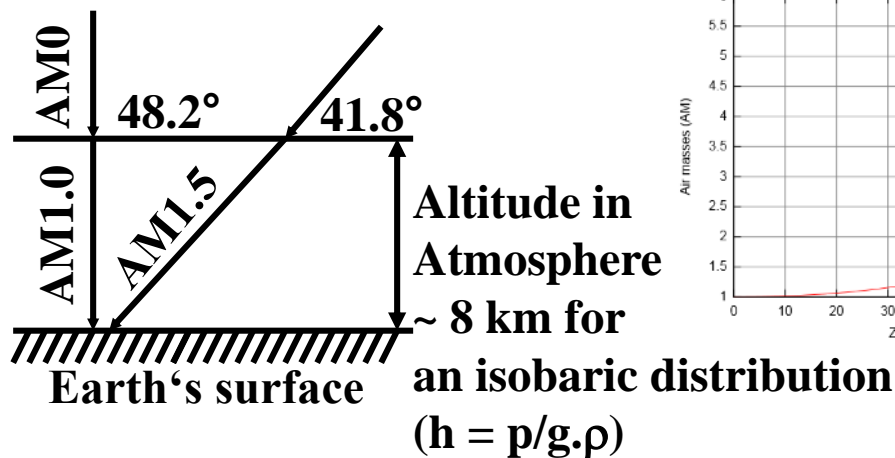

AM = Air mass

AM	1.5 (global)
UV ~	5%
VIS ~	51%
IR ~	44%

Solar energy production in thin layers, e.g. leafs, require strong absorbents (antenna molecules)
Absorption constant $\epsilon > 1 \cdot 10^4 \text{ cm}^{-1} \text{ M}^{-1}$ 400 – 700 nm
⇒ chlorophyll, carotin, phycocyanin, phycoerthrin

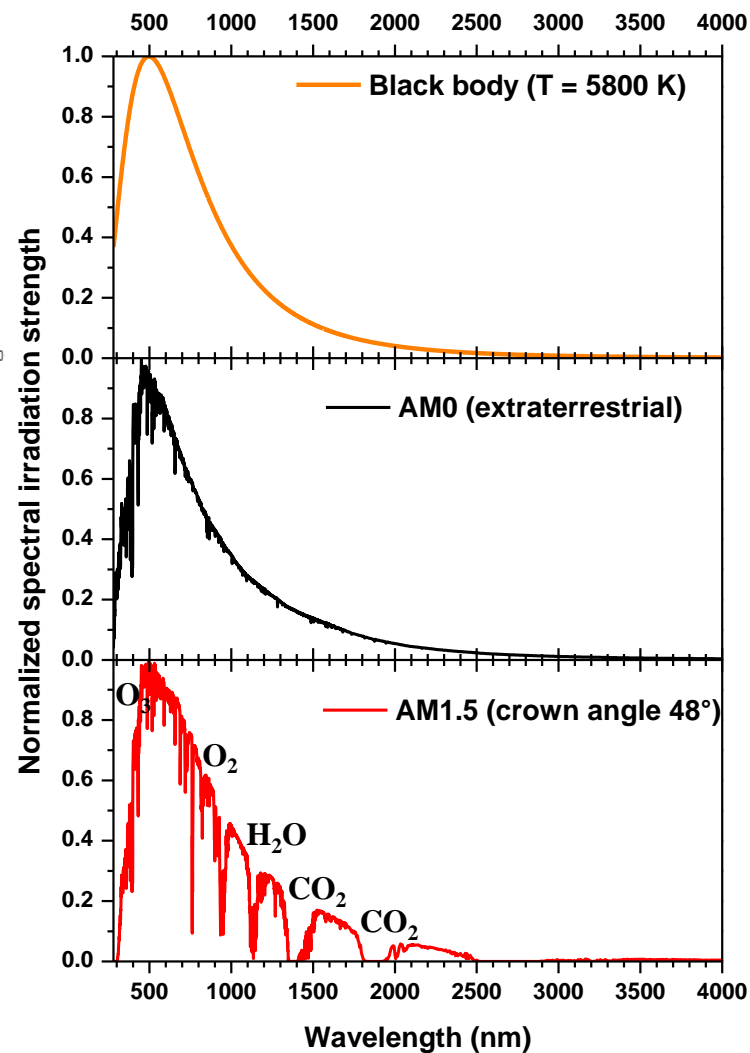

10. Biochemistry of Transition Metals

Photosynthesis: Absorption of Irradiated Solar Energy

$$A + R + T = 1$$

with **A = Absorption**, **R = Reflection (albedo)**, **T = Transmission**

Irradiation of earth

$$T = 0 \Rightarrow A = 1 - R$$

<u>Surface of</u>	<u>R (albedo)</u>	<u>Solar energy use</u>	<u>Absorber</u>	<u>Absorption process</u>
Earth	10 – 25%	Si-solar cells	Silicon	VB – CB transitions
Sand	25 – 40%	Grätzel-solar cells	Ru ²⁺ complexes	Metal-to-Ligand-Charge-Transfer (MLCT)
Grass	15 – 25%			
Forrest	10 – 20%	Chloroplasts	Chlorophyll β-carotin & other accessory pigments	π - π*, n - π*
Snow	75 – 95%			
Sea	10%			
Earth (global)	30%			

High absorption strength only by allowed optical transitions

10. Biochemistry of Transition Metals

Photosynthesis: Applications of Irradiated Solar Energy

1. Absorption	Energy transfer via excitons	Excited species
2. Light reaction	Energy uptake	Formation of H₂ and ATP
3. Dark reaction	Energy storage	Biomass, batteries, etc.

Technical and biological applications

• Solarthermics	Light → thermal energy	Solar collectors
• Photovoltaics	Light → electrical energy	Solar cells
		1. Semi-conductor (Si, Ge)
		2. Liquids (Grätzel)
• Photosynthesis $n \text{CO}_2 + n \text{H}_2\text{O}$	Light → chemical energy Photosynthesis $\xrightarrow{h\nu}$ $n \text{O}_2\uparrow + (\text{CH}_2\text{O})_n$ (biomass)	Algae, plants Mineralisation $\xrightarrow{-n \text{H}_2\text{O}}$ $n \text{C}$ (fossil fuels)

10. Biochemistry of Transition Metals

Photosynthesis: Energy Production in Autotrophic Organisms

- **Light reaction** **photolysis of a hydrogen donor (energy uptake)**

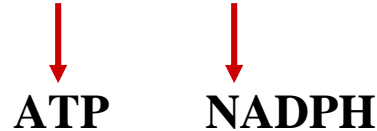
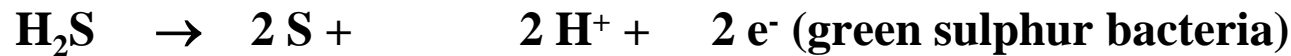

Photosynthetic Active Radiation (PAR) = 400 – 700 nm (170 – 300 kJ/mol)

- **Dark reaction** **Synthesis of carbohydrates (energy storage)**



Photosynthetic CO_2 fixation in glucose requires about 470 kJ/mol per C-Atom

Photochemical work

$$W = I \cdot A \cdot \Phi$$

with

I = Irradiance [W/m^2]

A = Absorption [0.0 ... 1.0]

Φ = Quantum yield [0.0 ... 1.0]

10. Biochemistry of Transition Metals

Photosynthesis: Oxygen production as a side effect → O₃ layer formation

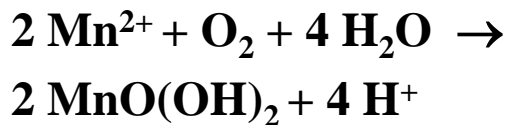
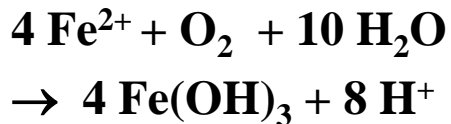

→ Fe and Mn deficiency
→ Self inhibition of photosynthesis

Carbon age: Invention of lignin
→ strong CO₂ reduction and O₂ concentration rose to 30-35%

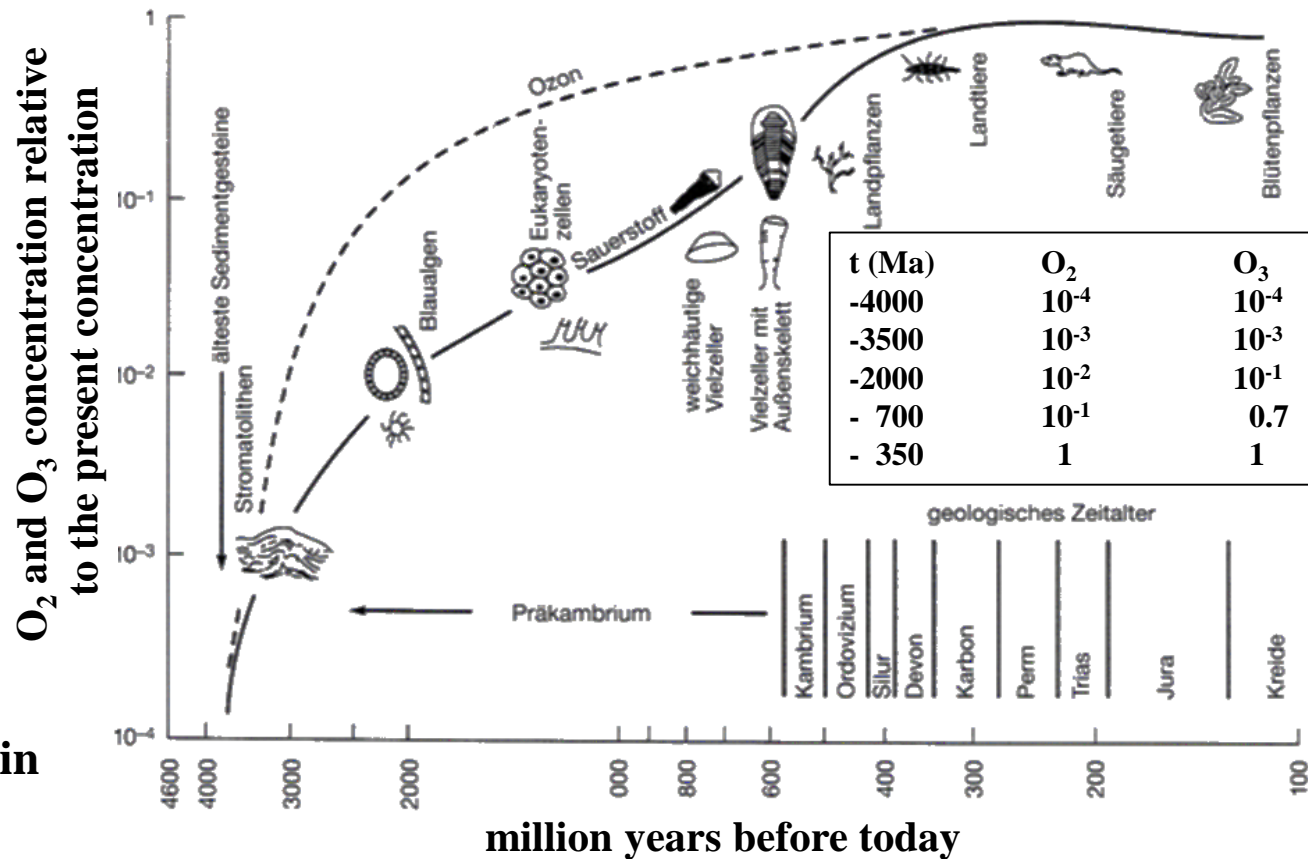

Source: Graedel Crutzen 1994

10. Biochemistry of Transition Metals

Photosynthesis: Location and Structure of Chloroplasts

Cross-section of a leaf of a higher plant

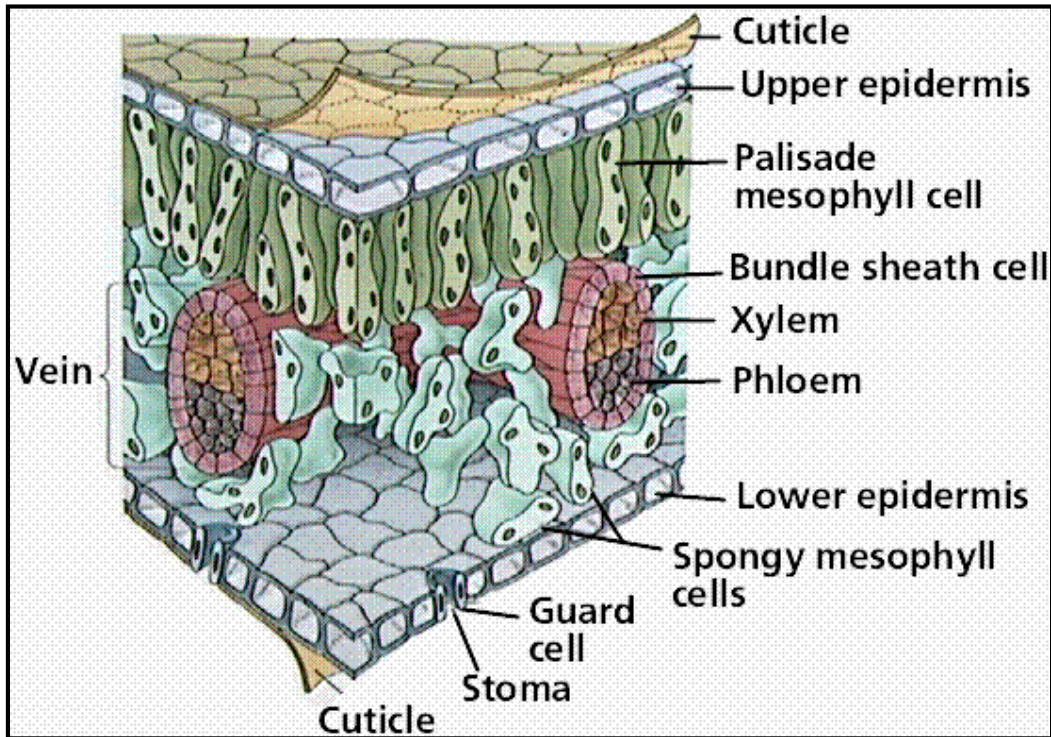

Schematic built of a chloroplast

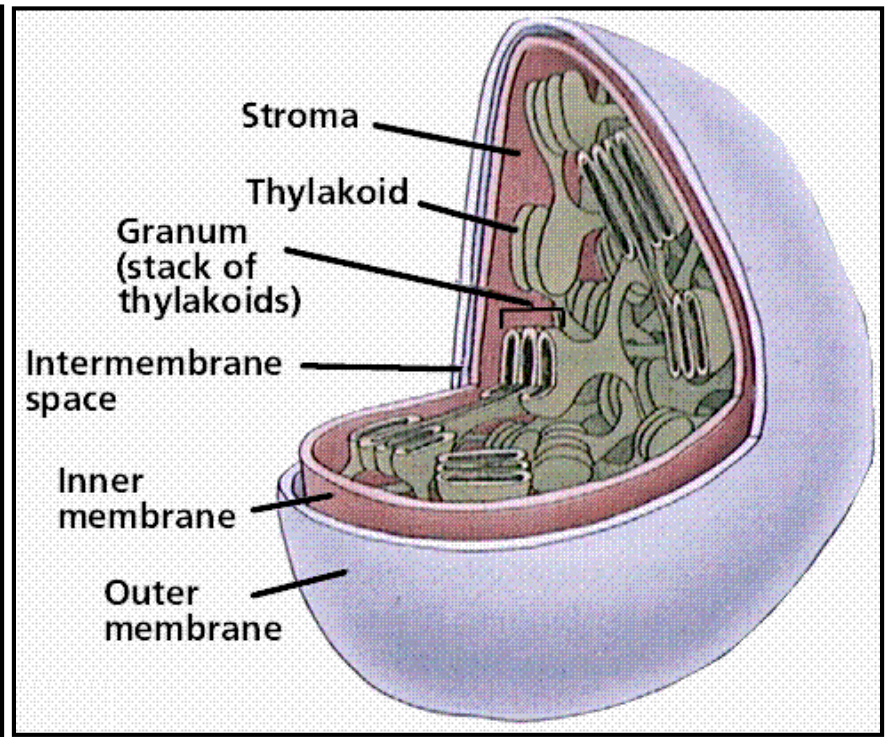

Photosynthetic activity takes place in thylakoid membranes

- Membrane potential $\sim 0.2 \text{ V}$
- Lipid/protein-ratio $\sim 1:1$

10. Biochemistry of Transition Metals

Photosynthesis: Antenna Dyes

Dye

Substances absorbing light selectively, resulting in a subtractive colour spectrum

Chlorophyll a, b

Green dye, present in all photosynthetically active cells, and absorbing in the blue and red spectral range

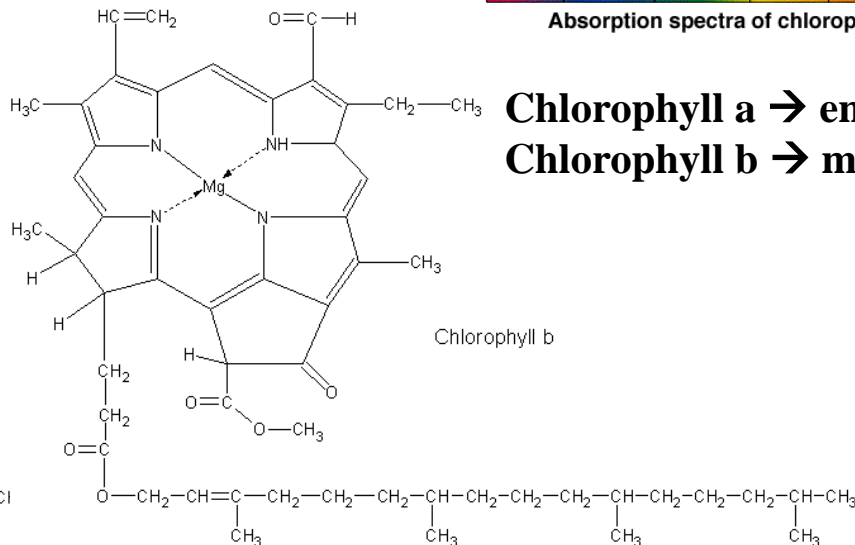
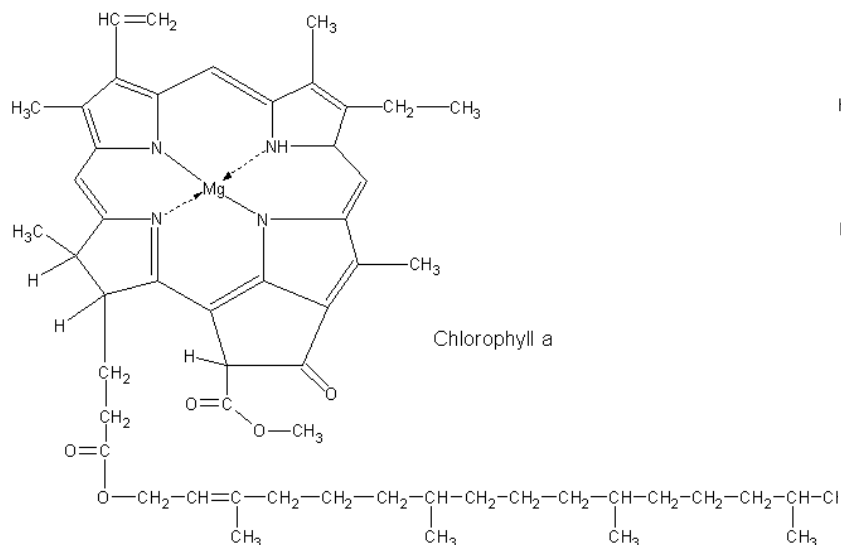

Absorption of Light by Chlorophylls a and b

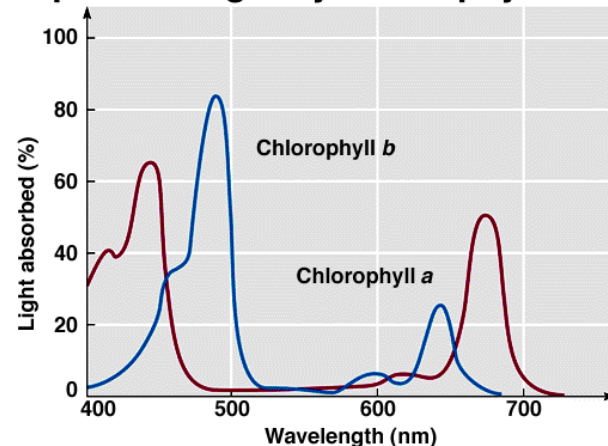

Absorption spectra of chlorophylls a and b.

Chlorophyll a → energy transfer
Chlorophyll b → main absorber

10. Biochemistry of Transition Metals

Photosynthesis: Antenna Dyes

Accessory pigments

Dyes which completes the absorption spectrum of chlorophyll in the visible range:

β -Carotin, lycopene, phycocyanin, phycoerythrin, ...

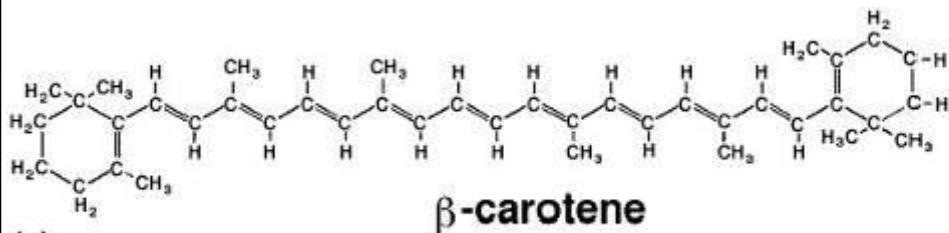

(a)

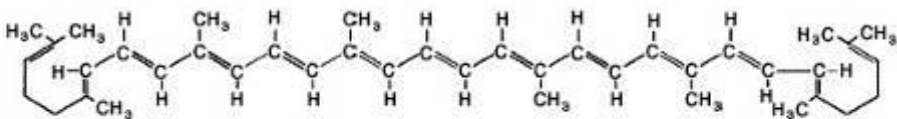

(b)

Lycopene

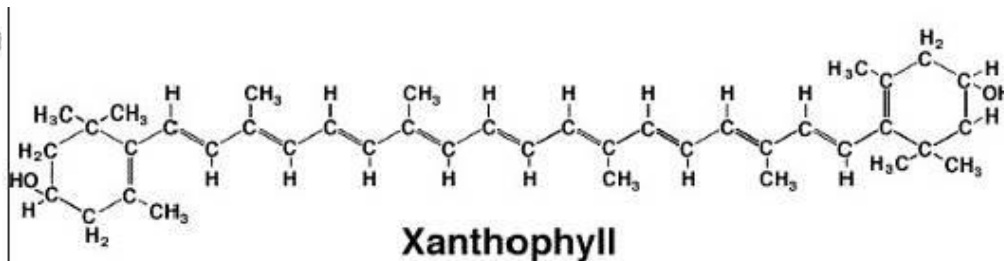

Xanthophyll

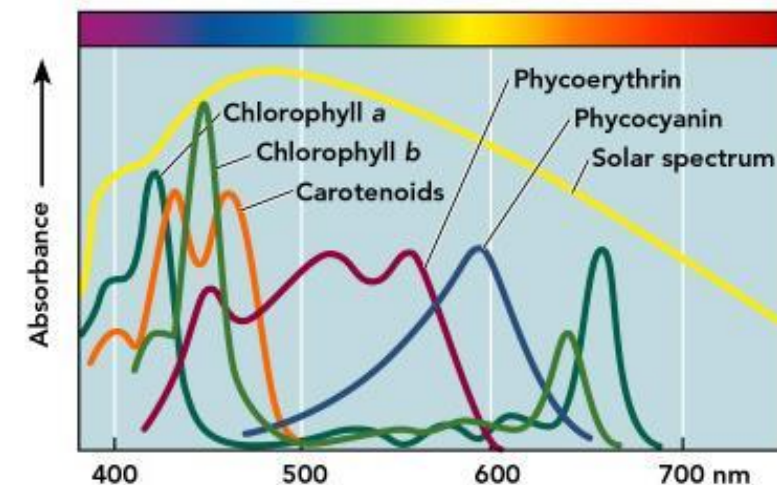

(b) Absorption of pigments

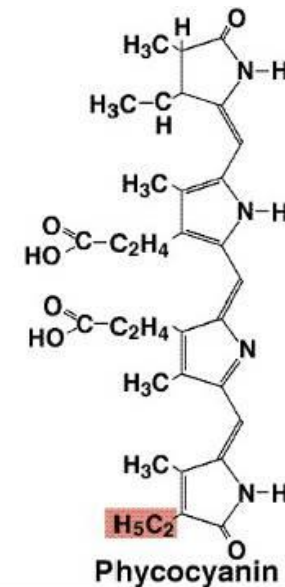

Phycocyanin

10. Biochemistry of Transition Metals

Photosynthesis: Antenna Dyes

Energy transfer (ET) to
reaction centre **Photosystem II**
(**PS II**)

Problem: Formation of singlet Oxygen,
which may destroy proteins

- ${}^1\text{Chl} + h\nu \rightarrow {}^1\text{Chl}^*$
- ${}^1\text{Chl}^* \rightarrow {}^3\text{Chl}^*$
- ${}^3\text{Chl}^* + {}^3\text{O}_2 \rightarrow {}^1\text{Chl} + {}^1\text{O}_2$

Solution: Mg^{2+} incorporation
prevents formation of ${}^3\text{Chl}^*$
due its weak spin-orbit coupling

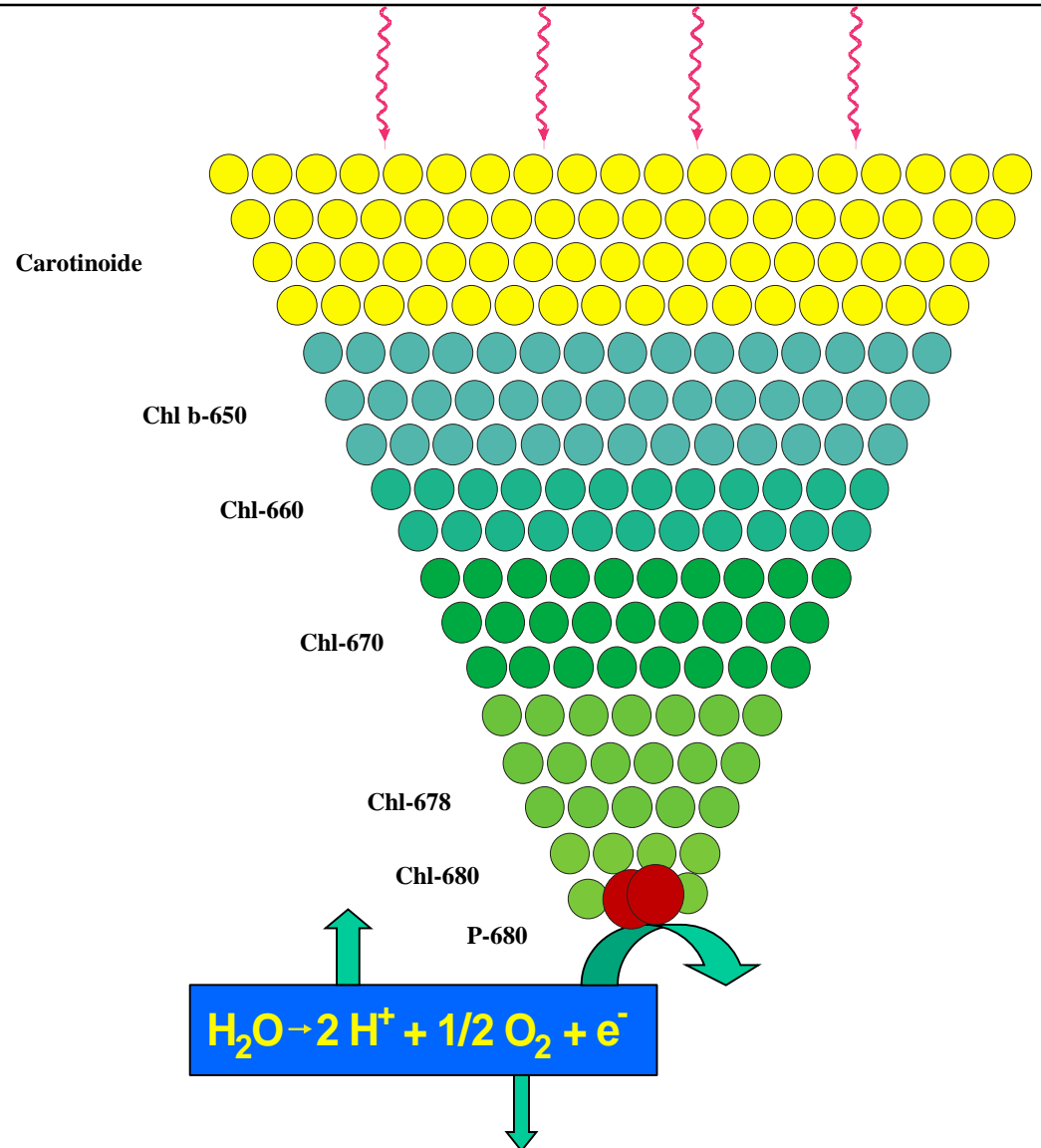

10. Biochemistry of Transition Metals

Photosynthesis: Absorption of Irradiated Solar Energy

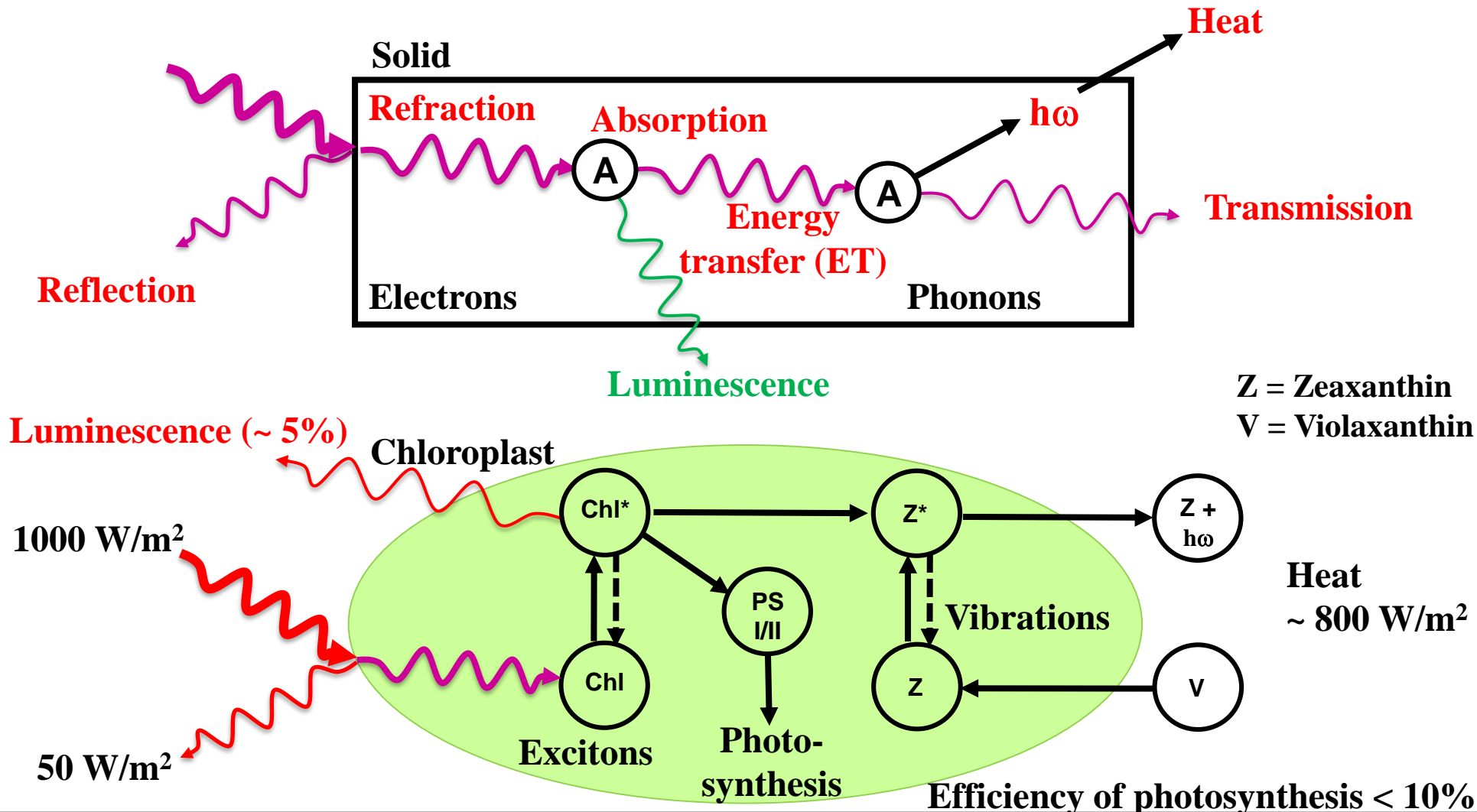

10. Biochemistry of Transition Metals

Photosynthesis: Time scales

- Absorption photon: ground-state → singlet state 10^{-15} s
- Higher singlet-state → singlet state $10^{-14} - 10^{-13}$ s
- Lowest singlet state → ground state $10^{-11} - 10^{-9}$ s
- Lifetime triplet state $10^{-4} - 10^{-2}$ s
(not relevant)

- Transfer of energy between adjacent molecules 10^{-10} s
- Transfer of energy to trigger chemical reactions 10 ms
(ET to reaction centre)

10. Biochemistry of Transition Metals

Photosynthesis: Fluorescence of Chlorophyll

- **Pure chlorophyll + blue light**
 - intensive red fluorescence
 - no energy migration
- **Chlorophyll in chloroplast + light**
 - weak fluorescence
 - Energy transfer to PSI/II

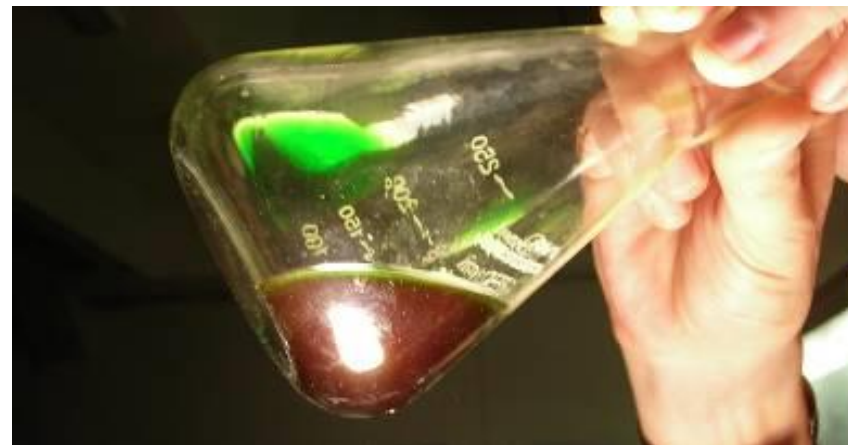

10. Biochemistry of Transition Metals

Photosynthesis: Action Spectra

Absorbed energy in PSI and II

1. Heat dissipation 80%
2. Luminescence 3-7%
3. Chemical reactions 10-15%
e.g. chlorophyll and sugar synthesis

Action spectra

Relative activity of different photon energies to achieve a measurable effect

→ Similar absorption spectrum compared to that of chlorophyll

Taken from DIN 5031-10

Chlorophyll synthesis action spectra

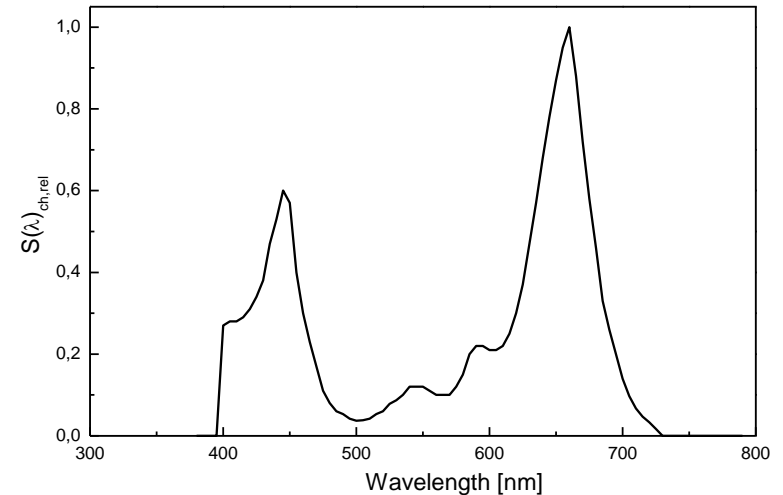

Photosynthesis action spectra

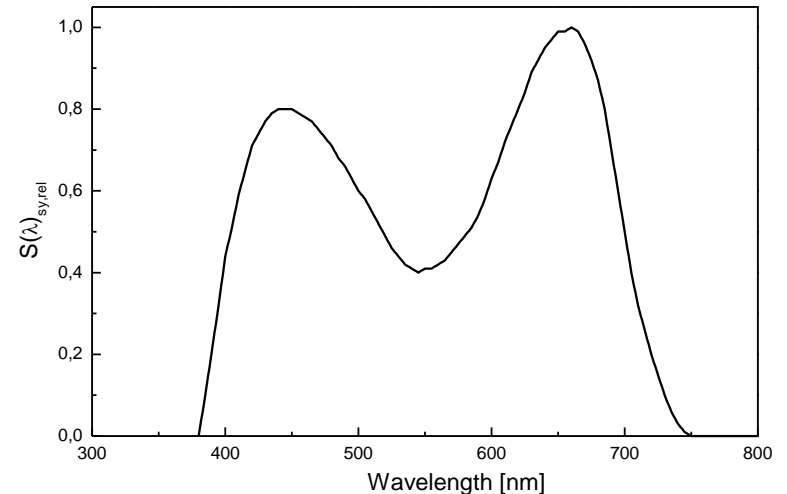

10. Biochemistry of Transition Metals

Photosynthesis: Emerson-Experiment

⇒ The light reaction consists of coupled photo systems: photosystem I and II

Photosystem II: Absorption up to 680 nm (P 680)

Photosystem I: Absorption up to 700 nm (P 700)

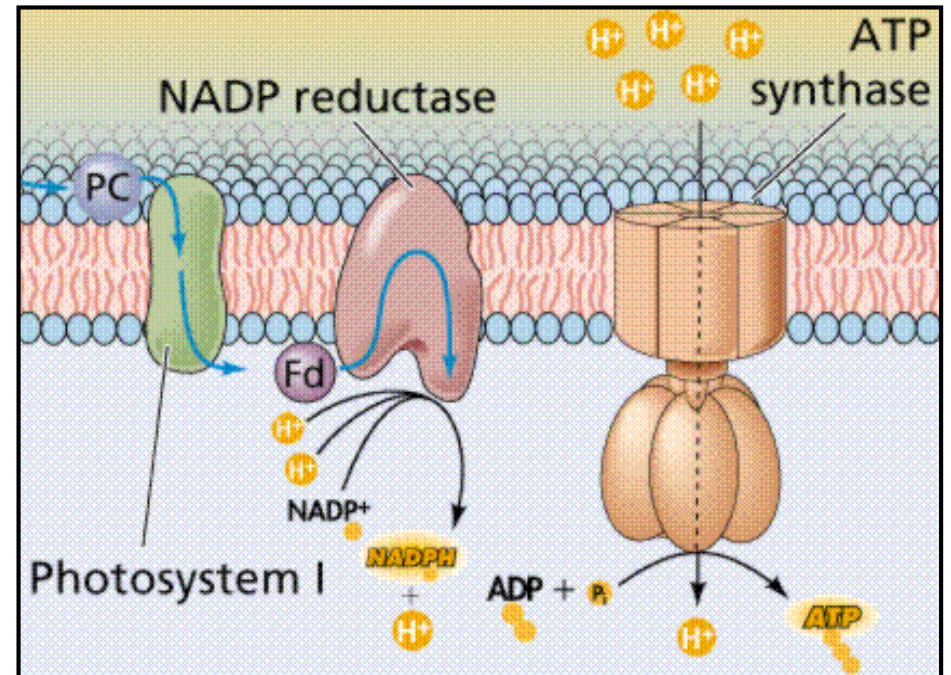
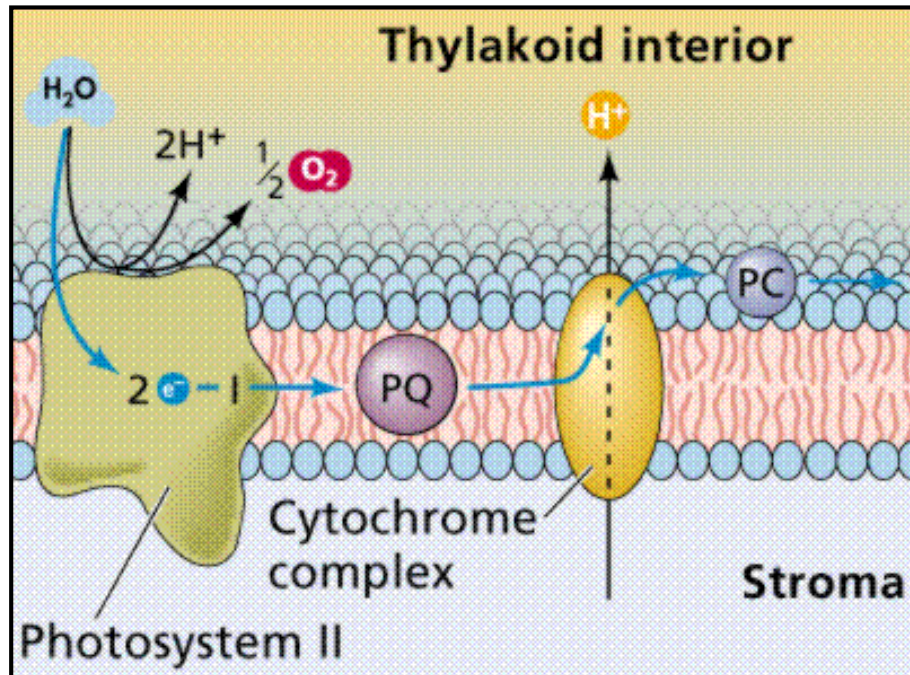

10. Biochemistry of Transition Metals

Photosystem I and II: Electron Flux

Mn-cluster

Plastoquinone (Q)

Cytochrome-complex

Plastocyanin (PC)

Ferredoxin (Fd)

NADP⁺ reductase

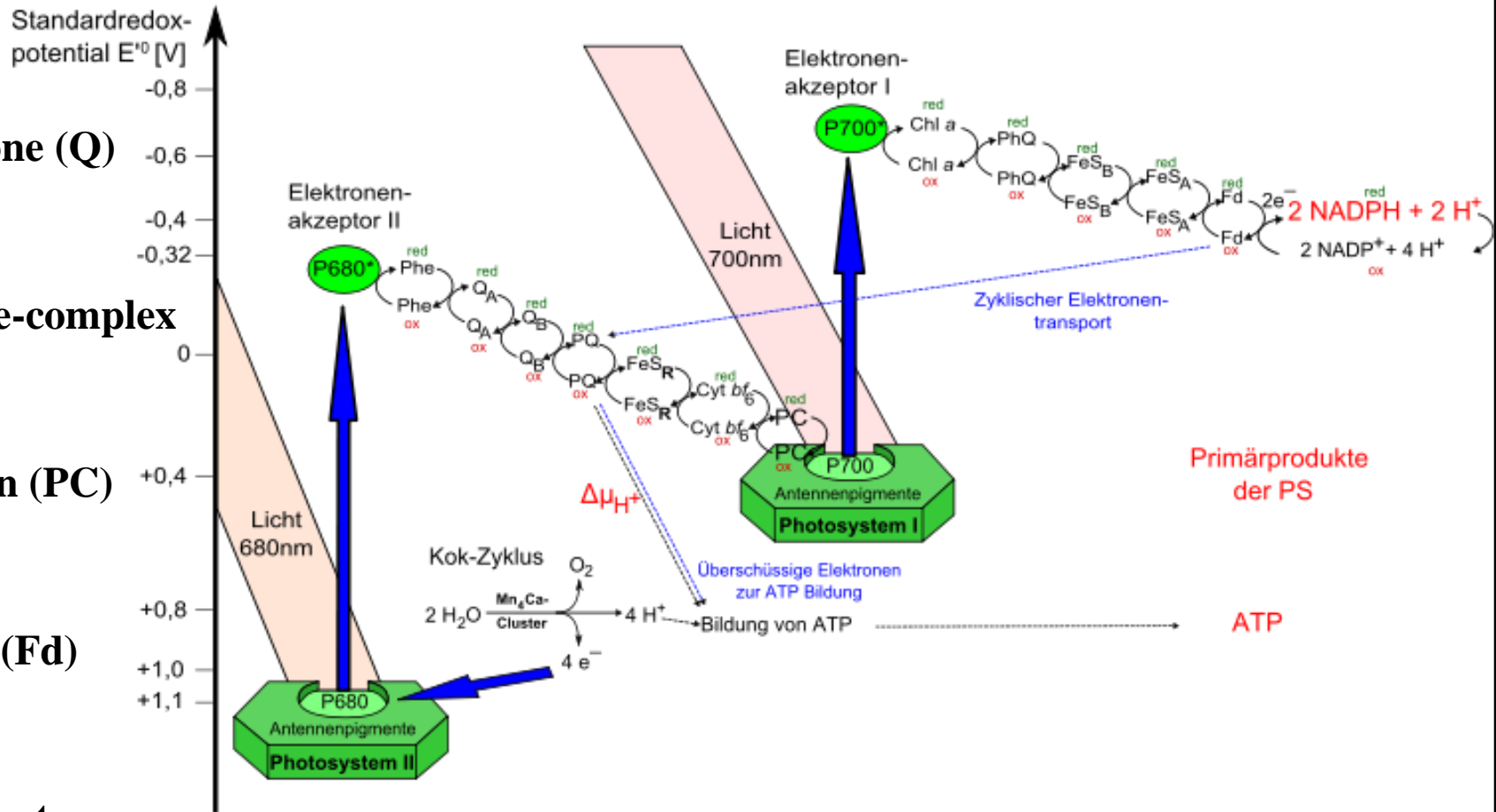

10. Biochemistry of Transition Metals

Photosynthesis: Structure of Photosystems II (Dimer), $M = 350$ kDa (cyanobacteria)

Electron density on the surface of PS II:
(cyanobacterium: *Synechococcus elongatus*)

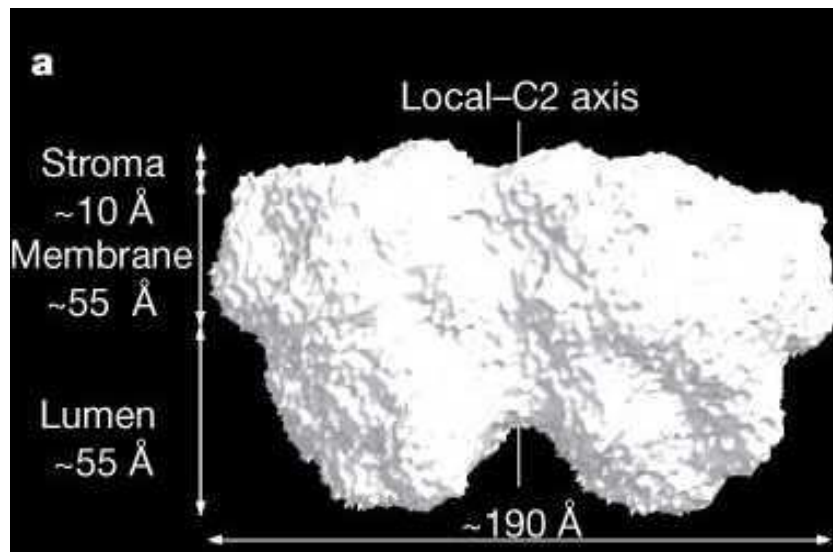

- Central Mn-cluster contains four Mn-ions, Ca^{2+} and Cl^-
- 2 Mn-Mn distances of 2.7 Å
- 1 Mn-Mn distances of 3.3 Å

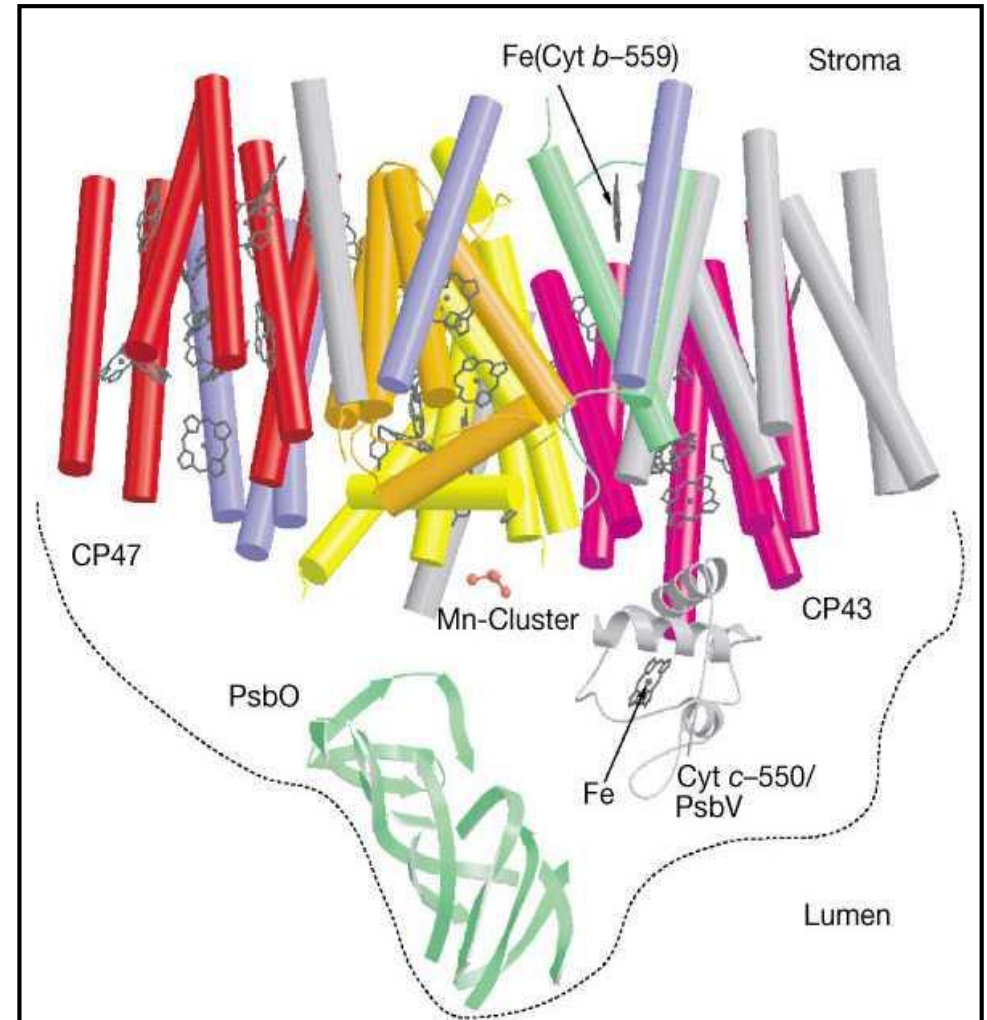

10. Biochemistry of Transition Metals

Photosynthesis: Structure of Photosystem II – Spectroscopic Analysis

a) Extended X-ray Absorption at Fine Structure (EXAFS)

→ determination of distances between heavy atoms (Mn- and Ca-ions)

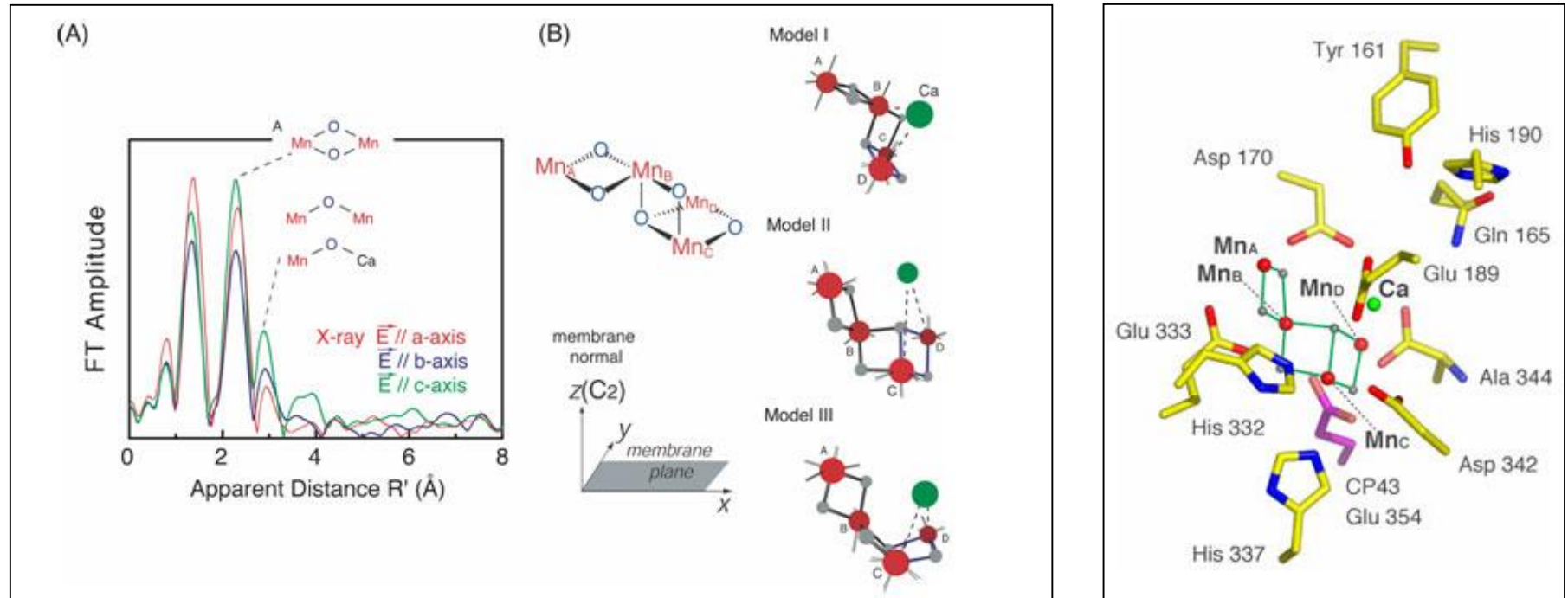

b) EPR-spectroscopy → oxidation state of the manganese atoms

c) T-dependent magnetic susceptibility → magnetic coupling (super-exchange)

10. Biochemistry of Transition Metals

Photosynthesis: Oxidation State of Mn-Cluster (Oxygen Evolving Center OEC)

d) Photolysis experiments

Findings:

- Oxygen evolution is oscillating (S0 S4)
- Oxidation occurs upon excitation of P680 to P680*
- P680* oxidises the OEC (via a Tyr-side chain)
- Mn²⁺ is gradually oxidised to Mn⁵⁺
- O₂ is probably released from an in-situ formed peroxy-unit
(hints from structures of model complexes)

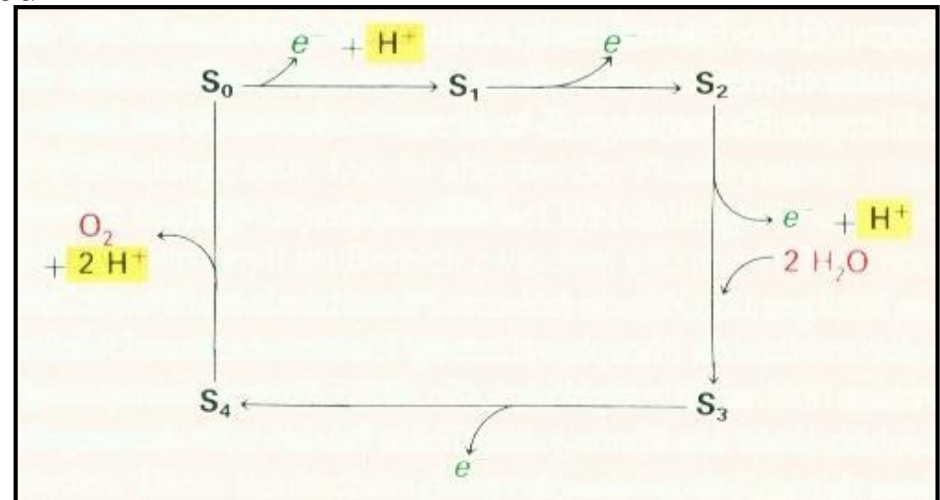
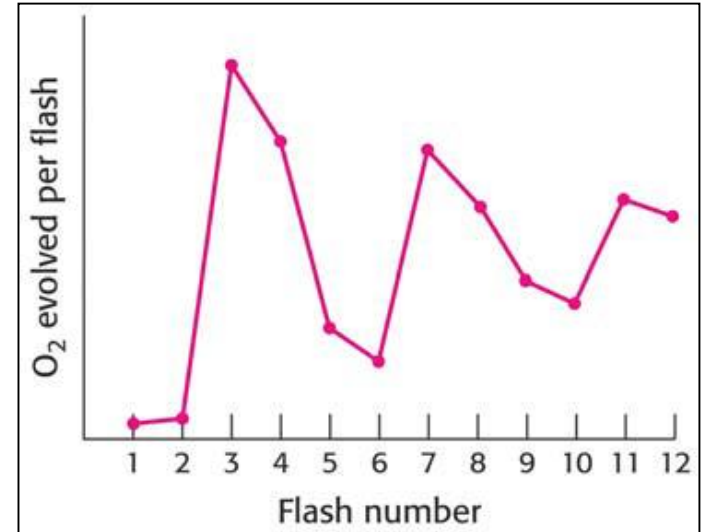

10. Biochemistry of Transition Metals

Photosynthesis: Mechanism of Water Cleavage in the Mn-Cluster

→ The Mn-cluster acts as a “homogeneous catalyst“: Models exist for oxo-bridged Mn^{4+} ions

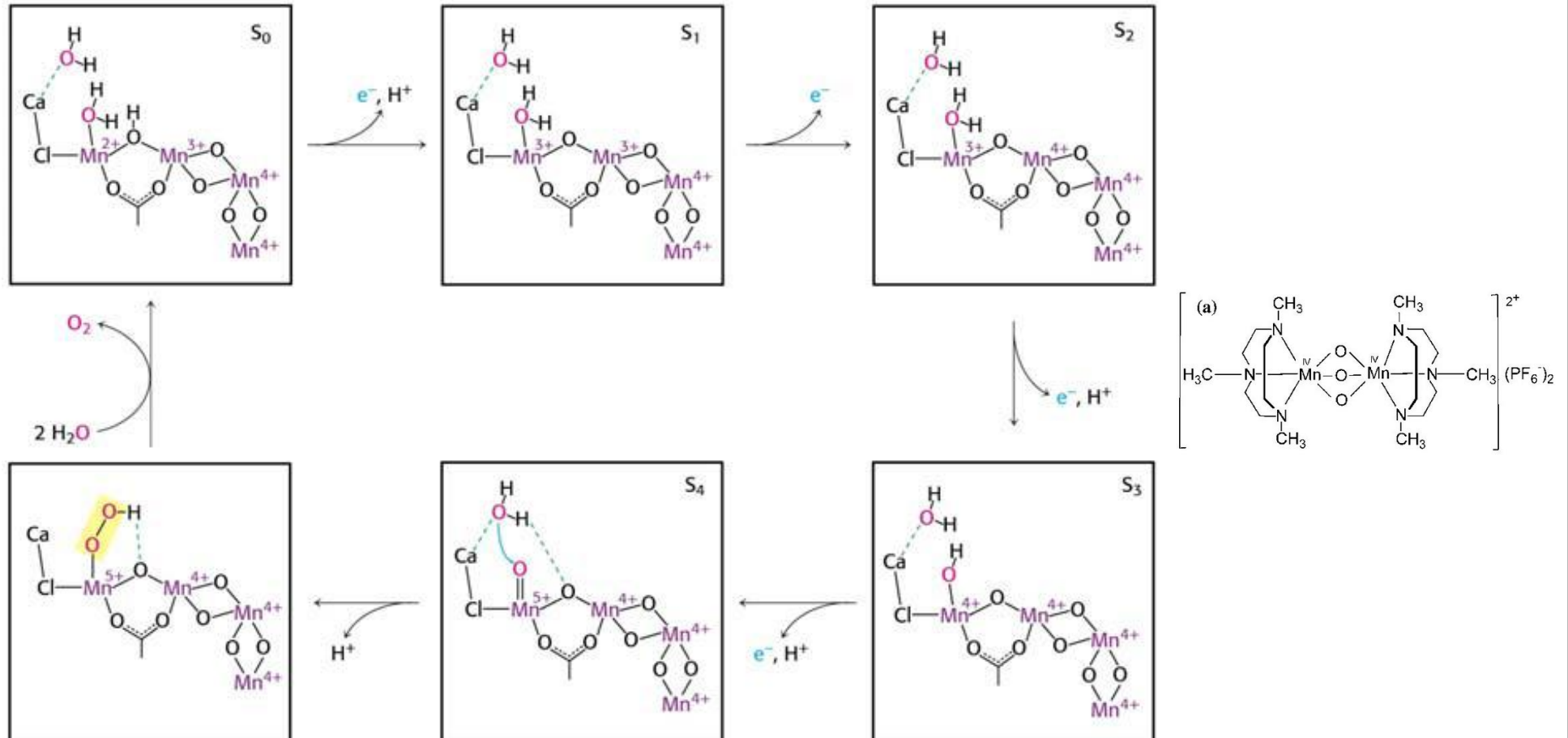

10. Biochemistry of Transition Metals

Photosynthesis: Formation of the Biochemical Energy Source ATP by a Electrochemical Gradient



$$\rightarrow \Delta\text{pH} \sim 3.5$$

$$\begin{aligned} \Delta E &= E_1 - E_2 \\ &= 0.059/z \cdot \log(c_1/c_2) \\ &= 0.059 \cdot \Delta\text{pH} \\ &= 0.2 \text{ V} \end{aligned}$$

$$\Delta G = -n \cdot F \cdot \Delta E = -20 \text{ kJ/mol}$$



$$\Delta G = 30.5 \text{ kJ/mol}$$

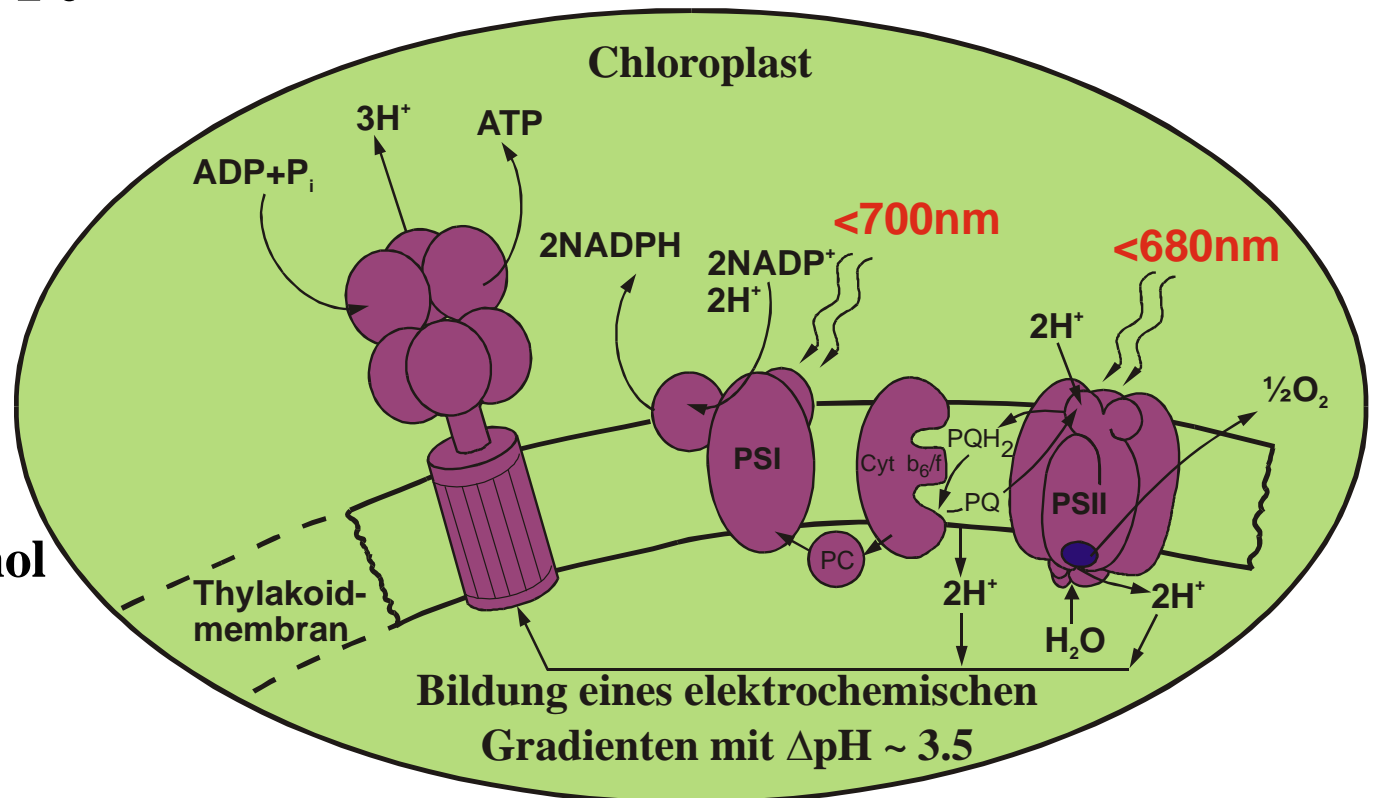

10. Biochemistry of Transition Metals

Photosynthesis: The mobile Electron Transport System Quinone / Hydroquinone

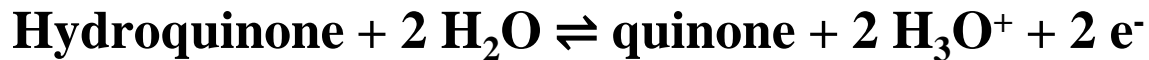
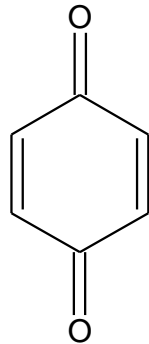
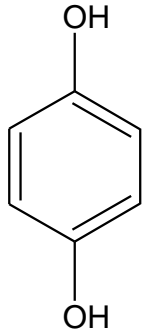

$$E^0 = - 0.70 \text{ V}$$

$$E = E^0 + \frac{0.059}{z} \lg \frac{[\text{quinone}][\text{H}_3\text{O}^+]^2}{[\text{hydroquinone}]} = E^0 + \frac{0.059}{z} \lg \frac{[\text{quinone}]}{[\text{hydroquinone}]} - 0.059 \cdot \text{pH}$$

Biochemically important quinone/hydroquinone-systems

Plastoquinone

Ubiquinone (coenzyme Q)

Tocopherol (vitamin E) →

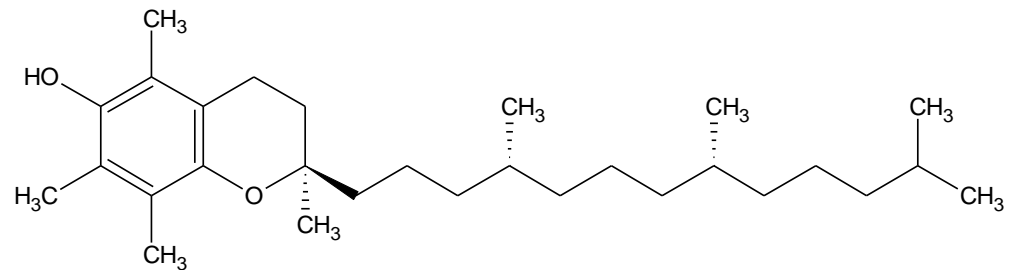

⇒ Electron transport between PSI and PSII

10. Biochemistry of Transition Metals

Photosynthesis: Summary of All Relevant Processes

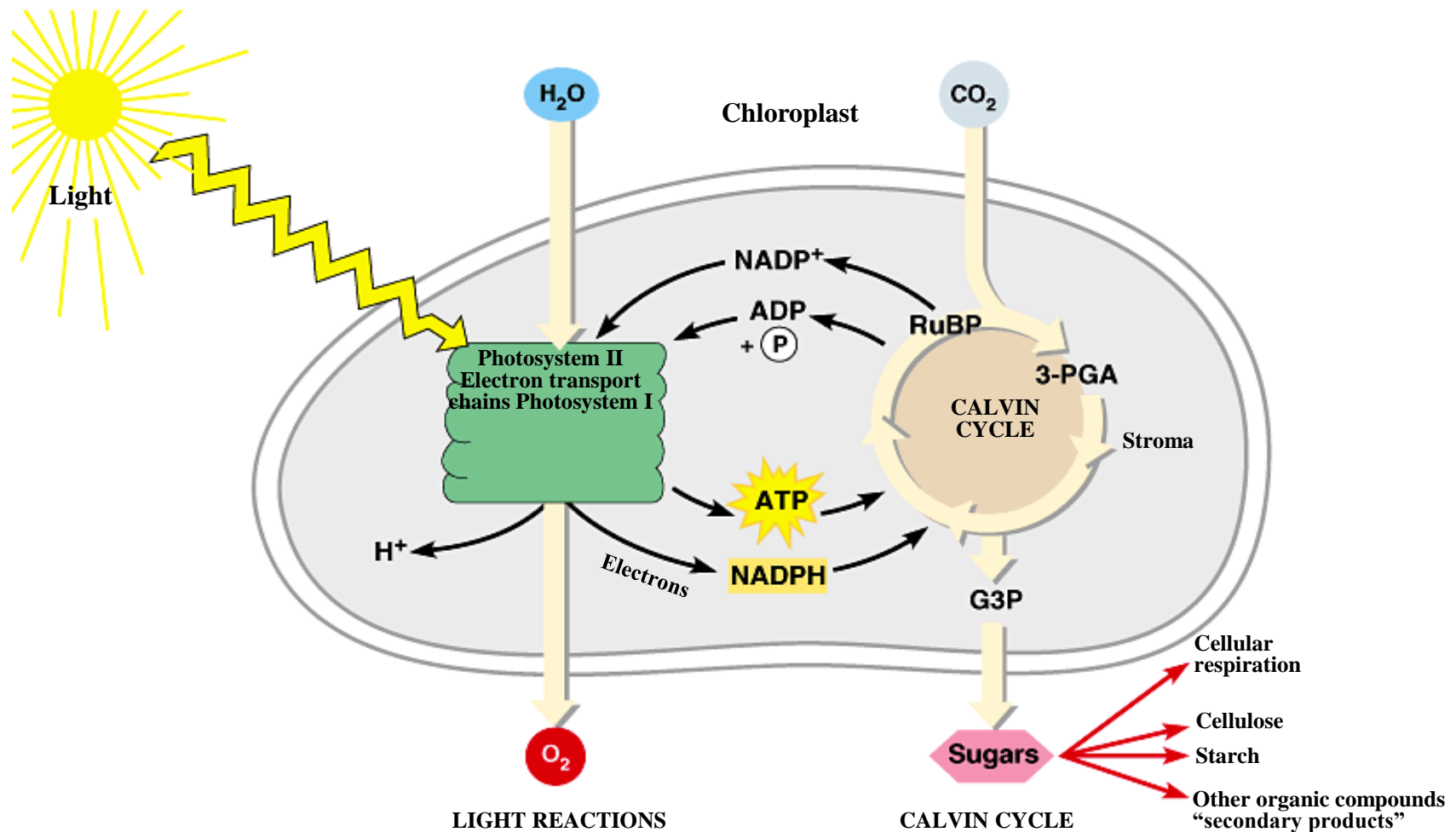

10. Biochemistry of Transition Metals

Photosynthesis: The Dark Reaction (Calvin-Cycle)

- Takes place in the stroma of the chloroplasts
- CO₂-fixation by
 - C₃-plants (90%)
Ribulose-1,5-biphosphate → 2 Glycerat-3-phosphate
 - C₄-plants, e.g. corn (2%)
Phosphoenolpyruvate → Oxalacetate
 - CAM-plants, e.g. succulents (8%)
Phosphoenolpyruvat → Oxalacetat
(CAM = Crassulacean Acid Metabolism)

Follows different biochemical synthesis routes!

10. Biochemistry of Transition Metals

Photosynthesis: The Dark Reaction (Calvin-Cycle)

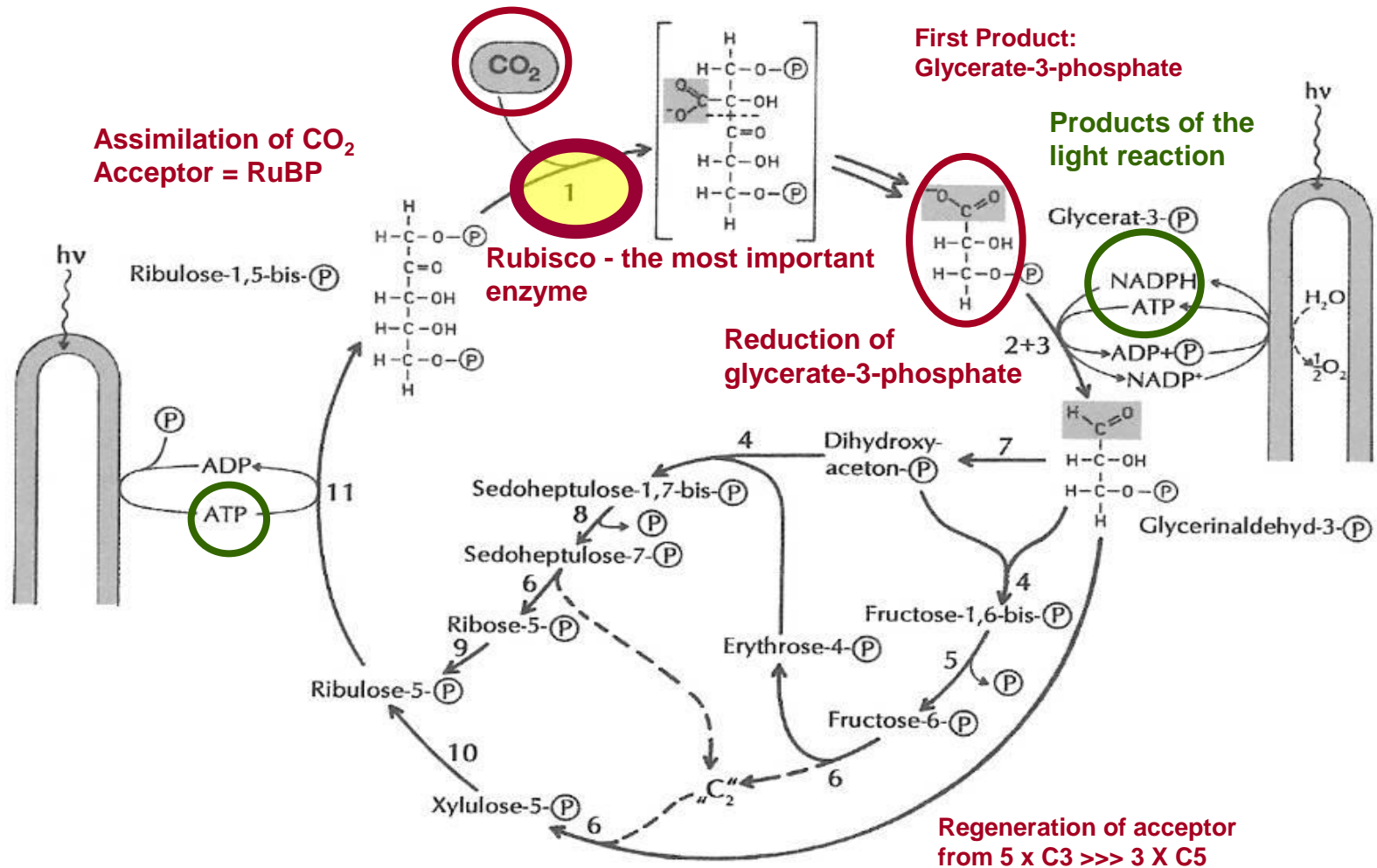

10. Biochemistry of Transition Metals

RuBisCo – The Most Important Enzyme

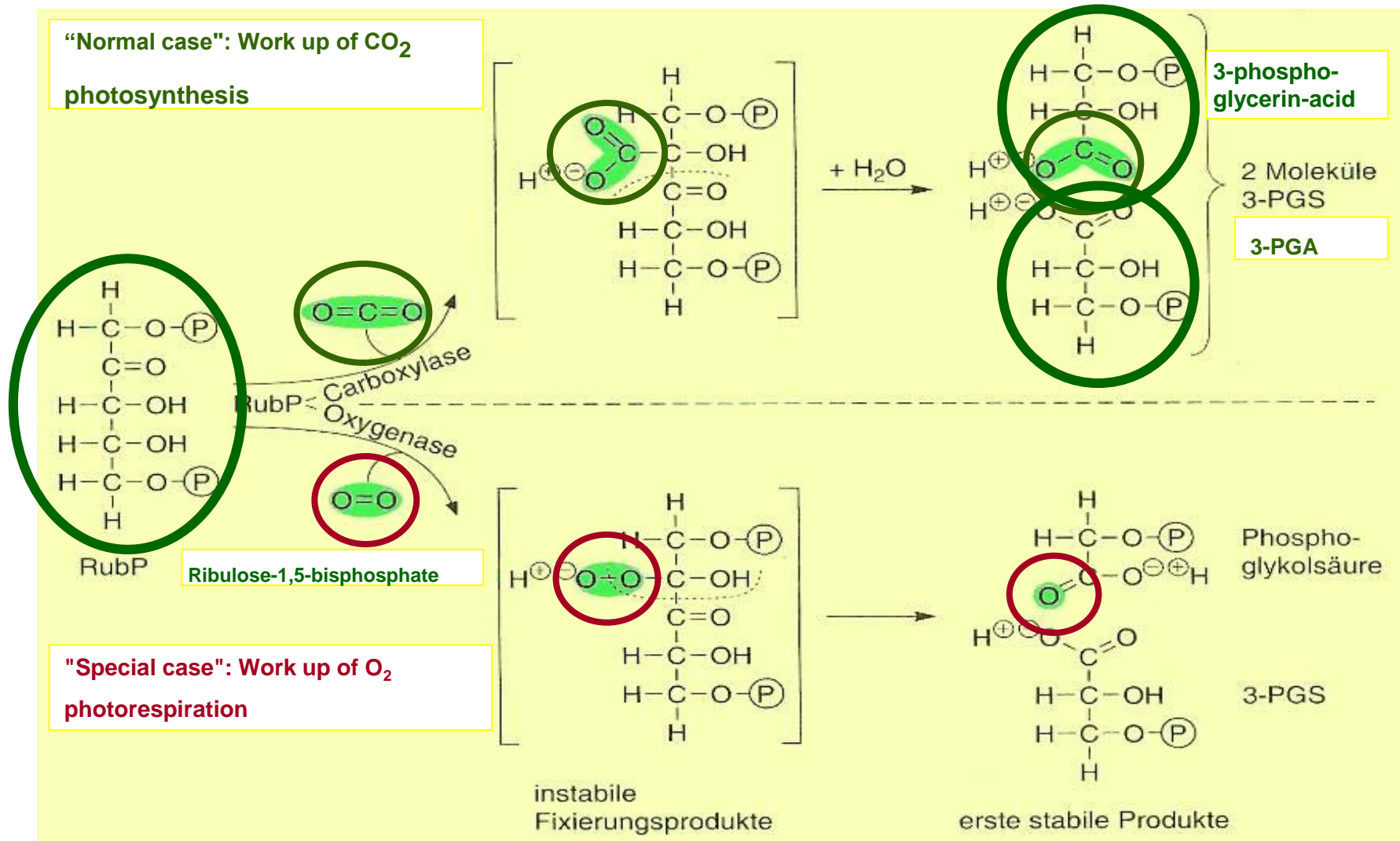

10. Biochemistry of Transition Metals

Photorespiration

- **RuBisCo catalyses two enzymatic reactions**
 - **Carboxylation**
 - **Addition of CO₂ to RuBP**
 - **Preferred under normal conditions**
 - **Photorespiration**
 - **Oxidation of RuBP by addition of O₂**
 - **Preferred when stoma is closed**
 - **Takes place when CO₂-partial pressure is low and that of O₂ is high**
- **CO₂ and O₂ compete for the binding to RuBP!**

10. Biochemistry of Transition Metals

The Iron Group

Iron

Fe^{2+}	$[\text{Ar}]3d^6$
Fe^{3+}	$[\text{Ar}]3d^5$
Fe^{4+}	$[\text{Ar}]3d^4$
Fe^{5+}	$[\text{Ar}]3d^3$
Fe^{6+}	$[\text{Ar}]3d^2$

moderately reductive agent

relatively redox stable but kinetically labile

$[\text{L}_2\text{Fe}_2(\text{cat})_2(\mu\text{-N})]^+$ are strong oxidising agents

$[\text{Fe}^{\text{III}}(\text{porphyrin})\text{N}_3] \rightarrow [\text{Fe}^{\text{V}}(\text{porphyrin})\text{N}] + \text{N}_2$

Na_2FeO_4 , K_2FeO_4 , BaFeO_4 are strong oxidising agents

$\text{Fe}^{3+} + 12 \text{H}_2\text{O} \rightleftharpoons \text{FeO}_4^{2-} + 8 \text{H}_3\text{O}^+ + 3 \text{e}^- \quad E^0 = +2.20 \text{ V}$

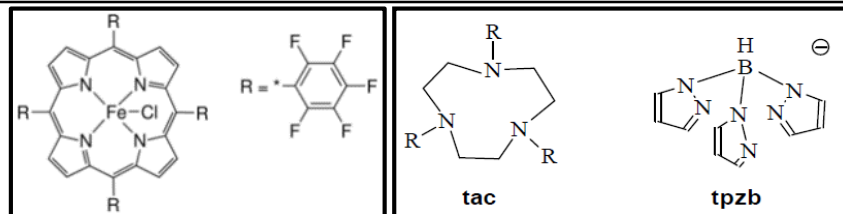

Ruthenium

Very scarce

Ru^{2+}	$[\text{Kr}]4d^6 \text{ l.s.}$
Ru^{3+}	$[\text{Kr}]4d^5 \text{ l.s.}$
Ru^{4+}	$[\text{Kr}]4d^4 \text{ l.s.}$
Ru^{8+}	$[\text{Kr}]$

Ruthenium(II)-complexes as antenna in Grätzel cells

Ruthenium(II/III)-complexes as cancerostatics

RuO_2

RuO_4 yellow, strongly oxidising

Osmium

Very scarce

Os^{8+}	$[\text{Xe}]4f^{14}$
------------------	----------------------

OsO_4 yellow, extremely toxic (oxidises 1,2-dioles)

10. Biochemistry of Transition Metals

The Iron Group

Bioinorganic Chemistry of Iron

Iron is essential for the oxygen transport and for many electron transfer reactions

Heme-protein (iron-porphyrin-complexes)

		<u>E^0 [V]</u>
• Hemoglobin	O_2 transport	0.17
• Myoglobin	O_2 storage	0.05
• Cytochrome (a,b,c)	Electron transfer	0.04 – 0.40
• Oxygenases	Oxygenation	
• Oxidases	O_2 reduction to O_2^- , O_2^{2-} , O^{2-}	
• Peroxidases	Oxidation with H_2O_2	
• Catalases	H_2O_2 disproportionation to H_2O and O_2	

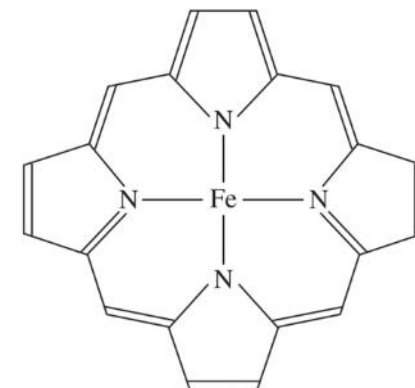

Aus "Allgemeine und Anorganische Chemie" (Birnswies, Jackel, Wölter, Rayner-Canham), erschienen bei Spektrum Akademischer Verlag, Heidelberg, © 2004 Elsevier GmbH München, Abbildung24-31.jpg

Non-heme-protein (iron-sulphur-cluster)

		<u>E^0 [V]</u>
• Rubridoxin	Electron transfer	-0.06
• Ferredoxin	Electron transfer	-0.42
• Nitrogenases	N_2 reduction to NH_3	
• Transferrin	Iron transport	
• Ferritin	Iron storage	

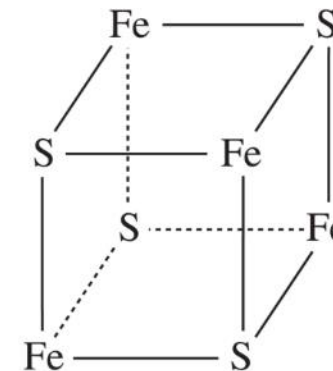

Aus "Allgemeine und Anorganische Chemie" (Birnswies, Jackel, Wölter, Rayner-Canham), erschienen bei Spektrum Akademischer Verlag, Heidelberg, © 2004 Elsevier GmbH München, Abbildung24-32.jpg

10. Biochemistry of Transition Metals

The Iron Group

Fe (and **Cu**): The basis of Oxygen transport proteins

Non-cellular

Chlorocruorine **Annelida** **18 kDa**

Erythrocrurine **Annelida, arthropoda** **several MDa**

Cellular

Hemerythrin **Annelida (sipunculidae)** **8 x 13-14 kDa**

Myoglobin **Vertebrata** **17 kDa**

Hemoglobin **Vertebrata** **65 kDa**

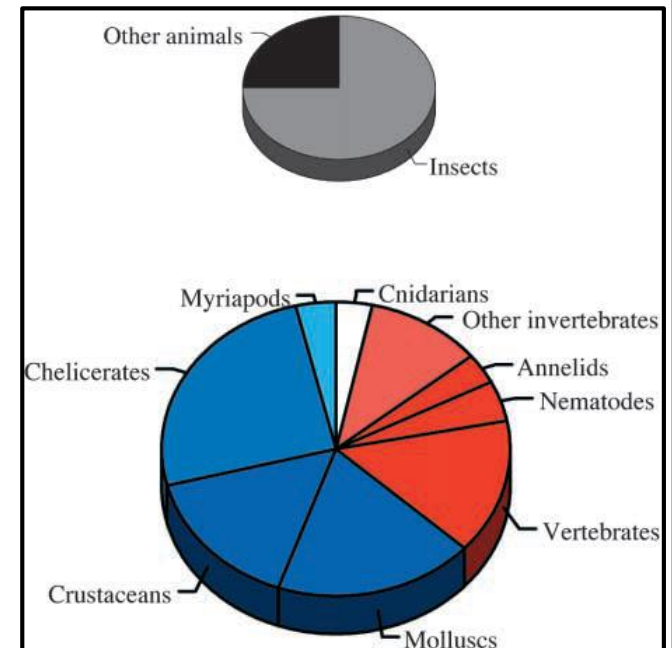
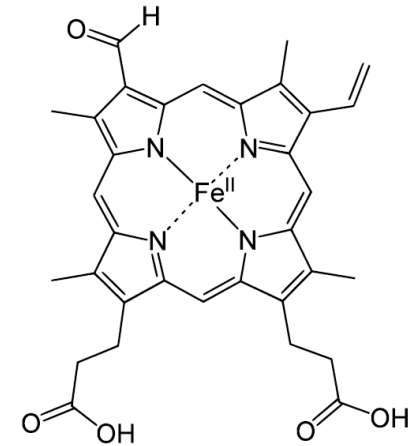

10. Biochemistry of Transition Metals

Fe-proteins: From Oxygen Transport to the Respiratory Chain

The adult human contains about 4 g Fe, with 75% thereof being bound in erythrocytes of the hemoglobin (as in other vertebrates)

Oxygen transport chain (lung - blood - tissue) → respiratory chain (mitochondria)
Fe-transport protein → **Fe-redox protein**

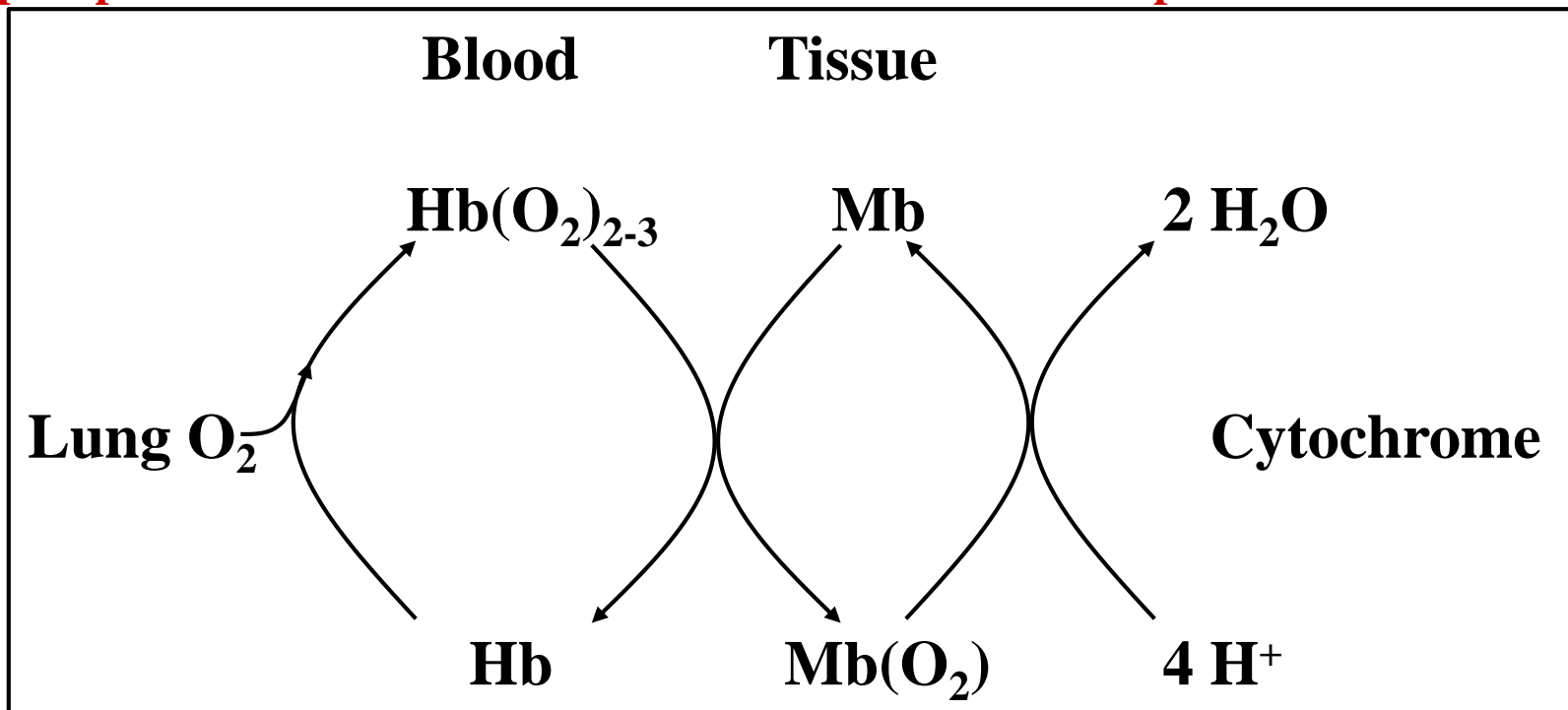

10. Biochemistry of Transition Metals

O₂-Transport-Fe-Proteins: Hemoglobin and Myoglobin

In vertebrates and some arthropods

Tetramers (Hb) and monomers (Mb)
with a single Fe²⁺ ion per moiety

Structure of myoglobin (Mb) and hemoglobin (Hb)

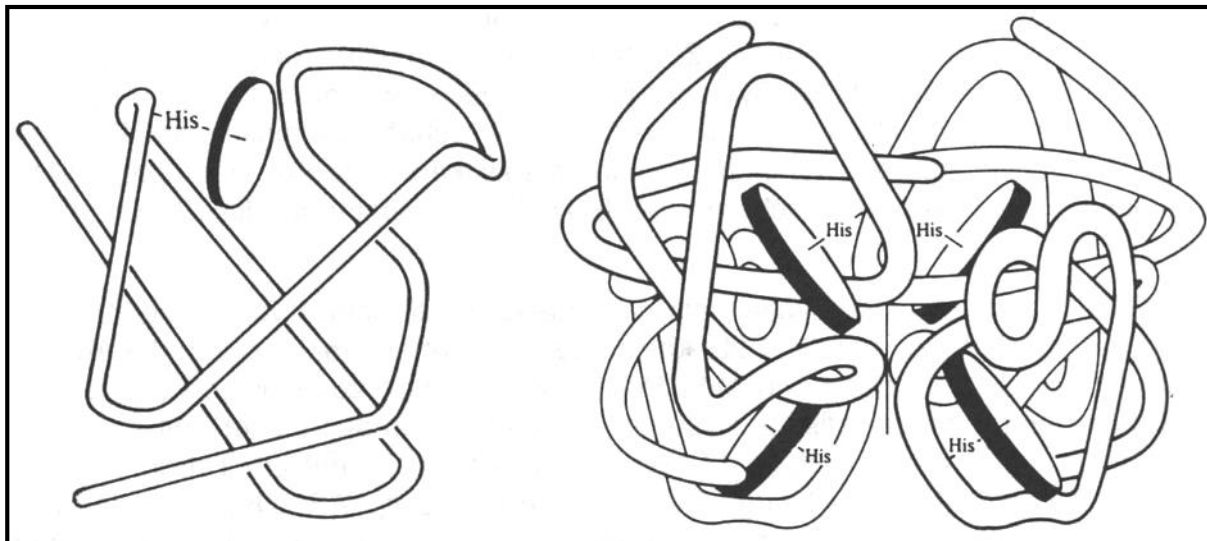

Erythrocytes ~ 3·10⁸
hemoglobin molecules



Sickle cell anaemia (gene defect)

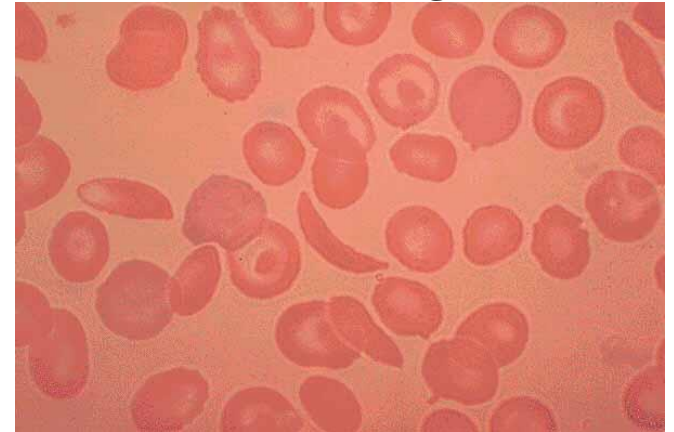

10. Biochemistry of Transition Metals

O₂-Transport-Fe-Proteins: Hemoglobin

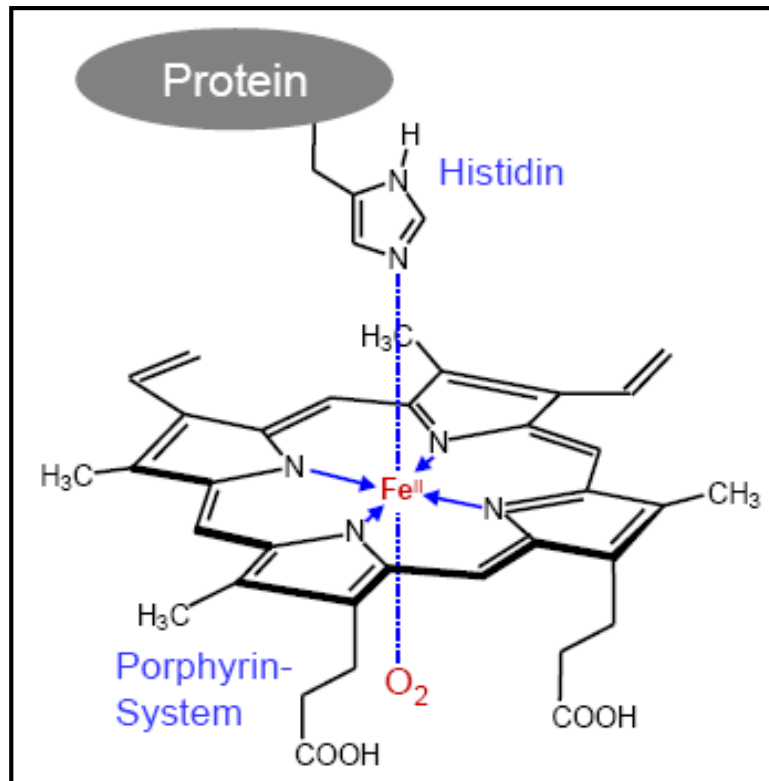
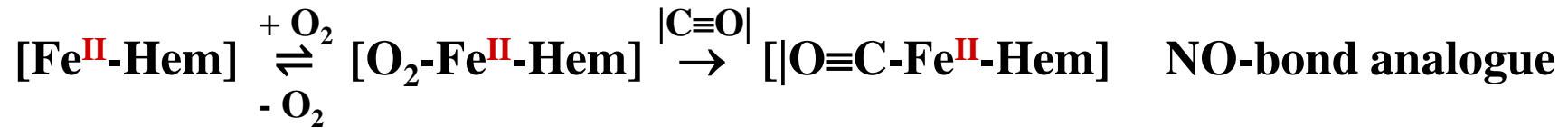

Hemoglobin is a tetramer (M = 65 kD)

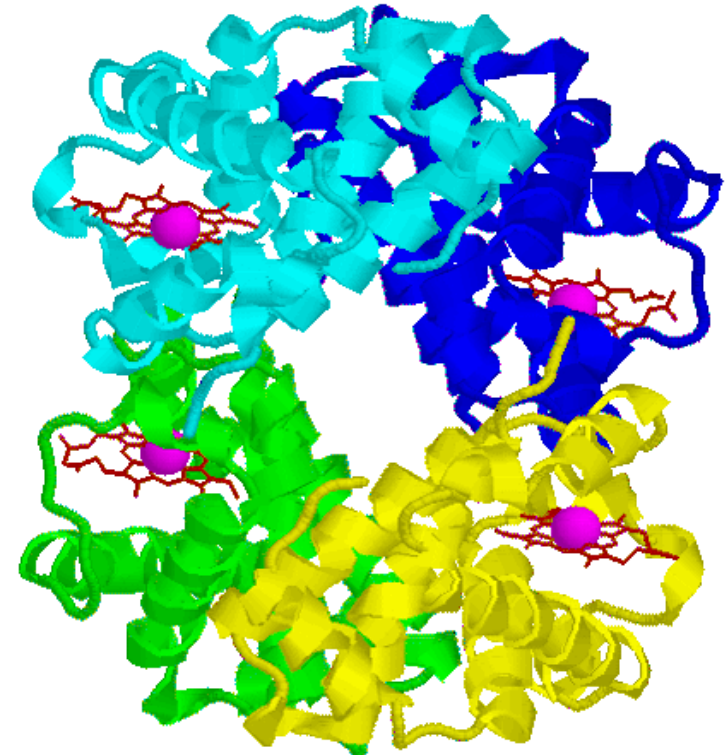

10. Biochemistry of Transition Metals

O₂-Transport-Fe-Proteins: Hemoglobin

Function and structure of heme

Oxyhemoglobin

Fe²⁺, [Ar]3d⁶ l.s., diamagnetic
r = 55 pm ⇒ in-plane structure

Desoxyhemoglobin

Fe²⁺, [Ar]3d⁶ h.s., paramagnetic
r = 78 pm ⇒ out-of-plane structure

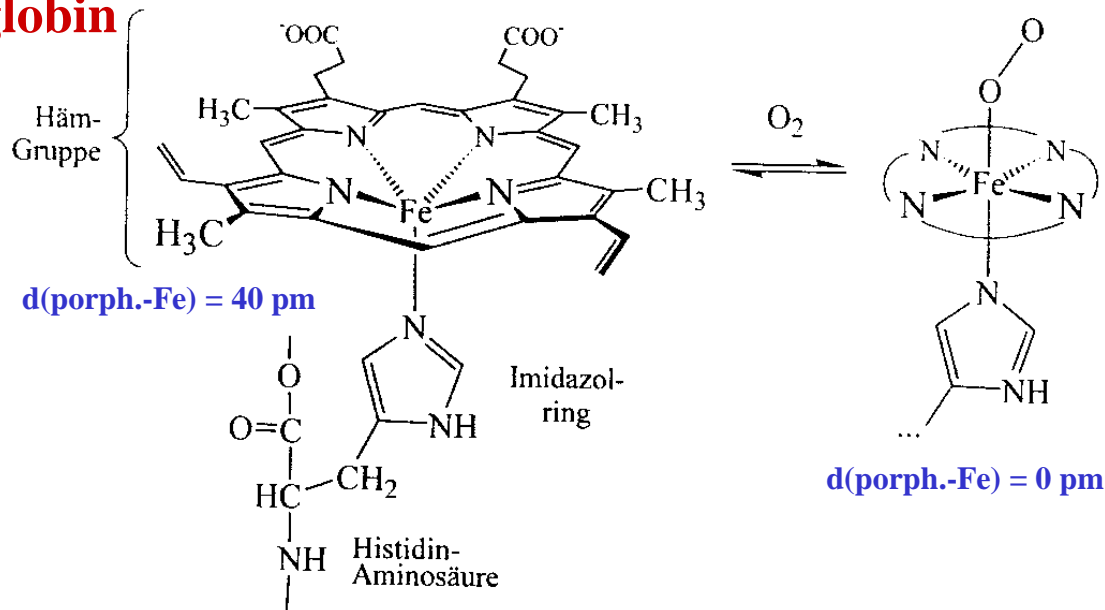

Free Fe²⁺

Fe²⁺ in desoxyhemoglobin

Fe²⁺ in oxyhemoglobin

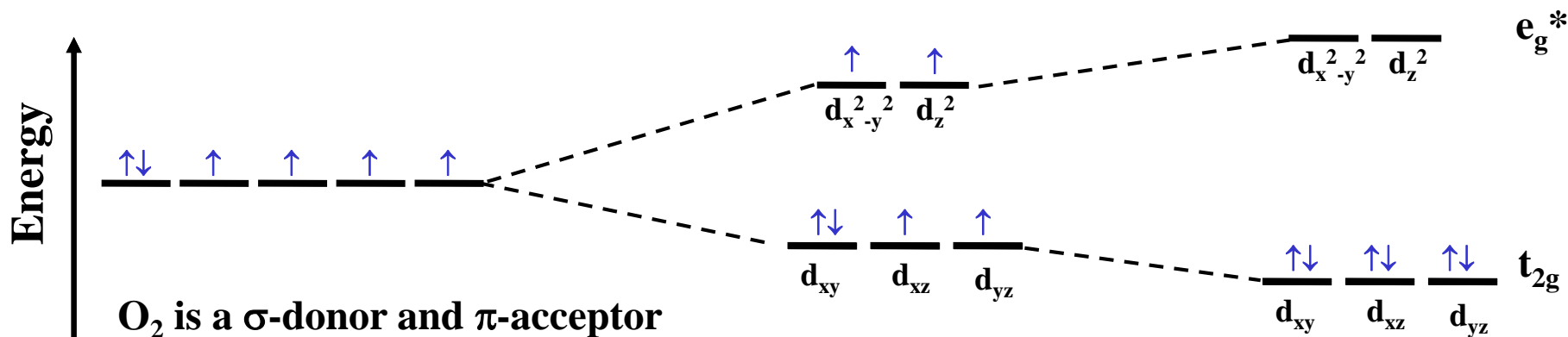

10. Biochemistry of Transition Metals

O₂-Transport-Fe-Proteins: Hemoglobin and Myoglobin – Oxygen Affinity

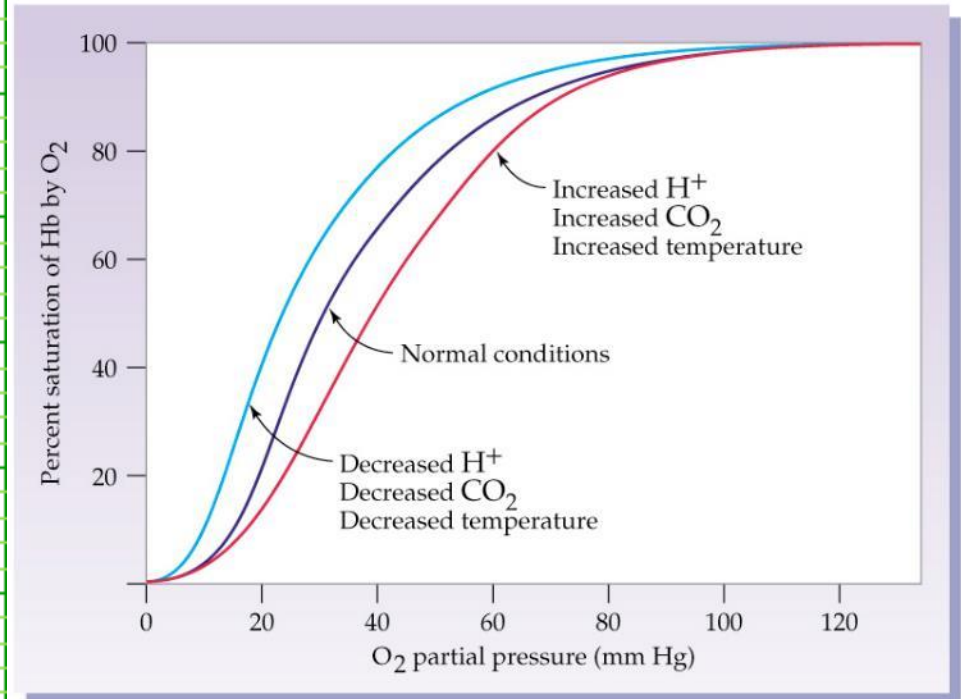
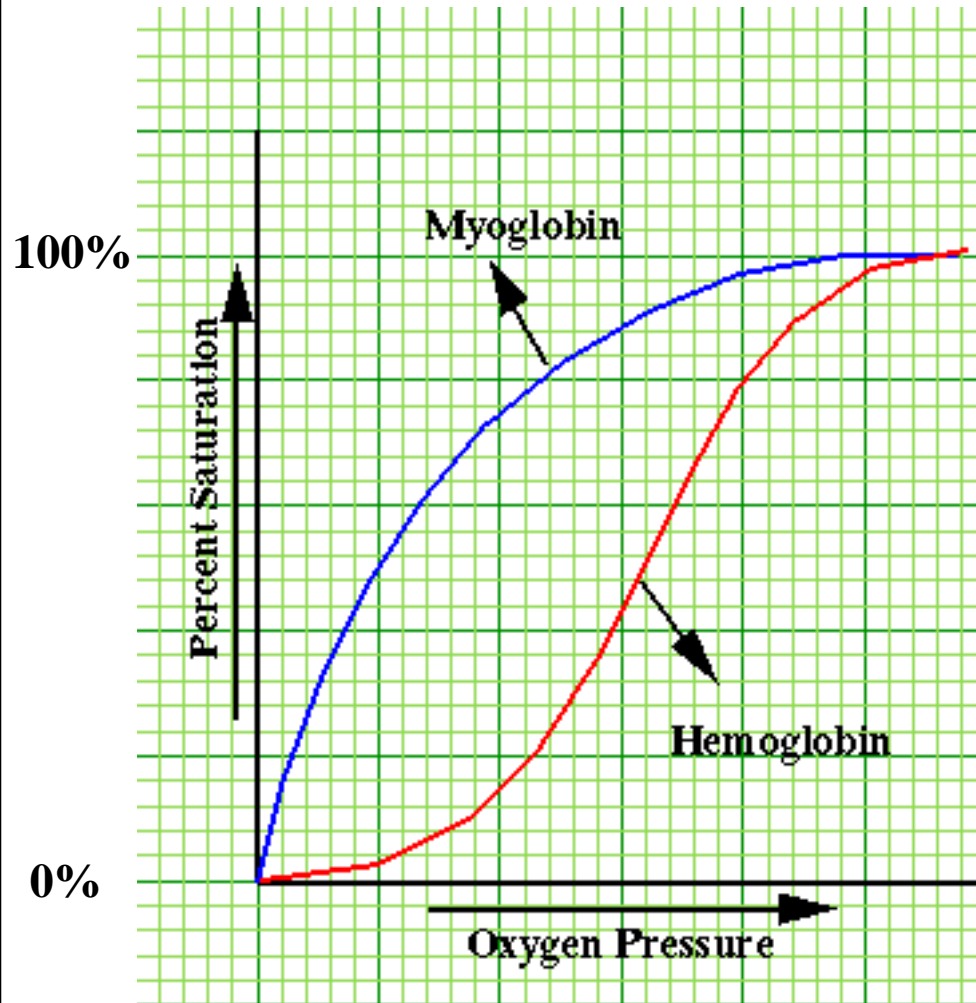

10. Biochemistry of Transition Metals

O₂-Transport-Fe-Proteins: Hemerythrin

In sipunculidae (marine worms)

Octamers with two Fe^{2+/3+} per sub-unit (D₄-symmetry)

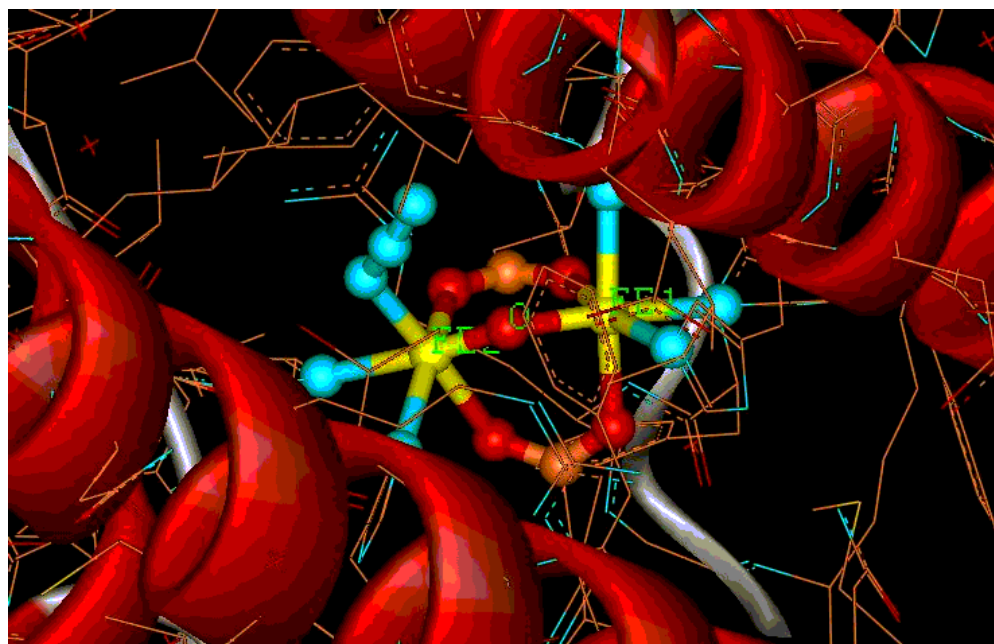

10. Biochemistry of Transition Metals

O₂-Transport-Fe-Proteins: Hemerythrin (Hy)

Structure of O₂-binding unit

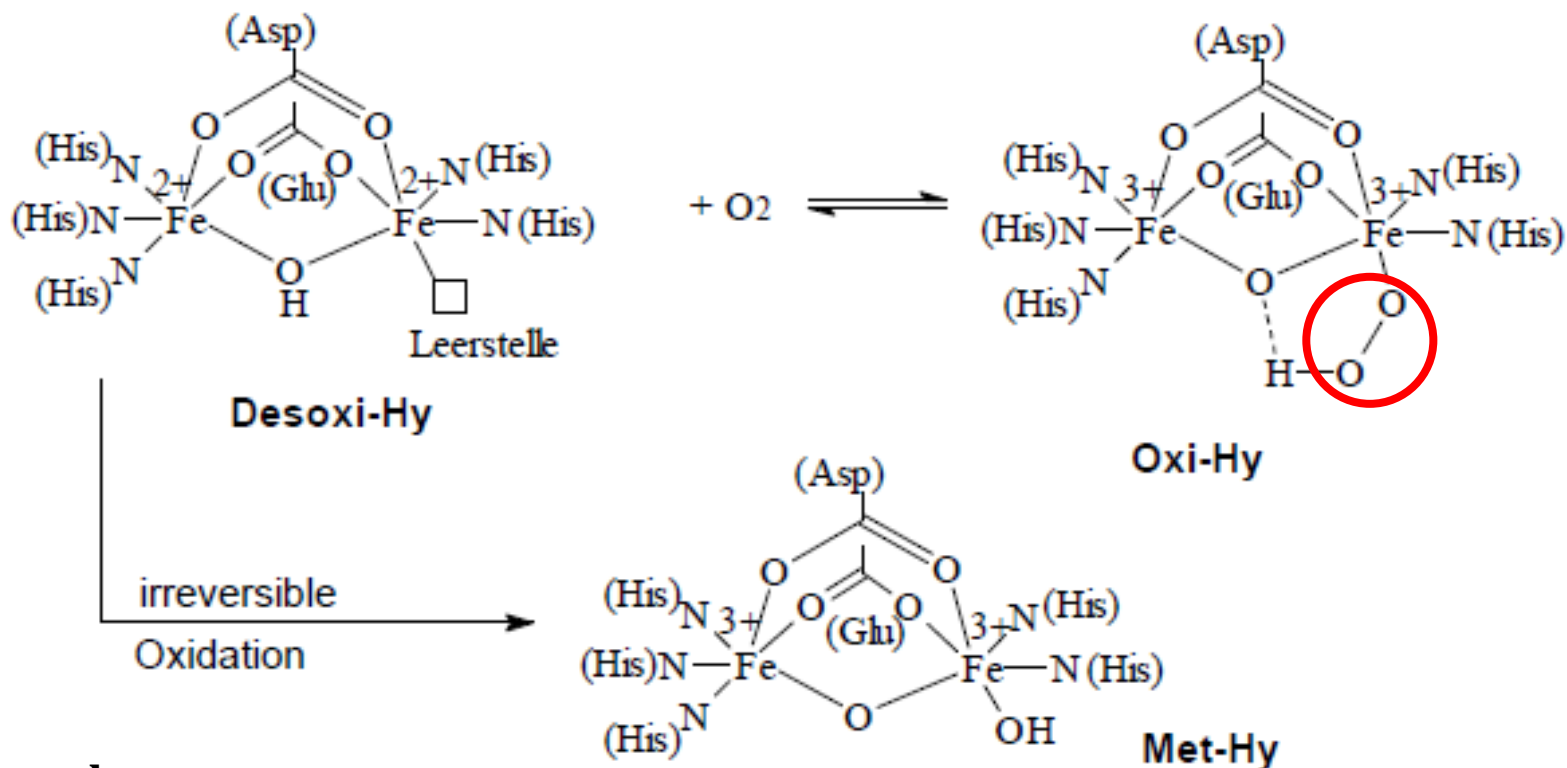

Modell complexes

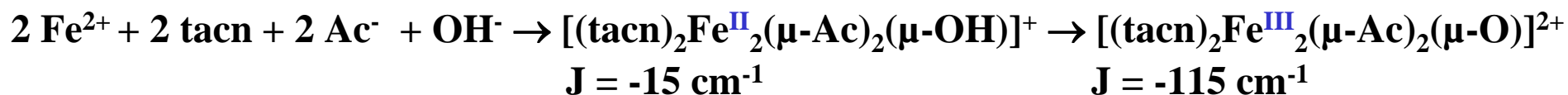

10. Biochemistry of Transition Metals

O₂-Transport-Fe-Proteins: Oxygen Reduction

Molecule	Bond order	d(O-O) [pm]	$\nu(\text{O-O})$ [cm ⁻¹]
O ₂ ⁺ (dioxygenyl cation)	2.5	112	1860
³ O ₂ (triplet-oxygen)	2.0	121	1555
O ₂ ⁻ (superoxide anion)	1.5	133	1145
O ₂ ²⁻ (peroxide anion)	1.0	149	770
Mb·O ₂ (oxygenated myoglobin)	~2.0	122	1107

Upon bonding of O₂ to Hb or Mb the O₂-bond is only slightly weakened, which means O₂ is not being reduced during its transport

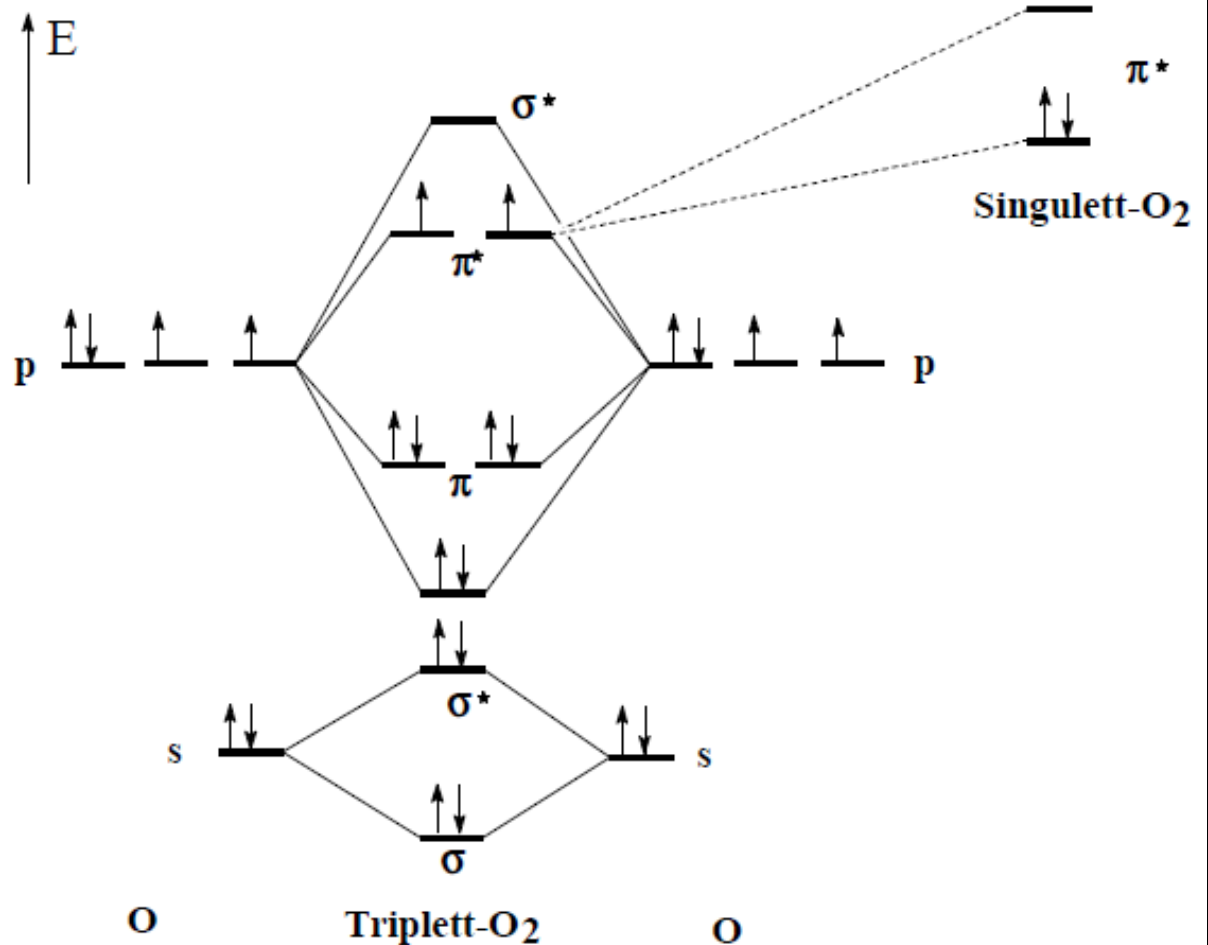

10. Biochemistry of Transition Metals

O₂-Transport-Fe-Proteins: Electronic configuration of Iron in haemoglobin (Hb) and oxidised haemoglobin (Hi)

Determination by Mössbauer
and EPR Spectroscopy with

S = Total spin

δ [mms⁻¹] = Isomerie shift

Δ [mms⁻¹] = Quadrupol splitting

Table 13.2 Mössbauer spectra for haemoglobin derivatives [10]

Compound*	S	T/K	Δ /(mm s ⁻¹)	δ (Fe) /(mm s ⁻¹)
HbCO	0	195	0.36	0.18
		4	0.36	0.26
Hb reduced	2	195	2.40	0.90
		4	2.40	0.91
HbNO	?	195–1.2	magnetically broadened	
HbO ₂	0	195	1.89	0.20
		77	2.19	0.26
		1.2	2.24	0.24
HiF	$\frac{5}{2}$	195–1.2	magnetically broadened	
HiH ₂ O	$\frac{5}{2}$	195	2.00	0.20
HiOH	$\frac{1}{2}$?	195	1.57	0.18
		77	1.9	0.2
HiN ₃	$\frac{1}{2}$	195	2.30	0.15
HiCN	$\frac{1}{2}$	195	1.39	0.17

* The abbreviation Hb is used for a Fe(II) haemoglobin compound and Hi for a Fe(III) haemoglobin compound.

10. Biochemistry of Transition Metals

Fe-Sulphur Proteins

Cluster with 1, 2, 3 or 4 iron atoms as well as cys- and/or his-ligands

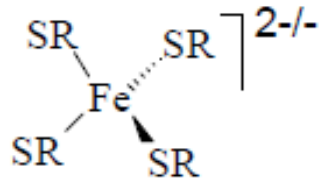

Rubredoxin

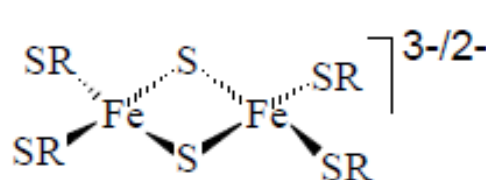

[2Fe-2S]-Ferredoxin

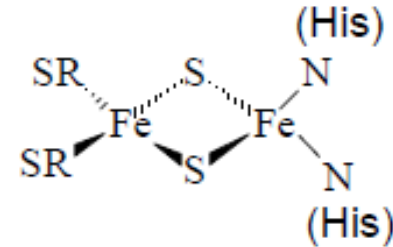

Rieske-Zentrum

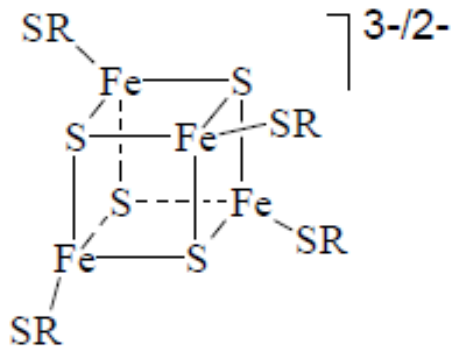

[4Fe-4S]-Ferredoxin

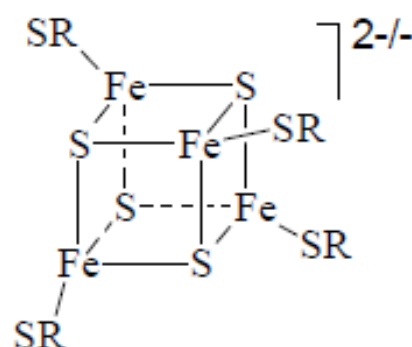

HiPIP

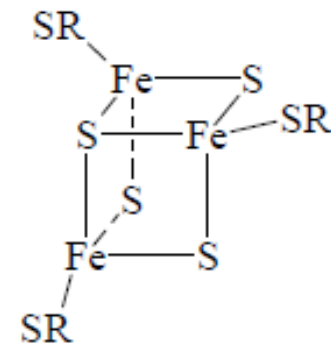

[3Fe-4S]-Ferredoxin

10. Biochemistry of Transition Metals

Fe-Redox Proteins: Mitochondrial Respiratory Chain



Mechanism of oxygen reduction in mitochondrial respiratory chain (5 steps)

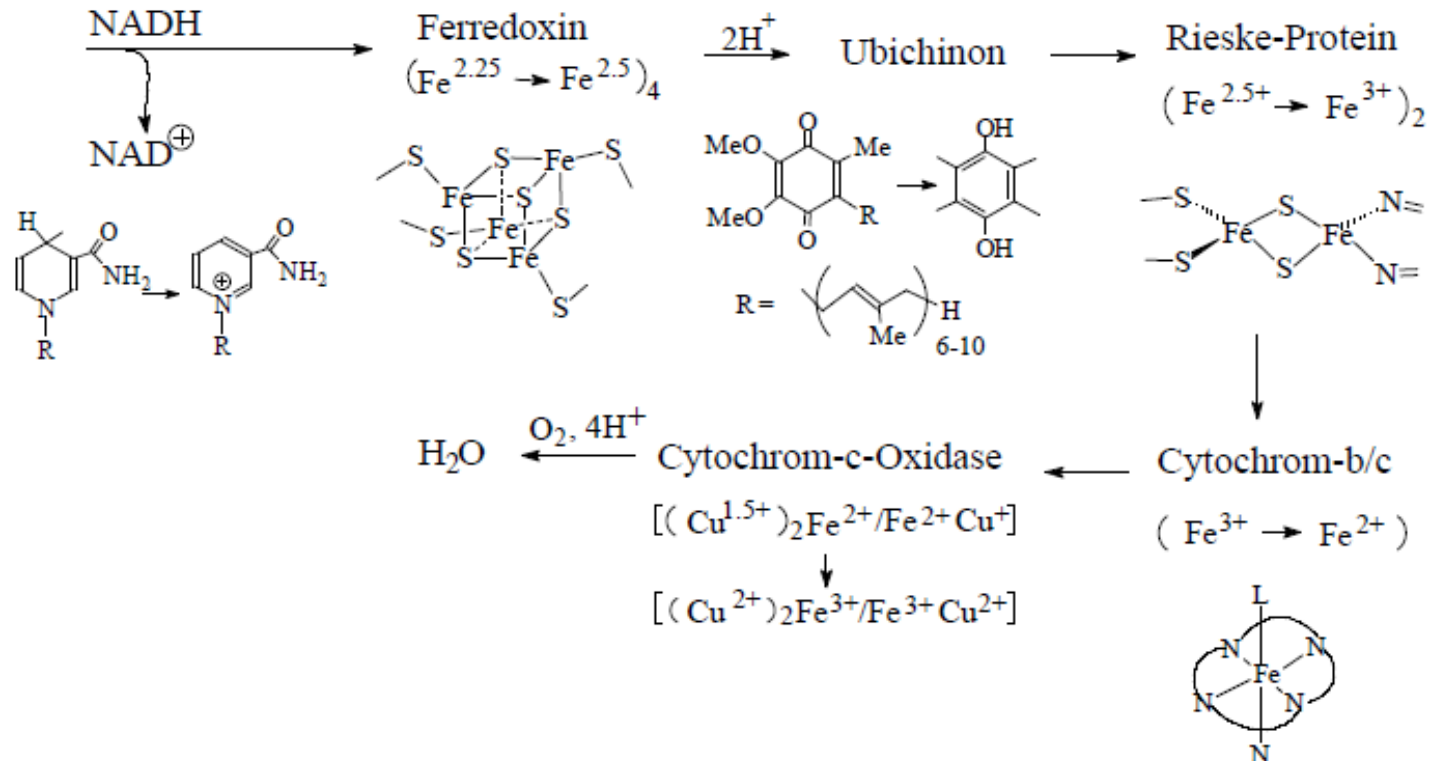

10. Biochemistry of Transition Metals

Fe-Redox Proteins: Mitochondrial Respiratory Chain

Location: Intermembrane space of eukaryotic mitochondria

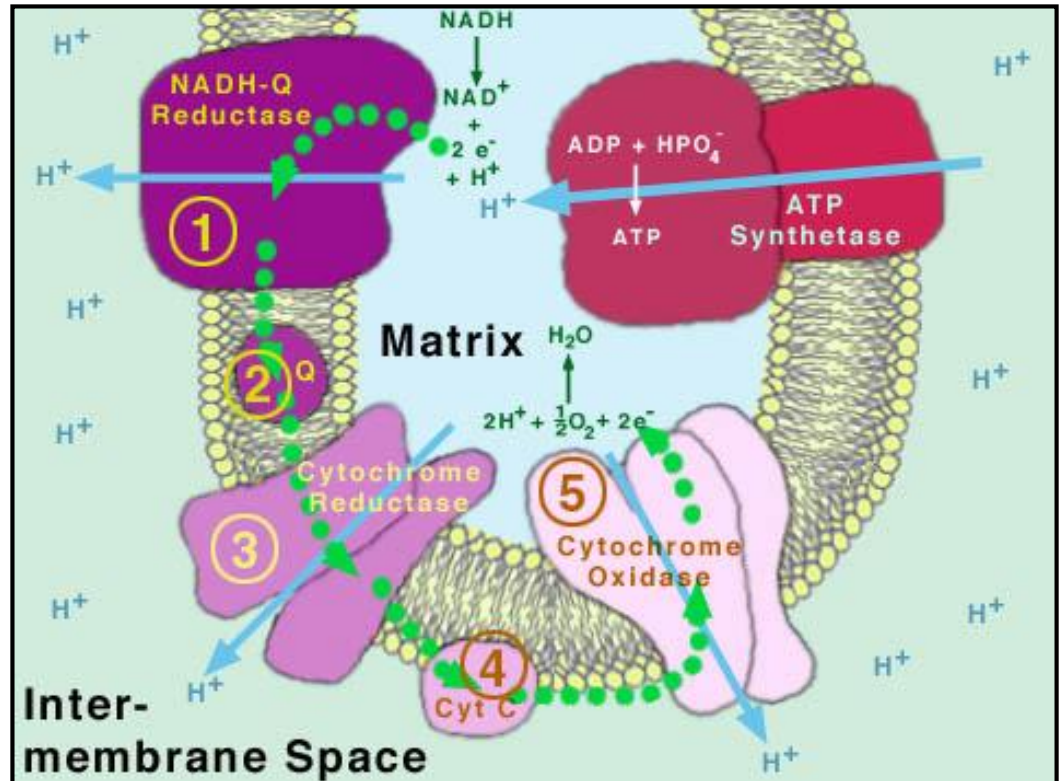
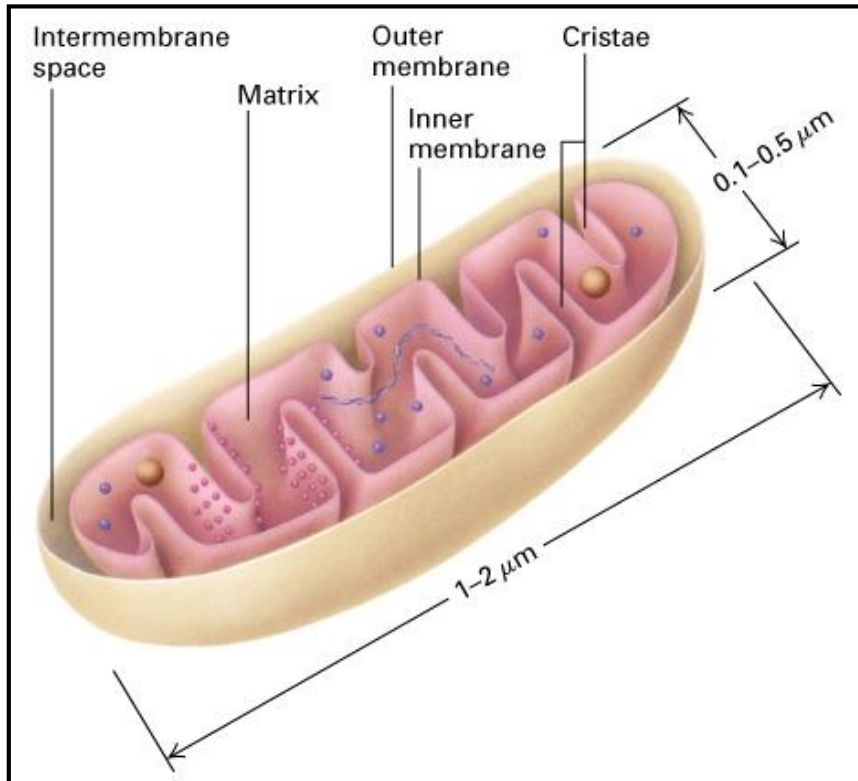

10. Biochemistry of Transition Metals

Fe-Redox Proteins: Mitochondrial Respiratory Chain

1st Step Transfer of reduction equivalents from **NADH** to a **ferredoxin**

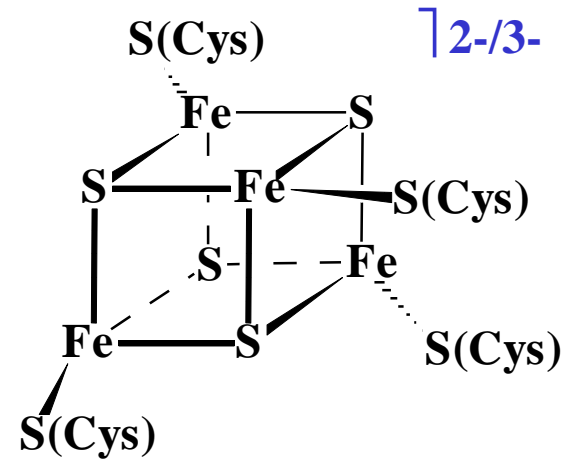
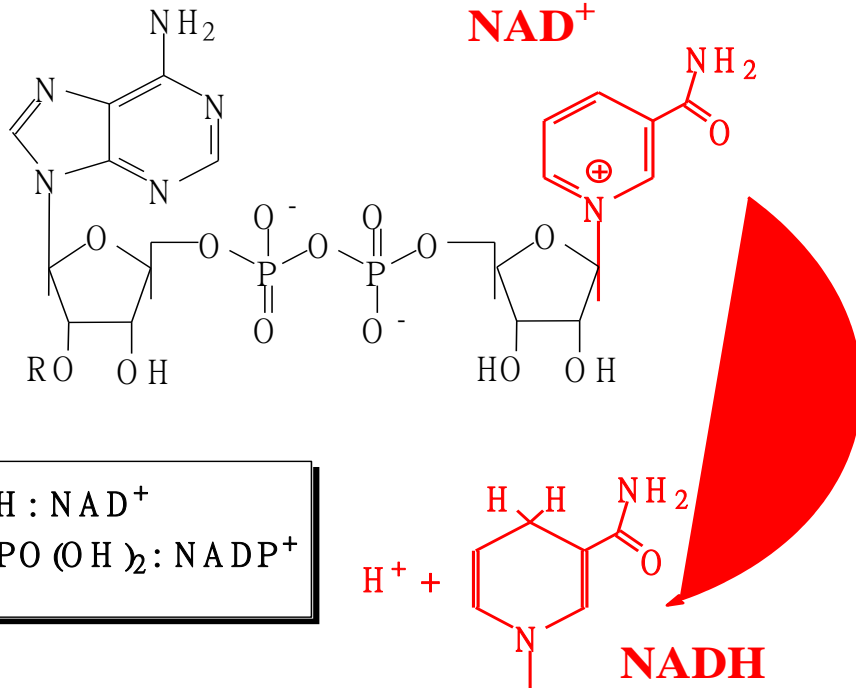
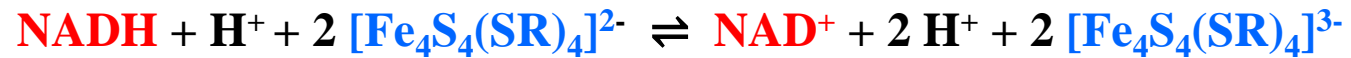

R = H : NAD⁺
R = PO(OH)₂ : NADP⁺

10. Biochemistry of Transition Metals

Fe-Redox Proteins: Mitochondrial Respiratory Chain

2nd Step Transfer of electrons to ubiquinone (Q, which is a quinone)

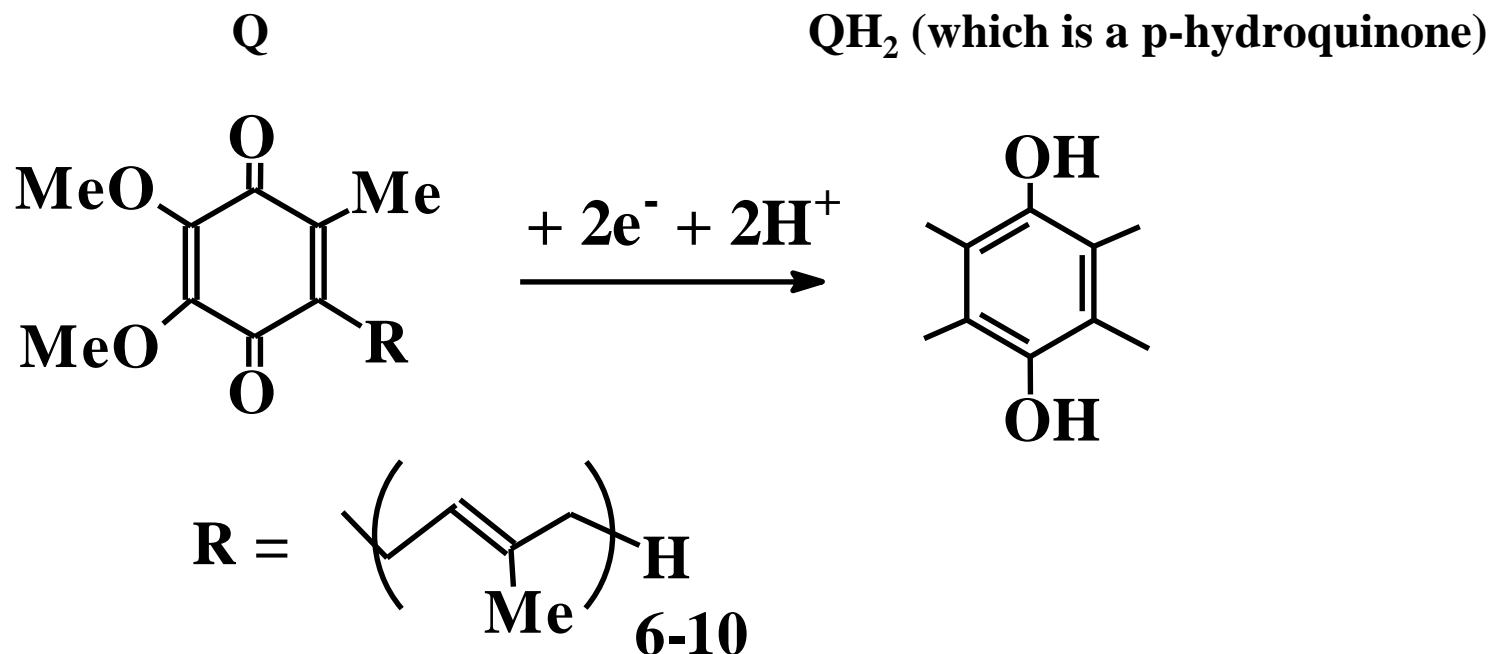

10. Biochemistry of Transition Metals

Fe-Redox Proteins: Mitochondrial Respiratory Chain

3rd Step Transfer of electrons from ubihydroquinone to a **Rieske-protein**

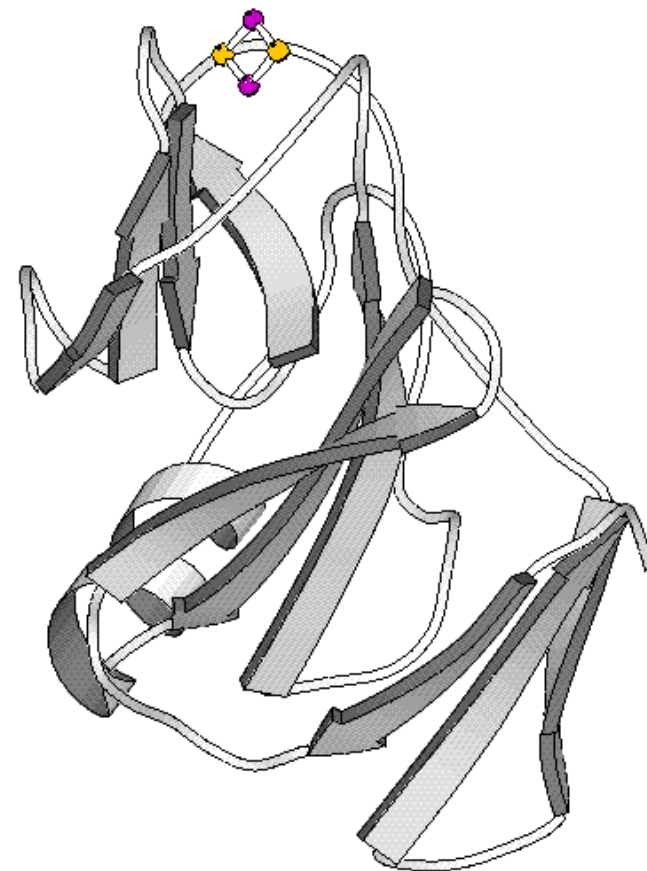
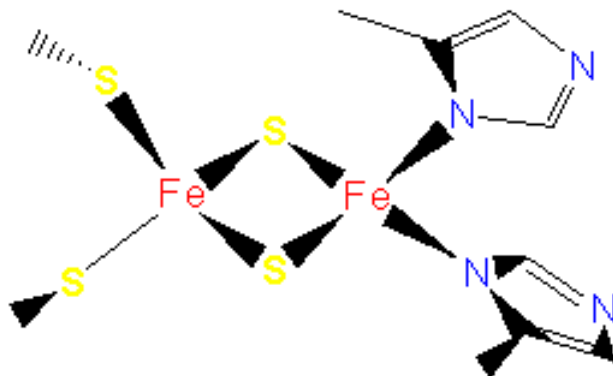

10. Biochemistry of Transition Metals

Fe-Redox Proteins: Mitochondrial Respiratory Chain

4th Step Transfer of electrons from Rieske-protein to cytochrome-b and -c

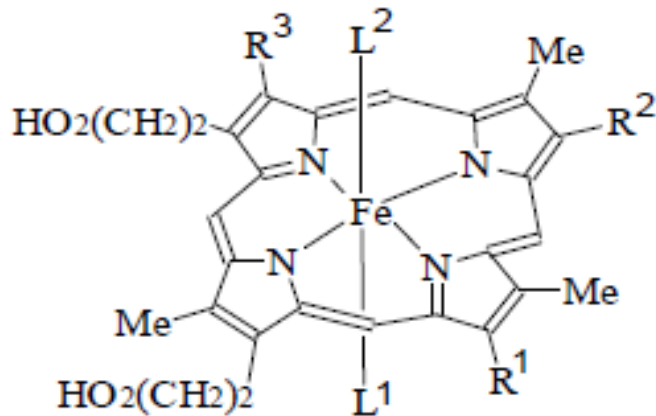
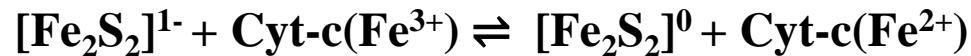

Cytochrom a: $R^1 = \text{Vinyl}$, $R^2 = \text{C}_{17}\text{H}_{34}\text{OH}$, $R^3 = \text{Formyl}$

$L^1 = L^2 = \text{His}$

Cytochrom b: $R^1 = R^2 = \text{Vinyl}$, $R^3 = \text{Me}$

L^1 und L^2 frei oder His

Cytochrom c: $R^1 = R^2 = -\text{CH}(\text{Me})-\text{S}-\text{CH}_2-\text{C}(\text{O})\text{NH}-$

$R^3 = ; L^1 = \text{His}, L^2 = \text{Met}$

Cytochrom P_{450} : $R^1 = R^2 = \text{Vinyl}$, $R^3 = \text{Me}$

$L^1 = \text{Cys}, L^2 = \text{H}_2\text{O}$

10. Biochemistry of Transition Metals

Fe-Redox Proteins: Mitochondrial Respiratory Chain

5th Step Transfer of electrons from cytochrome-c to cytochrome-c-oxidase and reduction of oxygen to water (using proton pumps)

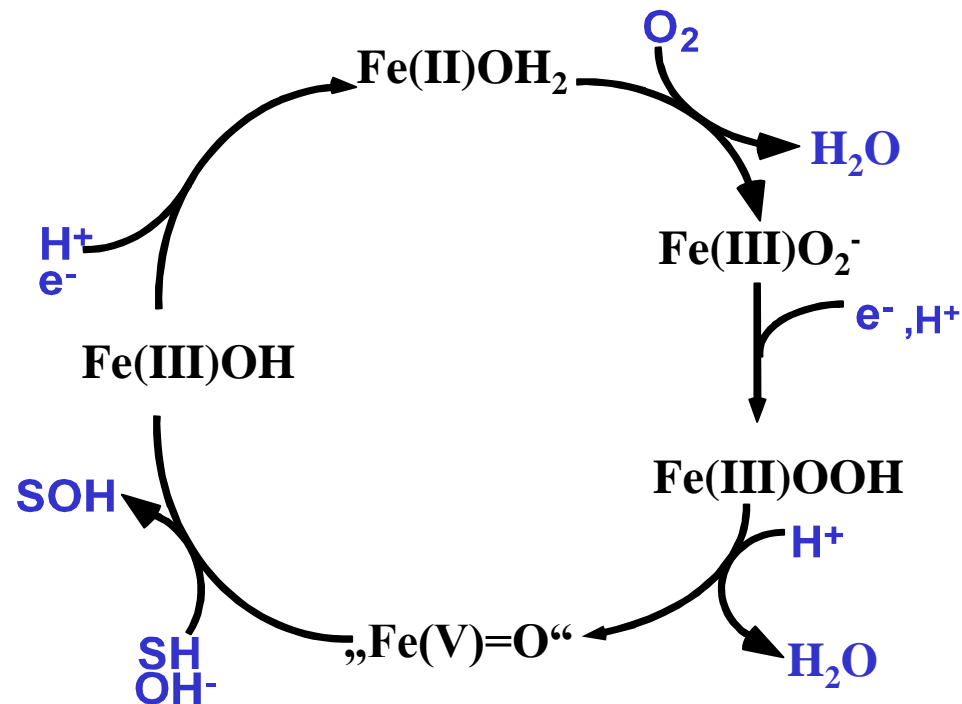
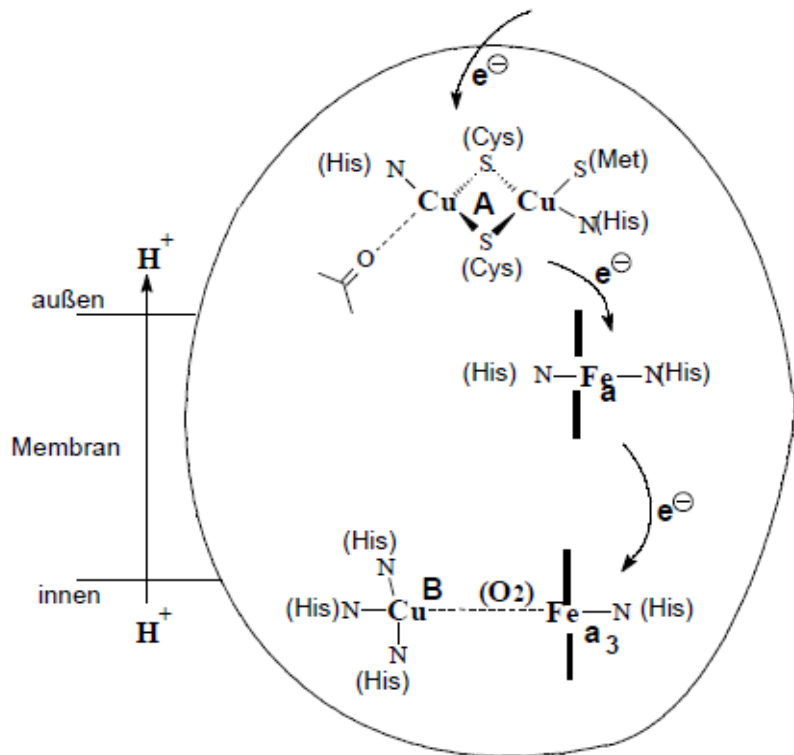
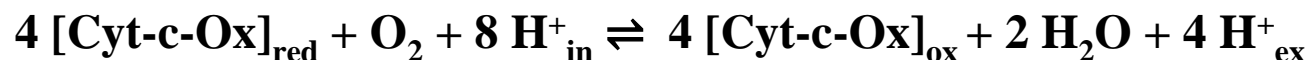

10. Biochemistry of Transition Metals

Fe-Biomineralisation and Fe-Storage

Formation of mineralised Fe-salts by living creatures

- $\alpha\text{-FeO(OH)}$ Goethite limpets (radula)
- Fe_3O_4 Magnetite magnetotactic bacteria
- Fe_3S_4 Greigite magnetotactic bacteria
- FeS_2 Pyrite sulphate reducing bacteria

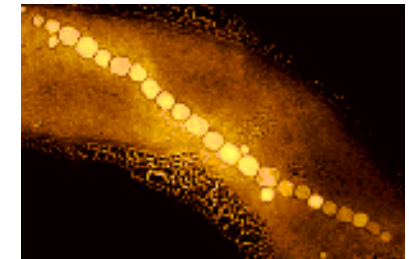
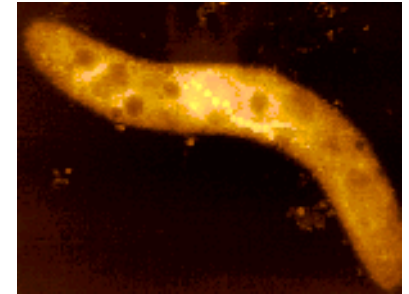

Ferritins contain goethite-like material of the following composition

“ $8 \text{FeO(OH)} \cdot \text{FeO(H}_2\text{PO}_4)$ ”

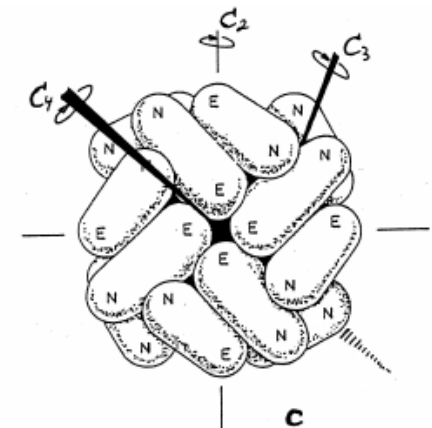
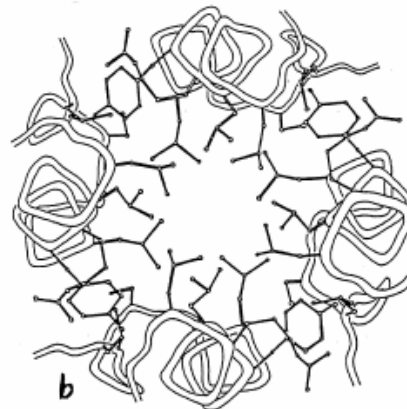

10. Biochemistry of Transition Metals

Fe-Transport: Siderophores

Siderophores are released by many micro organisms and plants into their surrounding aqueous medium in order to mobilise Fe^{3+} by complexation from poorly soluble iron hydroxide deposits in soil

Ligands (log K ~ 20 ... 50)

- Hydroxamates

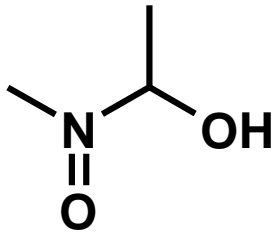

- Catecholates

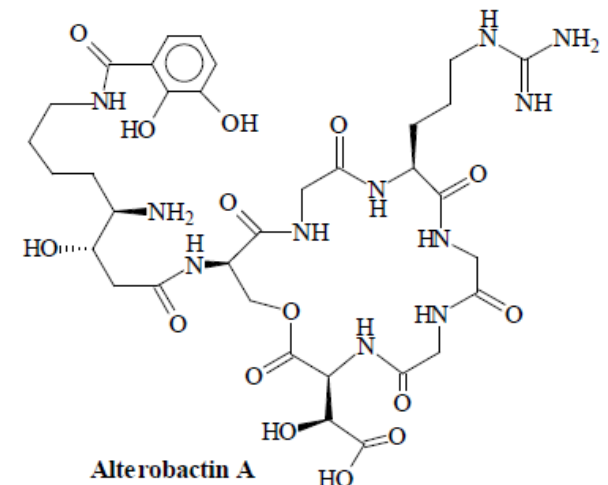
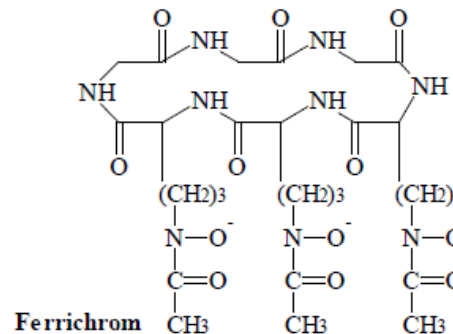
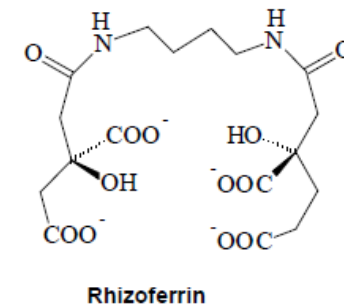
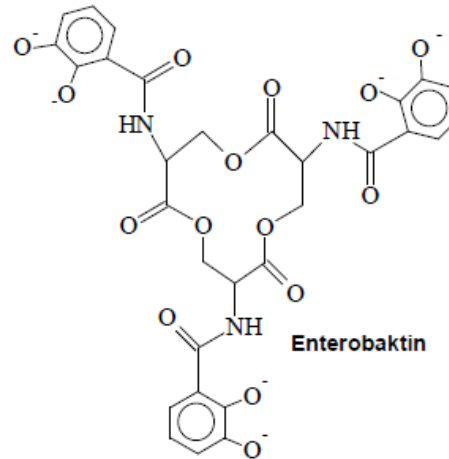
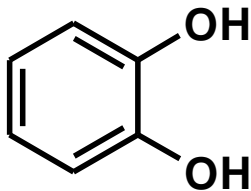

10. Biochemistry of Transition Metals

Fe-Transport: Siderophores

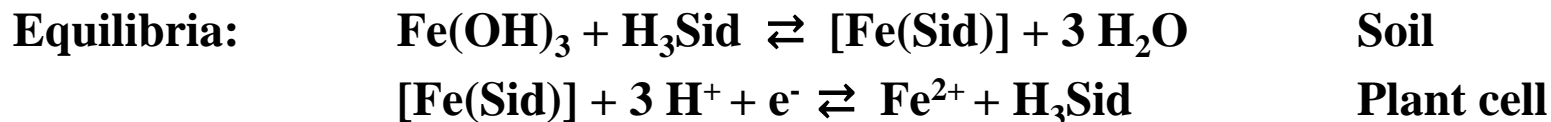

Siderophor	Log K	E^0 [V] at pH 7	Ligand type
Mugenein acid	18.1	-0.102	Carboxylate, Amino-N
Aerobactin	22.5	-0.336	Hydroxamate, Carboxylate
Coprogen	30.2	-0.447	Hydroxamate
Deferrioxamin B	30.5	-0.468	Hydroxamate
Ferrichrom A	32.0	-0.448	Hydroxamate
Enterobactin	~ 49	-0.790	Catecholate
Alterobactin A	~ 51	-0.972	Catecholate
			Hydroxo
			Carboxylate

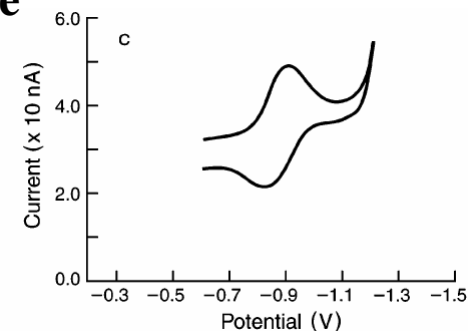

→ Analytical method: Cyclic Voltammetry (CV), which deliver voltage-current diagrams

10. Biochemistry of Transition Metals

The Cobalt Group

Cobalt

Co^+	$[\text{Ar}]3\text{d}^8$	strong reducing agent, high-spin or low-spin
Co^{2+}	$[\text{Ar}]3\text{d}^7$	weak reducing agent, high-spin or low-spin
Co^{3+}	$[\text{Ar}]3\text{d}^6$ l.s.	relatively redox stable, very high kinetic stability, l.s.-complexes, except $[\text{CoF}_6]^{3-}$

Rhodium

Extremely scarce

Rh^{2+}	$[\text{Kr}]4\text{d}^7$ l.s.	
Rh^{3+}	$[\text{Kr}]4\text{d}^6$ l.s.	$[\text{Rh}(\text{bqdi})(\text{NH}_3)_4]^{3+}$ bind to DNA and are able to cleave it through photo activation (with bqdi = benzoquinone diimine or other diimines)

Iridium

Extremely scarce

Ir^{3+}	$[\text{Xe}]4\text{f}^{14}5\text{d}^6$ l.s.	Ir^{3+} -complexes are kinetically extremely stable (OLEDs)
Ir^{4+}	$[\text{Xe}]4\text{f}^{14}5\text{d}^5$ l.s.	IrO_2

10. Biochemistry of Transition Metals

Cobalt Proteins

The adult human contains ~ 2.5 mg of cobalt, primarily bound in the macrocycle complex called cobalamin (vitamin B₁₂). The macrocycle ligand is a corrin ring

Alkyl cobalamins take part in redox reactions, alkylations and rearrangements. Co^{III}-, Co^{II}- and Co^I-species may participate in 1-electron reductions and oxidations

Methylations (even of Hg²⁺):

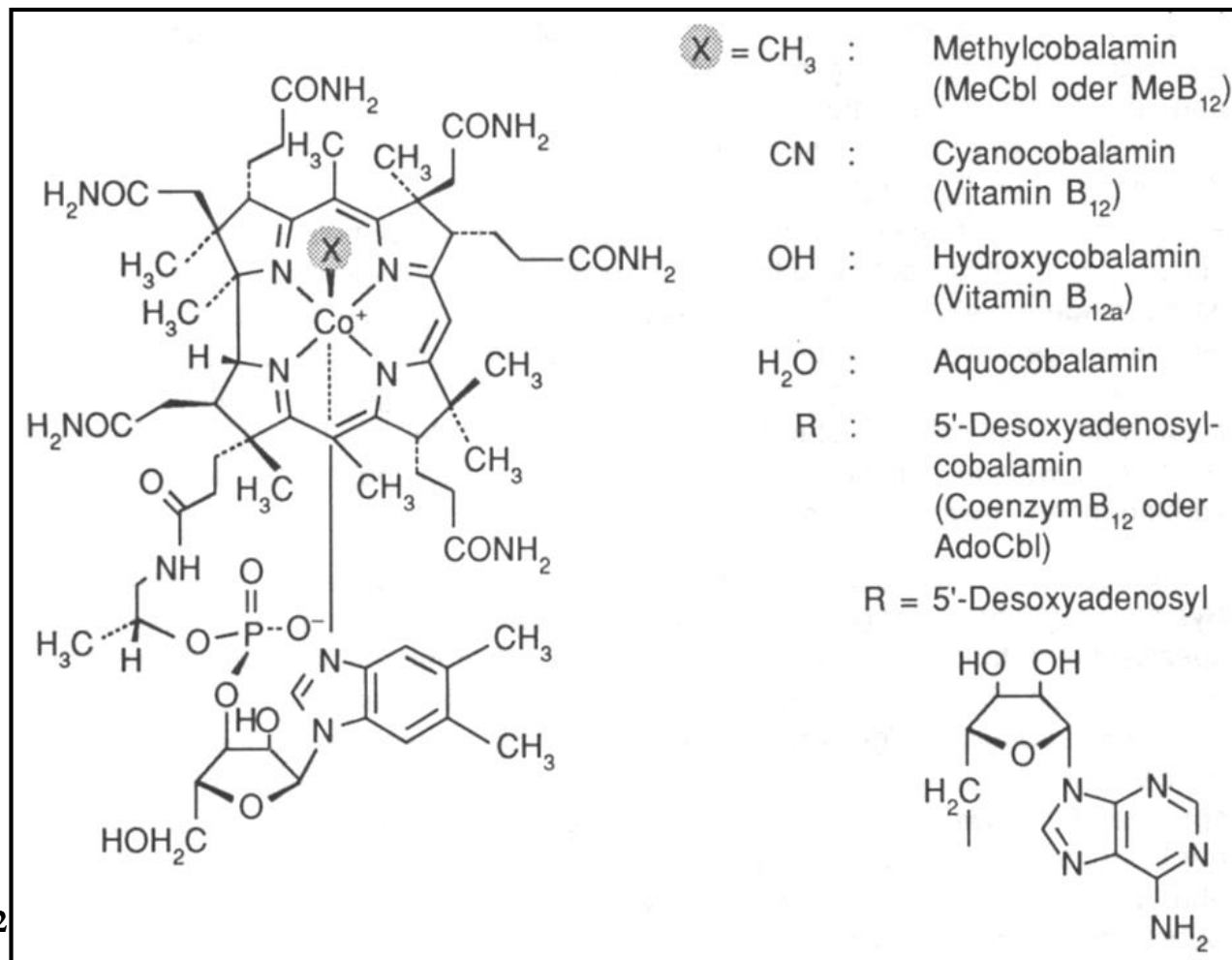
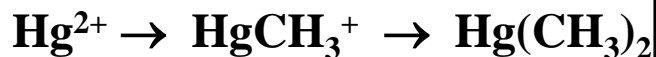

10. Biochemistry of Transition Metals

Cobalamin: Some Facts

- **Cobalt is the most scarce element of the 3d-series, that means it is a trace element (Mn: 1060 ppm; Fe: 62000 ppm; Co: 29 ppm; Ni: 99 ppm; Cu: 68 ppm). Obviously, Co has been “chosen” due to a specific functionality**
- **The corrin ring (15 atoms) is smaller as the porphyrin ring (16 atoms, i.e. there is one CH₂-unit less in the ring). Co-porphyrin complexes are thus no model complexes for cobalamines. The bonding plane is distorted planar.**
- **The only known stable metal-organic compound in living creatures is the coenzyme MeB₁₂, with MeB₁₂ being stable in water**
- **Vitamin B₁₂ was discovered as treatment for pernicious anaemia in the 20's of the 20th century. In the beginning, essences of animal liver was used, which core part is made up of cobalt**
- **Not until 1948, the synthesis of cyanocobalamin = vitamin B₁₂ was successful (does not occur naturally in the body but exhibits therapeutic properties)**
- **Coenzyme B₁₂ is produced by animals and is stored in the liver**
- **The structure of vitamin B₁₂ and shortly after that of coenzyme B₁₂ was discovered by Dorothy Crowfoot-Hodgkins (Nobel price 1964)**

10. Biochemistry of Transition Metals

Cobalamin: Crystal Field Splitting in Co^{3+} -Complexes $[\text{Ar}]3d^6$

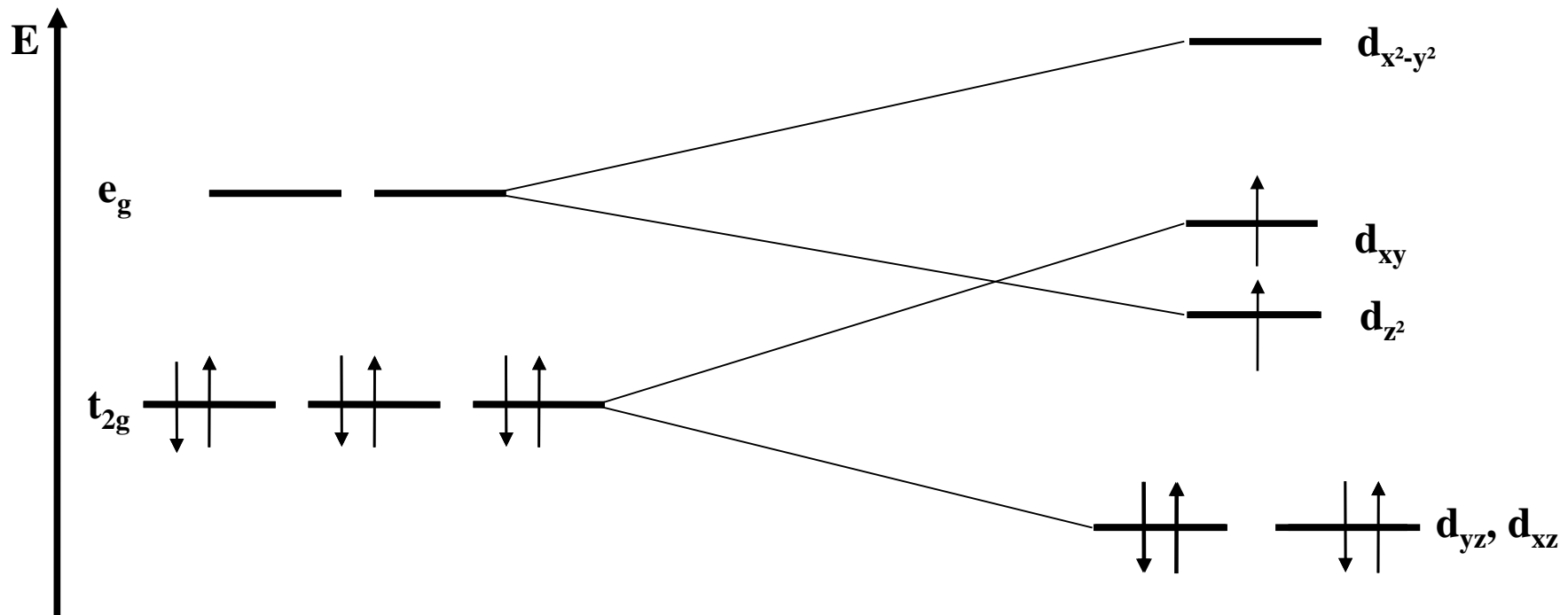

**Octahedral
diamagnetic**

CFSE = $-24 Dq(\text{octahedral})$

**Square-planar
paramagnetic**

1- and 2-electron reduction feasible

10. Biochemistry of Transition Metals

Cobalamin: One-Electron-Reduction and One-Electron-Oxidation

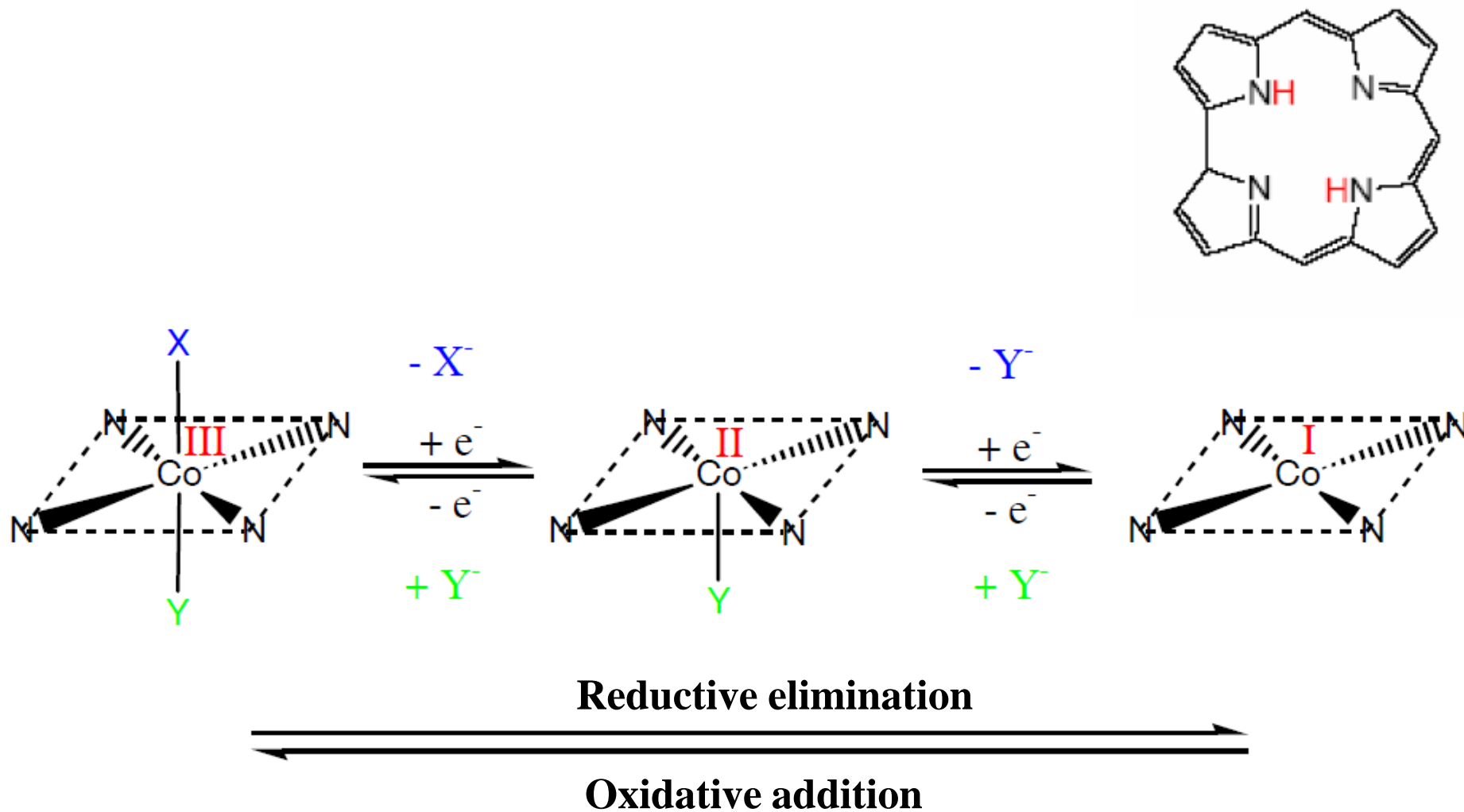

10. Biochemistry of Transition Metals

Co-C-Bond Cleavage

Heterolytic cleavage

Only in presence of
reaction partner



By substitution
with for example
 H_2O to Co(III) and
a carbanion R^-

(EPR inactive)



Formation of a
supernucleophil
 Co(I) and a
carbocation R^+

(EPR inactive)

Homolytic cleavage

Formation of a reactive primary
alkyl radical and low-spin $[\text{Ar}]3\text{d}^7$
cobalt(II)
(EPR active)

10. Biochemistry of Transition Metals

Co-C-Bond Cleavage

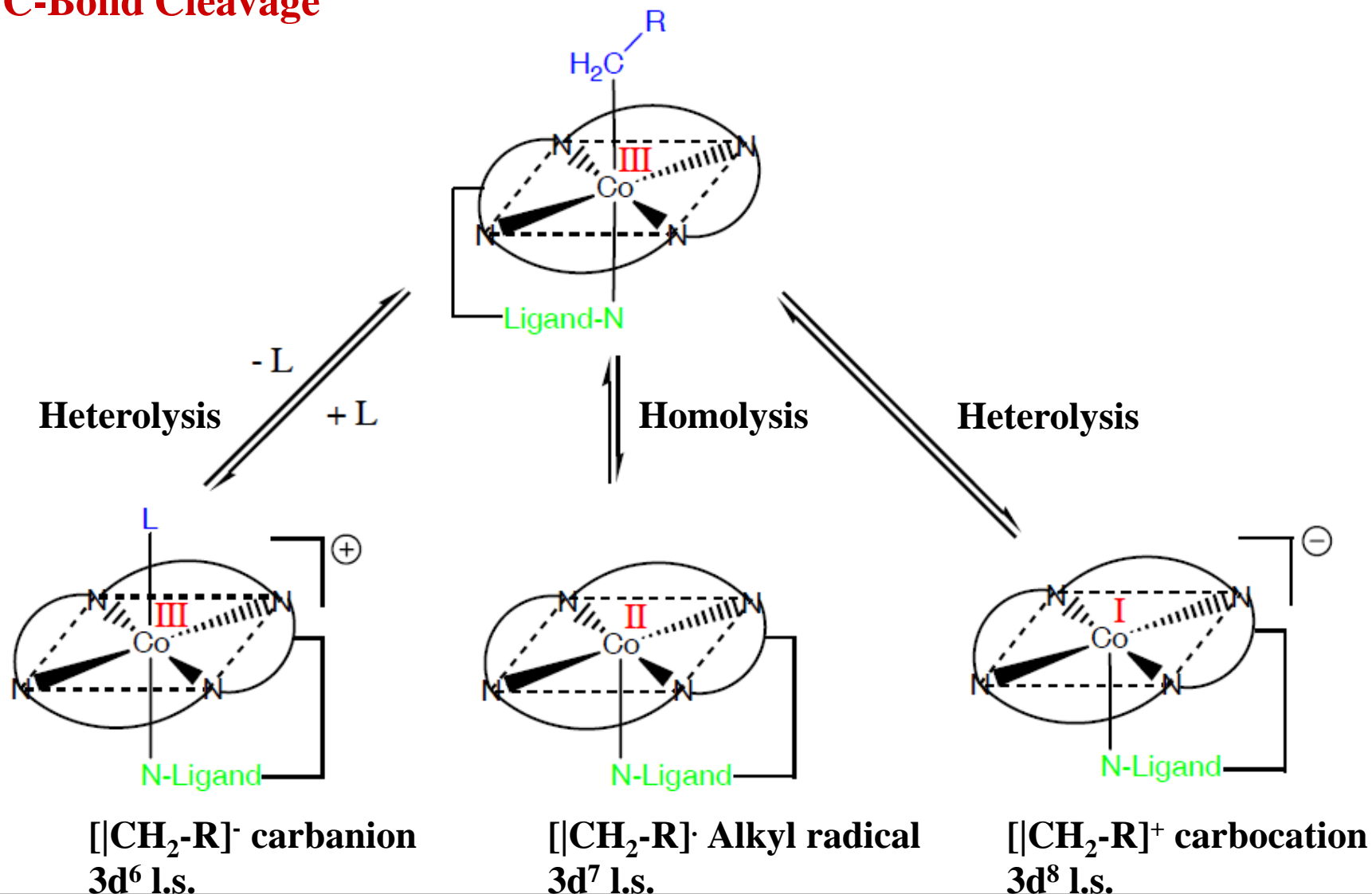

10. Biochemistry of Transition Metals

Homolytic Bond Cleavage

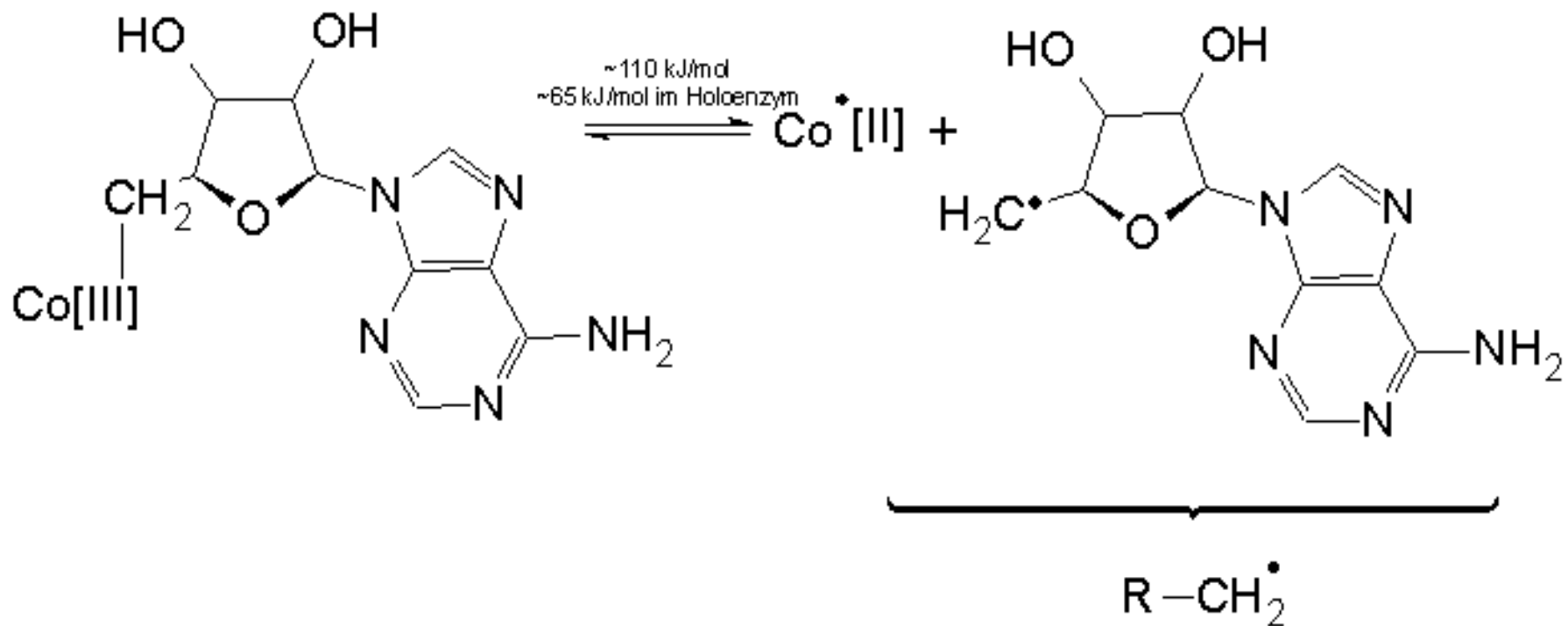

10. Biochemistry of Transition Metals

Methylmalonyl-CoA Mutase

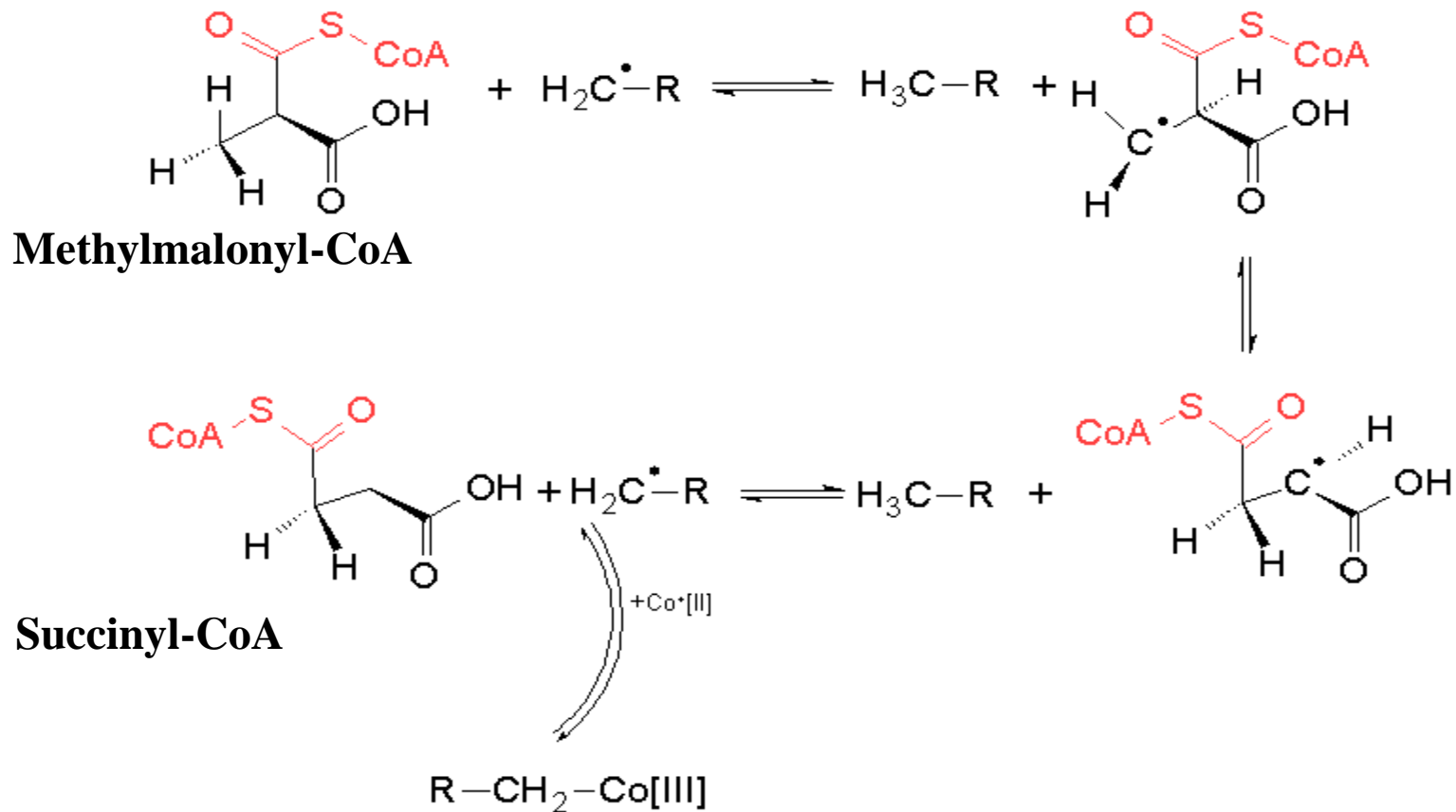

Only indirect involvement of the Co-complex

10. Biochemistry of Transition Metals

Methylmalonyl-CoA Mutase

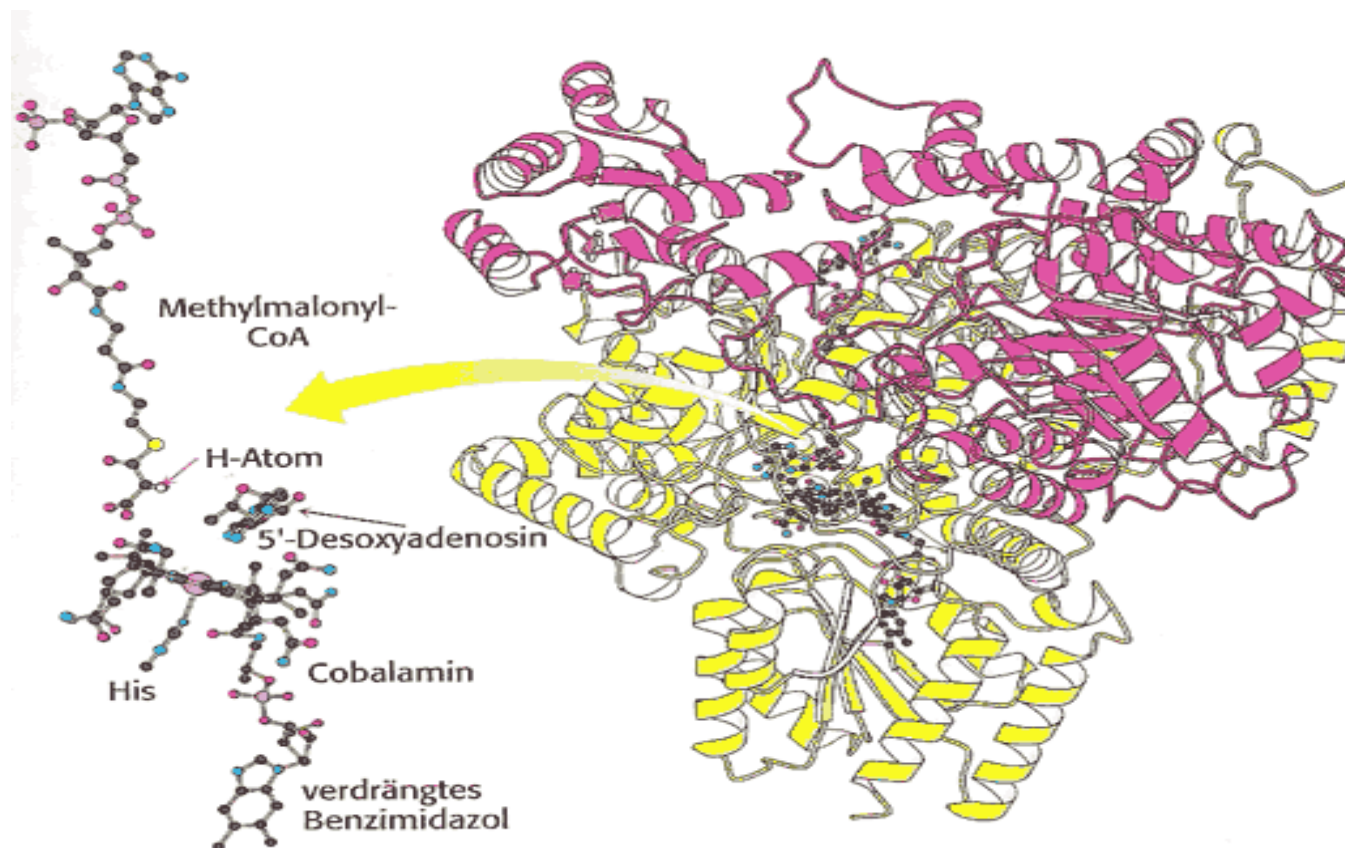

Source: <http://www1.tu-darmstadt.de/fb/ch/akplenio/moproc/metalloproteine/cobalamin/cob3.htm>

10. Biochemistry of Transition Metals

Methylation by Tetrahydrofolic Acid (THFA) via Methylcobalamin MeB₁₂

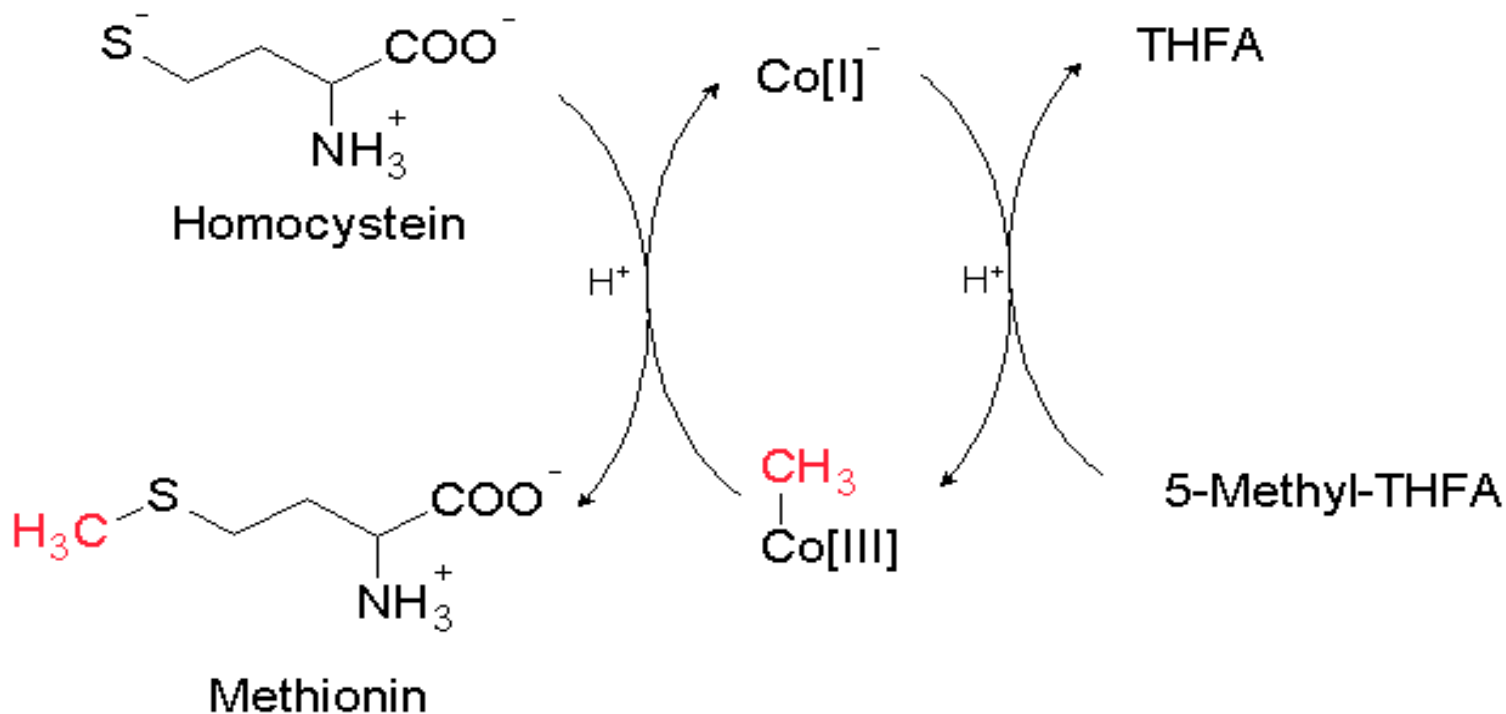

10. Biochemistry of Transition Metals

The Nickel Group

Nickel

Ni^+	$[\text{Ar}]3d^9$	strong reducing agent
Ni^{2+}	$[\text{Ar}]3d^8$ l.s.	stable
Ni^{3+}	$[\text{Ar}]3d^7$ l.s.	strong oxidising agent, low-spin

Palladium

Extremely scarce

Pd^{2+}	$[\text{Kr}]3d^8$ l.s.
Pd^{4+}	$[\text{Kr}]3d^6$ l.s.

Platinum

Extremely scarce

Pt^{2+}	$[\text{Xe}]4f^{14}3d^8$ l.s.	Cis-platinum $[\text{PtCl}_2(\text{NH}_3)_2]$ is cancerostatic
Pt^{4+}	$[\text{Xe}]4f^{14}3d^6$ l.s.	Pt^{4+} -complexes are kinetically extremely stable (OLEDs)

10. Biochemistry of Transition Metals

The Nickel Group

Nickel(II) chemistry

Hydrolysis



Coordination compounds

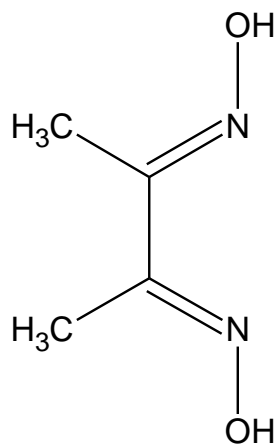
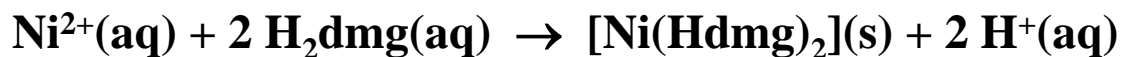

Dimethylglyoxime (H_2dmg)

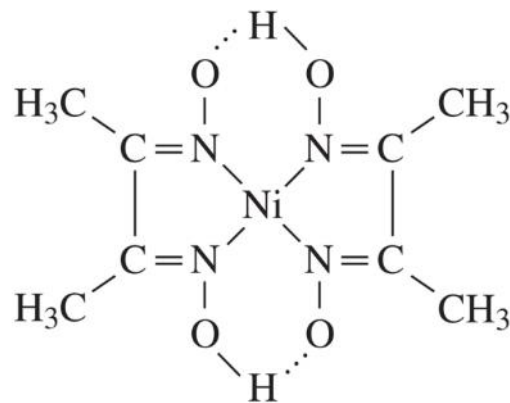

Aus "Allgemeine und Anorganische Chemie" (Eisenstein, Jüdel, Wöhler, Bayer-Carlsen), erschienen bei Spektrum Akademischer Verlag, Heidelberg, © 2004 Elsevier GmbH München, Abbildung 24-34b, pg

Bis(dimethylglyoximate)nickel(II)

10. Biochemistry of Transition Metals

The Nickel Group

Nickel(II)-complexes

Typical for Ni^{2+} are octahedral, square-planar and tetrahedral complexes

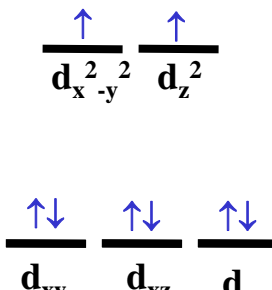
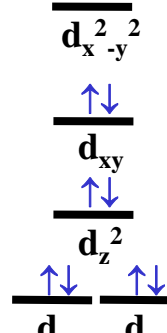
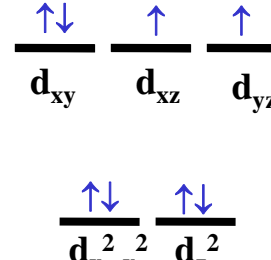
Octahedral	Square-planar	Tetrahedral
H_2O NH_3 Ethylenediamine	Strong ligands, such as CN^- or Hdmg that force a square- planar arrangement	Cl^- Br^- I^-
Green, blue to violet Paramagnetic	Yellow, red Diamagnetic	Blue Paramagnetic
		

10. Biochemistry of Transition Metals

Nickel(II)-Proteins

a) **Ureasases:** Catalyse the decomposition of urea

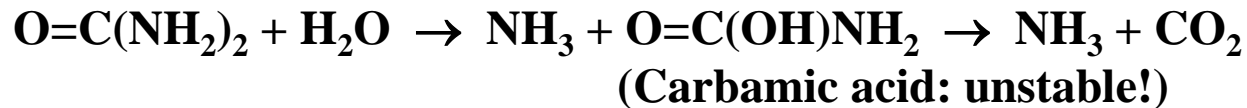

b) **Ni-Fe-CO-hydrogenases:**

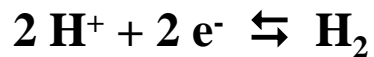

c) **Acetyl-CoA-synthetases:**

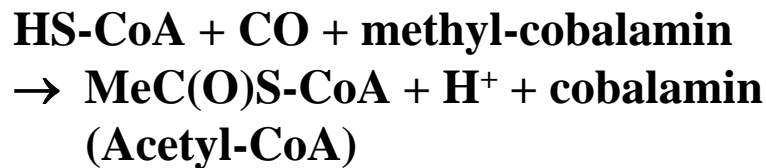

⇒ Acetyl-CoA = Precursor for acetylation reactions

d) **Ni superoxid dismutase**
→ decomposition of O_2^- Radicals

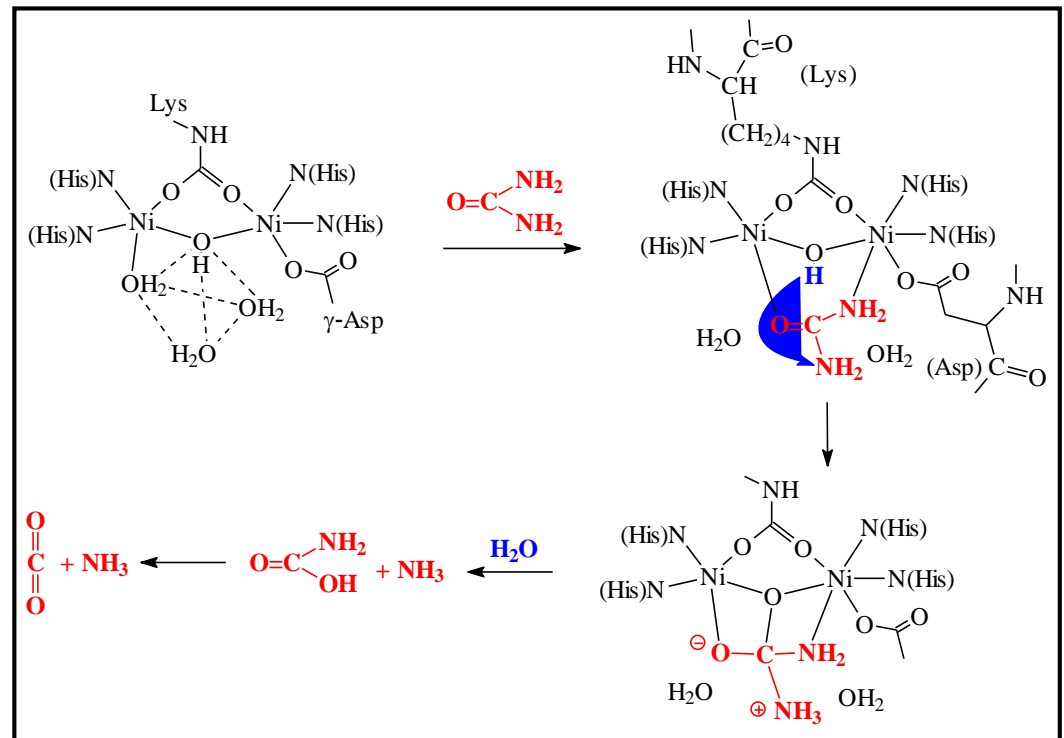

10. Biochemistry of Transition Metals

The Copper Group

Copper

Cu^0	$[\text{Ar}]3\text{d}^{10}5\text{s}^1$	colloidal copper is antiseptic
Cu^+	$[\text{Ar}]3\text{d}^{10}$	tends to disproportionate, labile complexes
Cu^{2+}	$[\text{Ar}]3\text{d}^9$	moderate oxidising agents (glucose-detection)
Cu^{3+}	$[\text{Ar}]3\text{d}^8$	strong oxidising agent, stable l.s.-complexes

Silver

Scarce

Ag^0	$[\text{Kr}]4\text{d}^{10}5\text{s}^1$	colloidal silver acts antimicrobial
Ag^+	$[\text{Kr}]4\text{d}^{10}$	strong oxidising agent
Ag^{2+}	$[\text{Kr}]4\text{d}^9$	very strong oxidising agent



Gold

Extremely scarce

Au^0	$[\text{Xe}]4\text{f}^{14}5\text{d}^{10}6\text{s}^1$	“Beaten gold“ is approved for food → E175
Au^+	$[\text{Xe}]4\text{f}^{14}5\text{d}^{10}$	$\text{Na}[\text{Au}(\text{CN})_2]$ → Treatment of rheumatoid arthritis
Au^{3+}	$[\text{Xe}]4\text{f}^{14}5\text{d}^8$	$\text{H}[\text{AuCl}_4]$ → Extraction of purple of Cassius

10. Biochemistry of Transition Metals

The Copper Group

Crystal field splitting and stereo chemistry

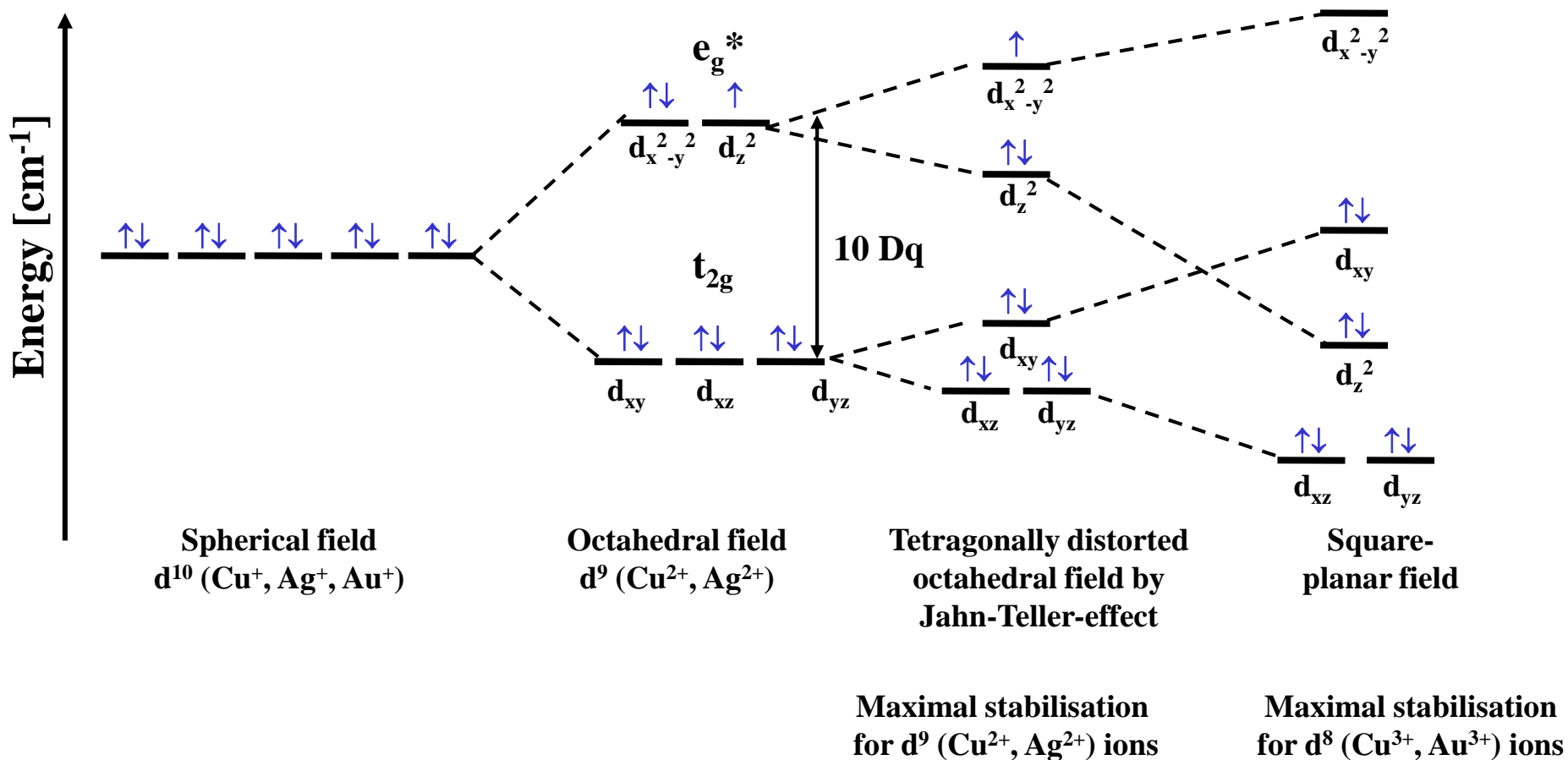

10. Biochemistry of Transition Metals

Copper Proteins

Some functions

- **Electron transport, e.g. in respiratory chain (cytochrome-*c*-oxidase) and in the electron transport chain of PSII to PSI: plastocyanine + azurin**
- **Oxygen transport: haemocyanines**
- **Regulation of iron and copper resorption: ceruloplasmin**
- **One-electron redox processes, e.g. in nitrite reductase: $\text{NO}_2^- \rightarrow \text{NO}$**
- **Two-electron redox processes, e.g. in galactose oxidase: $\text{RCH}_2\text{OH} \rightarrow \text{RCHO}$**
- **Disproportionation: detoxification of superoxide anion radical by CuZn-superoxide dismutase: $2 \text{O}_2^- + 2 \text{H}^+ \rightarrow \text{H}_2\text{O}_2 + \text{O}_2$**
- **Oxygenation of organic substrates, e.g. by tyrosinase:
Tyrosine \rightarrow dopa \rightarrow indolquinone \rightarrow melanin**
- **Acetyl-coenzym-A-synthetase: $\text{CO} + \{\text{CH}_3\} + \text{CoA} \rightarrow \text{CH}_3\text{-C(O)-CoA}$**
- **As bio mineral: Atacamite = $\text{Cu(OH)}_2 \cdot \text{Cu(OH)Cl}$, which stem from teeth of marine blood worms (Genus glycera): Cu^{2+} with melanin**



10. Biochemistry of Transition Metals

Copper Proteins: Type I “Blue Cu-Proteins“

Structure: Trigonal coordination geometry; Cys, His and Met as ligands

Opt. spectra: LMCT-bands ($\text{Cys}^- \rightarrow \text{Cu}^{2+}$) at 600 nm ($\epsilon \sim 3000 \text{ M}^{-1}\text{cm}^{-1}$)

EPR-spectra: 4 hyper-fine lines by coupling with cores ($A = 5 \text{ mT}$)

^{63}Cu ($I = 3/2$, $N = 70\%$)

^{65}Cu ($I = 3/2$, $N = 30\%$)

Function: Mostly electron transport

Example: Plastocyanine, azurin

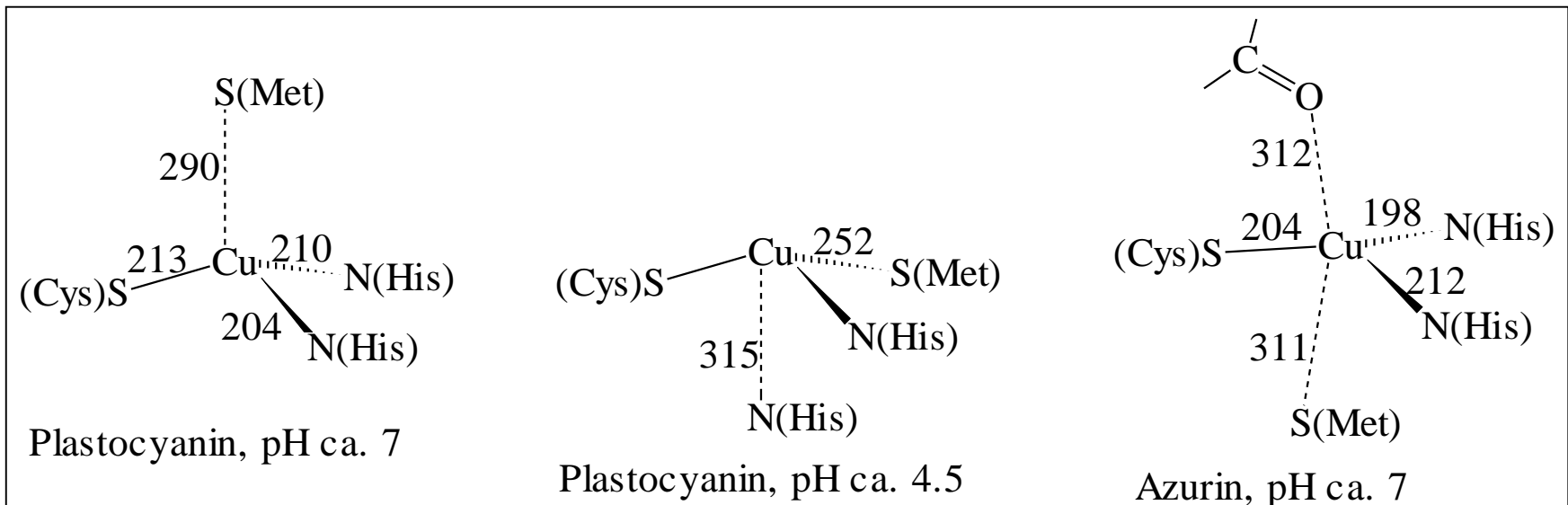

10. Biochemistry of Transition Metals

Copper Proteins: Type II

Structure: Tetragonal coordination geometry, i.e.
3 His- as well as additional O- and N-functional ligands

Opt. spectra: 3d-3d absorption bands

EPR spectra: 4 hyperfine lines by coupling with cores ($A = 18 \text{ mT}$)

^{63}Cu ($I = 3/2$, $N = 70\%$)

^{65}Cu ($I = 3/2$, $N = 30\%$)

Function: Oxidases and
oxygenases

Example: Galactose oxidase:
 $\text{R-CH}_2\text{OH} \rightleftharpoons$

$\text{R-CHO} + 2 \text{H}^+ + 2 \text{e}^-$

CuZn-

Superoxide dismutase:

$2 \text{O}_2^- + 2 \text{H}^+ \rightarrow \text{O}_2 + \text{H}_2\text{O}_2$

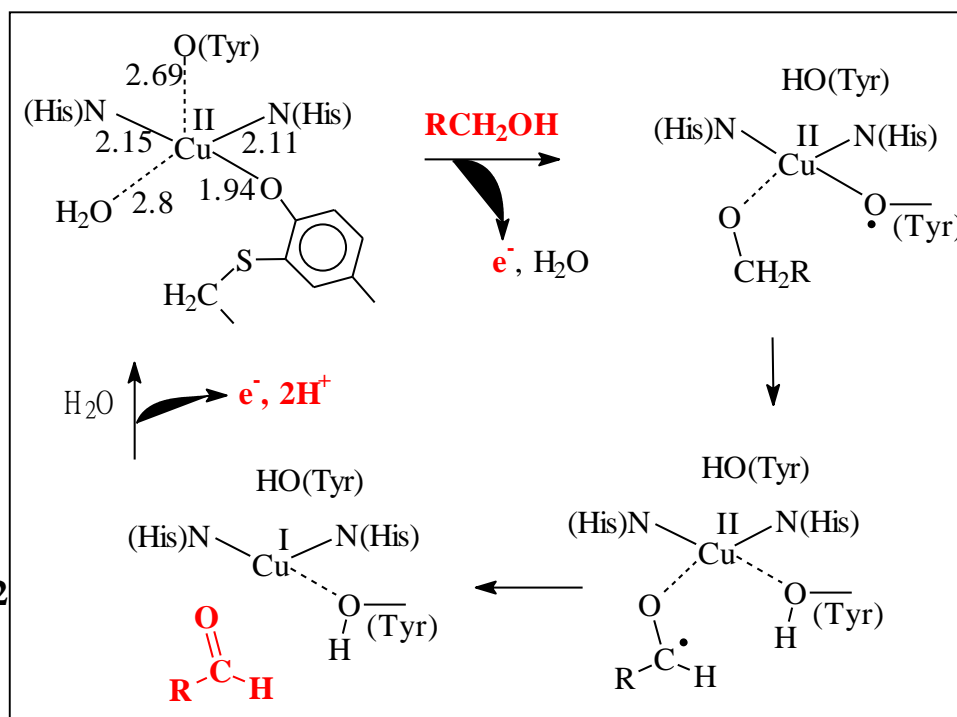

10. Biochemistry of Transition Metals

Copper Proteins: Type III (according to Robin and Day)

- Structure:** Two copper centres of trigonal coordination
3 His-ligands, one peroxide bridge and possibly additional oxy bridges
- Opt. spectra:** LMCT-bands ($O_2^{2-} \rightarrow Cu^{2+}$) at 600 nm ($\epsilon \sim 1000 \text{ M}^{-1}\text{cm}^{-1}$)
- EPR spectra:** EPR-inactive due to anti-ferromagnetic interactions between Cu^{2+} -ions
- Function:** O_2 -transport
- Example:** Haemocyanine
- $$2 Cu^+ + O_2 \rightleftharpoons 2 Cu^{2+} + O_2^{2-}$$
- “oxidative addition“

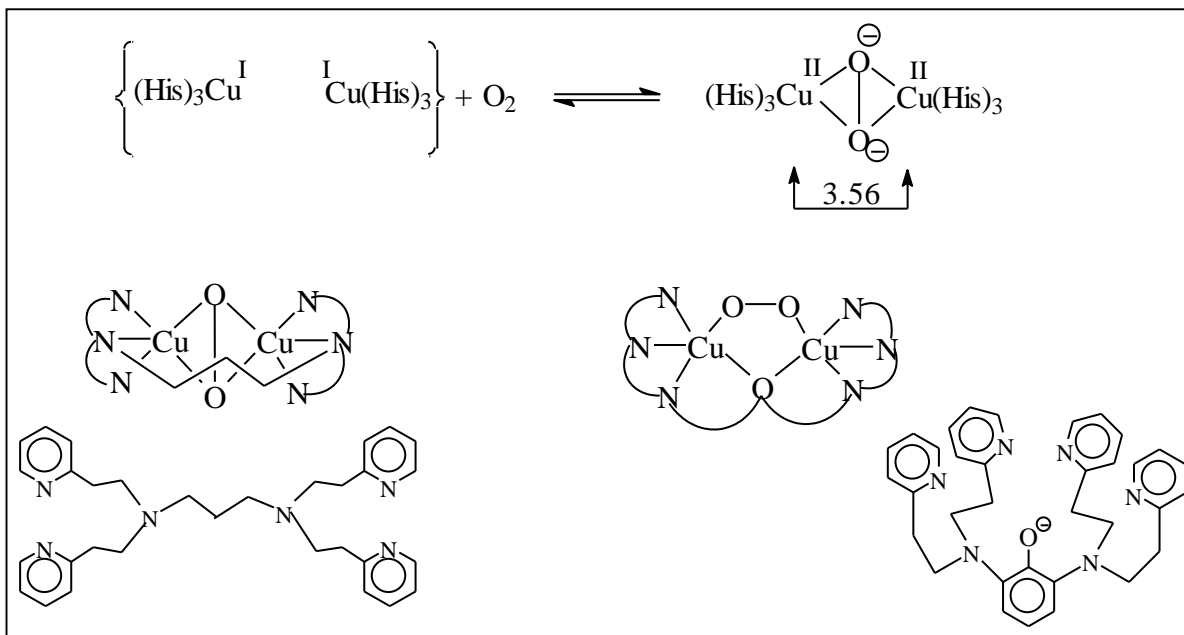

10. Biochemistry of Transition Metals

Copper Proteins: Type A

Structure:	Dual-core, cysteine-bridged copper(I)-centres
Opt. spectra:	Rose due to MLCT
EPR spectra:	EPR-inactive \rightarrow [Ar]3d¹⁰-configuration
Function:	Electron transport
Example:	N₂O-reductase Cytochrome-c oxidase (Cu^A-centre: see below)

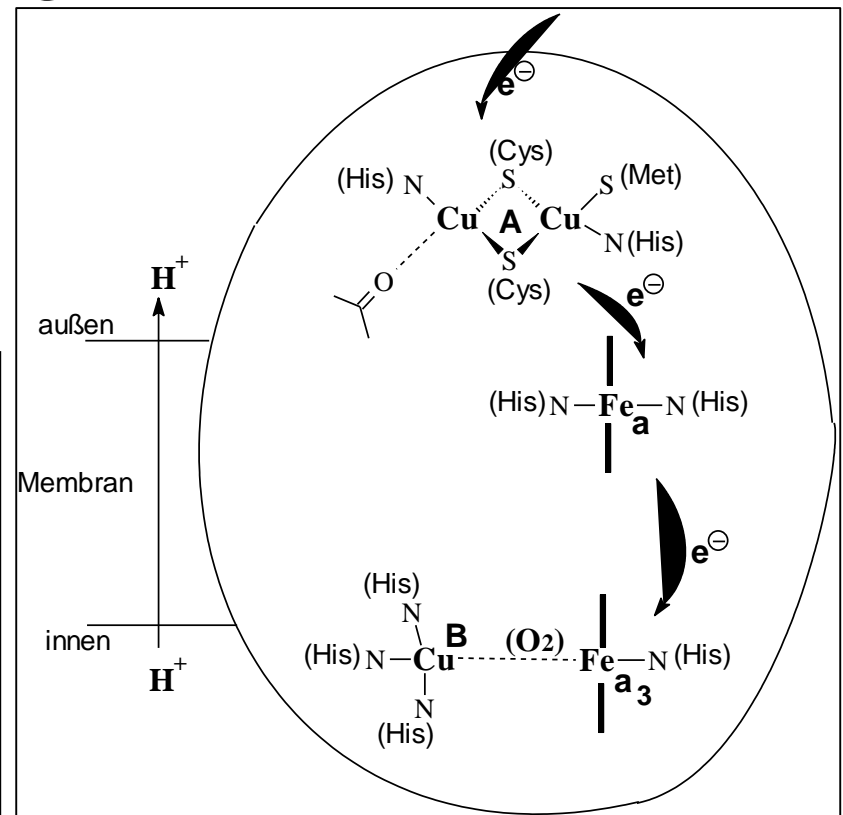
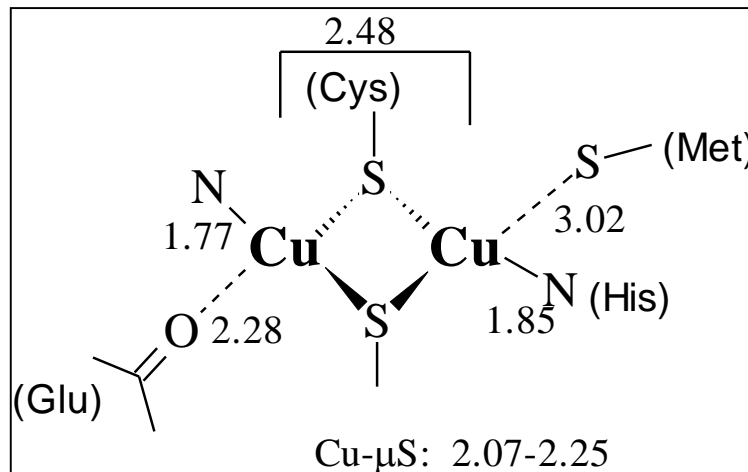

10. Biochemistry of Transition Metals

The Zinc Group

Zinc

Zn^0	$[\text{Ar}]3\text{d}^{10}5\text{s}^2$	strong reducing agents
Zn^{2+}	$[\text{Ar}]3\text{d}^{10}$	(distorted) tetrahedral labile complexes

Cadmium

Scarce

Cd^0	$[\text{Kr}]4\text{d}^{10}5\text{s}^2$	inhaled during smoking (20 cigarettes ~ 1 μg Cd)
Cd^{2+}	$[\text{Kr}]4\text{d}^{10}$	redox-stable, octahedral labile complexes

Mercury

Extremely scarce

Hg^0	$[\text{Xe}]4\text{f}^{14}5\text{d}^{10}6\text{s}^2$	Uptake via respiratory system (MAK-value = 0.1 mg/m^3)
Hg^+	$[\text{Xe}]4\text{f}^{14}5\text{d}^{10}6\text{s}^1$	$[\text{Hg-Hg}]^{2+}$ is diamagnetic, Hg_2Cl_2 is white and decomposes upon irradiation \rightarrow Hg (calomel = nicely black), laxative which damages the kidneys
Hg^{2+}	$[\text{Xe}]4\text{f}^{14}5\text{d}^{10}$	HgS: hexagonal black + cubic red modification HgO: amorphous yellow + crystalline red modification

10. Biochemistry of Transition Metals

Zinc Proteins

Human:	2-2.5 g Zn per 70 kg body weight
Transport:	Resorbed Zn binds to serum albumin and transferrin
Proteins:	Carbonic anhydrase, carboxypeptidase, zinc finger, DNA-repair protein, etc. (several 100 known!)

Some functions

- **Catalytic function: hydrolases (peptidases, phosphatases, lipases), synthetases, isomerases, ligases**
- **Structural functions: stabilisation of tertiary structure of proteins**
- **Hormonal regulation: the hexameric storage modification of insulin is stabilized by three Zn^{2+} - ions coordinated to His, with three aqua ligands completing the coordination sphere of zinc and resulting in a CN of 6**
- **Ada DNA repair-protein: a zinc centre coordinating to four Cys, demethylises methyl phosphate**
- **Zinc storage: by thioneines (heavy metal-binding proteins)**

10. Biochemistry of Transition Metals

Zinc Proteins

CN	Coordination geometry	Ligands
3	Trigonal –pyramidal (seldom)	S
4	Distorted tetrahedral, distorted tetragonal	S, O, N
5	Distorted tetragonal-pyramidal, distorted trigonal bipyramidal	O, N
6	octahedral (seldom)	S

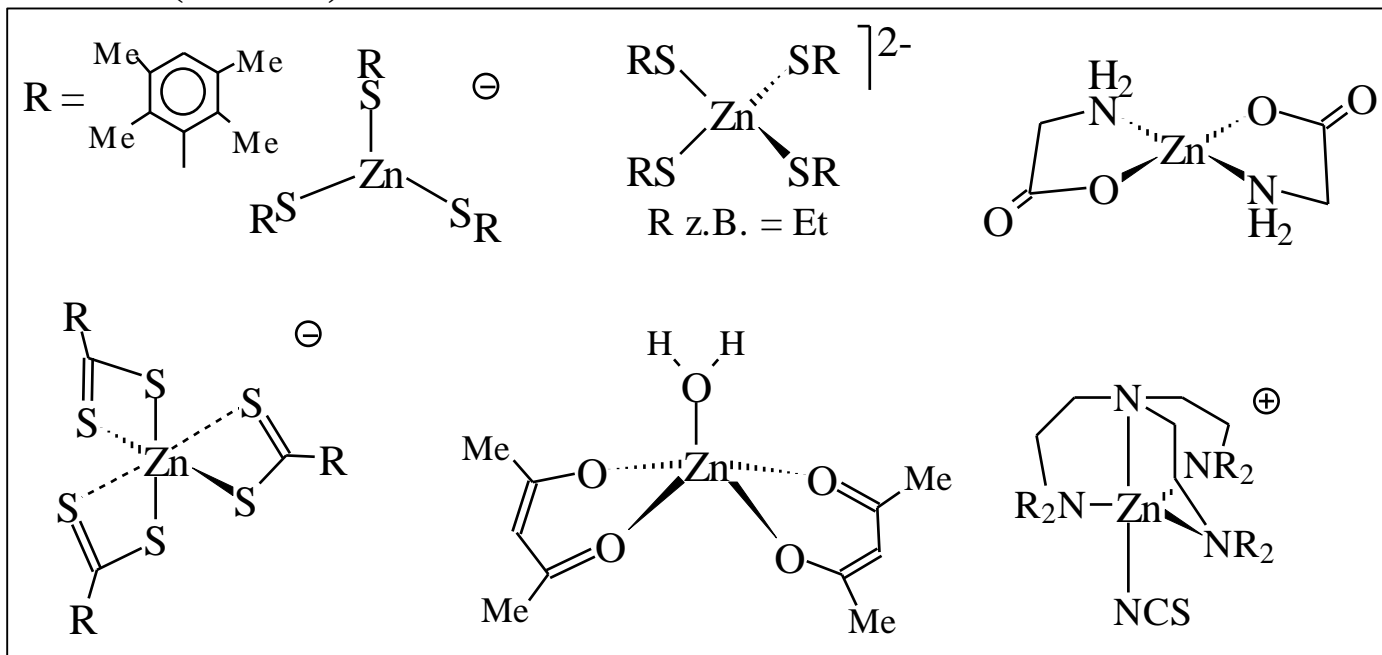

10. Biochemistry of Transition Metals

Zinc Proteins

Substrate activation

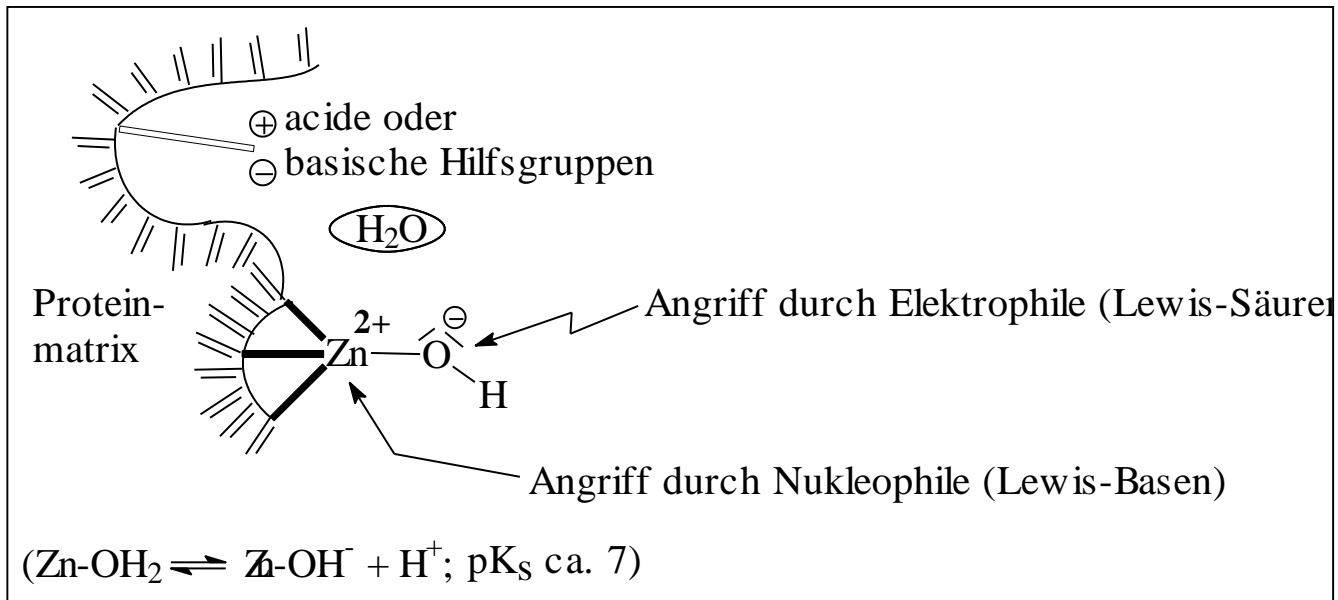

e.g. in alcohol dehydrogenase

Transfer of methyl groups

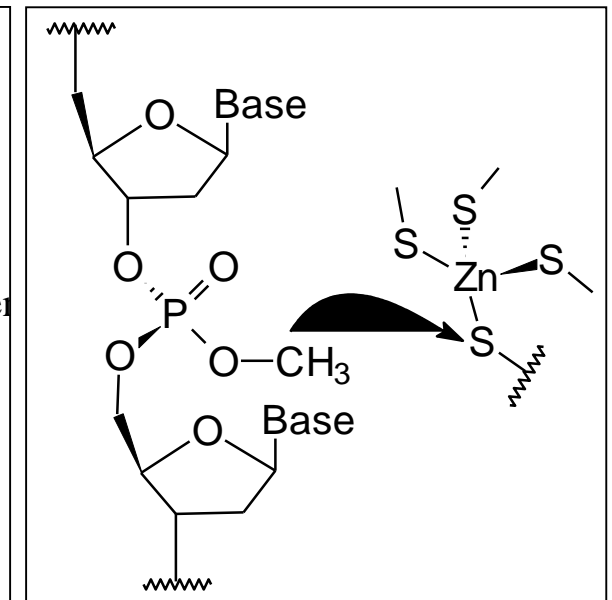

in Ada DNA repair-protein

10. Biochemistry of Transition Metals

Zinc Proteins: Carbonic Anhydrase

Velocity

- Without a catalyst

$$k = 8.5 \cdot 10^3 \text{ M}^{-1}\text{s}^{-1}, k_{-} = 2 \cdot 10^{-4} \text{ s}^{-1}$$

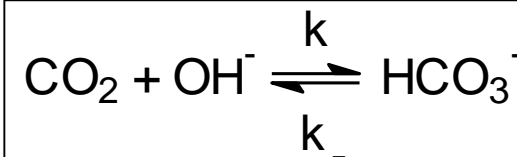
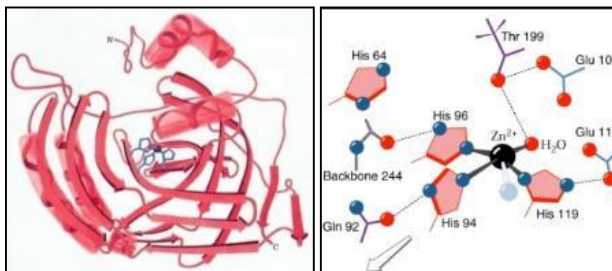

- Enzymatic

Equilibrium adjustment $\sim 10^7$ times faster

- Purpose is the transformation of CO_2 to HCO_3^- at place of origin



- Modell complex: $[\text{Zn}(\text{tpzb})(\text{OH})]$ with tpzb = trispyrazolyl borate

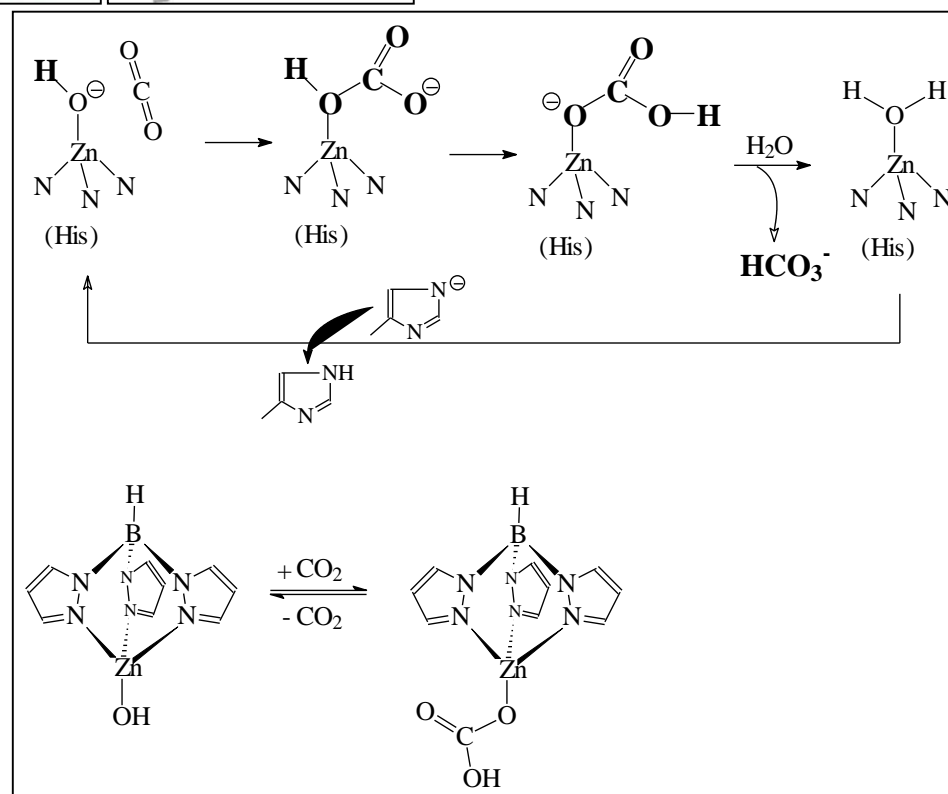

10. Biochemistry of Transition Metals

Cadmium: Biological Aspects of Cd²⁺

- Relation to zinc → deactivation of zinc enzymes through expulsion of Zn²⁺ from the active centre
- Similar ionic radius to Ca²⁺
→ Interference with Ca²⁺-balance, e.g. disruption of Ca²⁺-ATPase and construction of bones
- Acute Cd-intoxications can be treated by glutathione

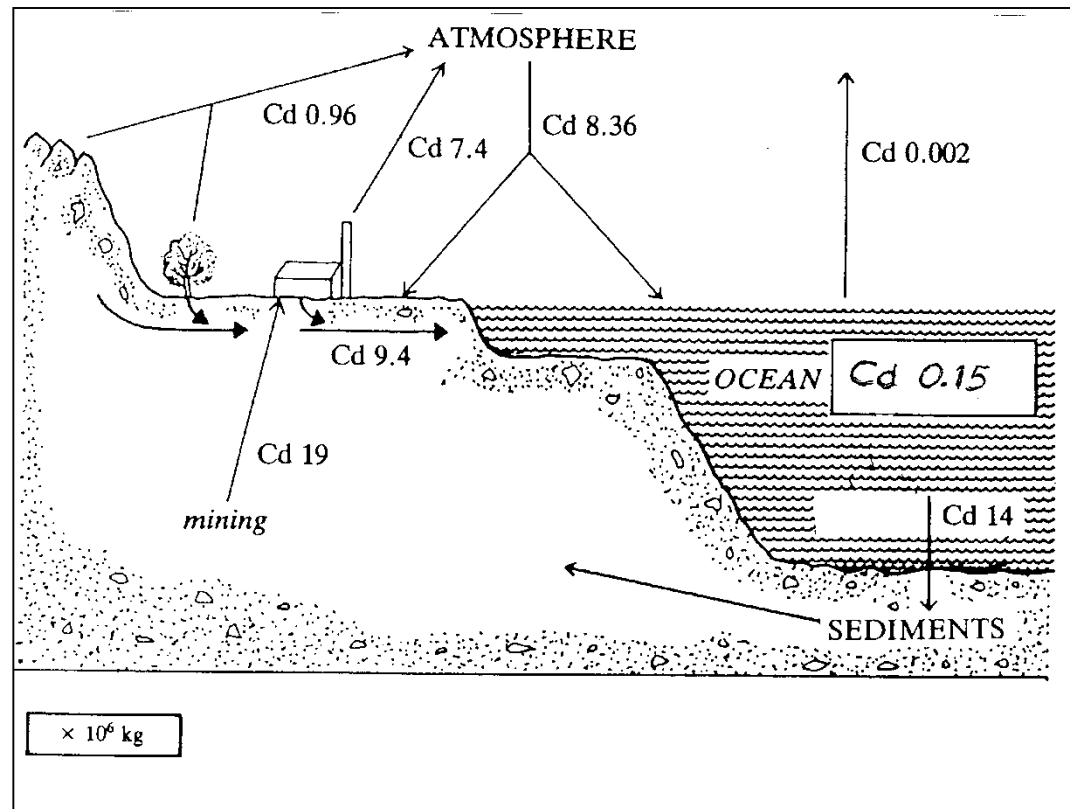

Source: P. O'Neill, Environmental Chemistry, 2nd Ed., Chapman & Hall, London 1993

10. Biochemistry of Transition Metals

Mercury: Biological Aspects of Hg and Hg²⁺

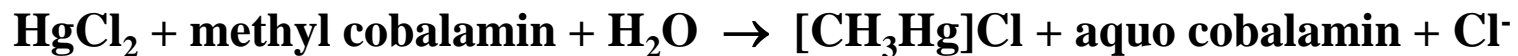

Follow-up reactions: $\text{MeHg}^+ + \text{SR}^- \rightarrow \text{MeHgSR}$ ("Minamata toxine" southern Japan)

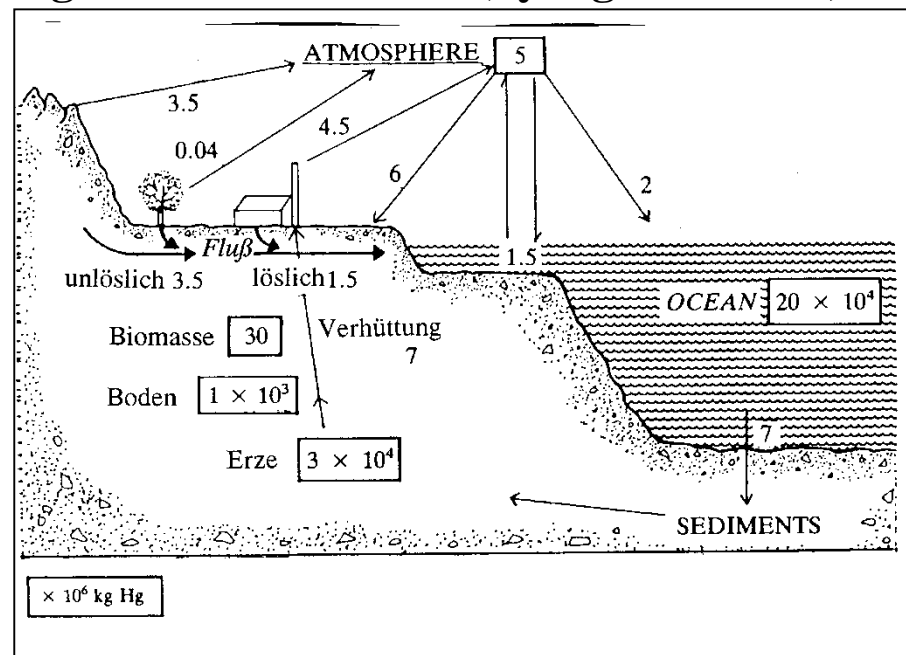
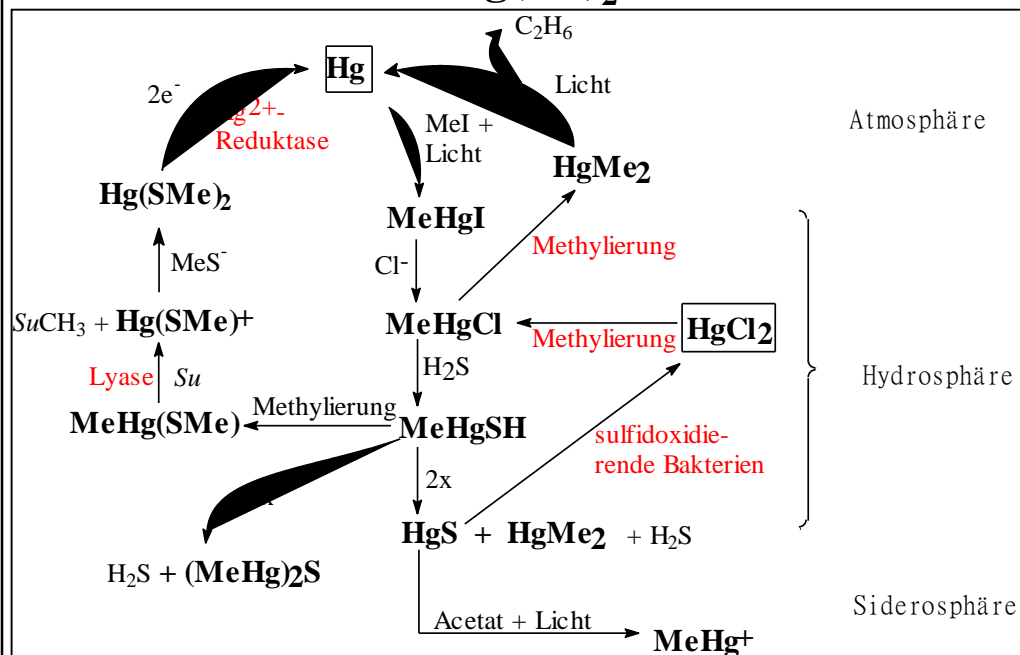
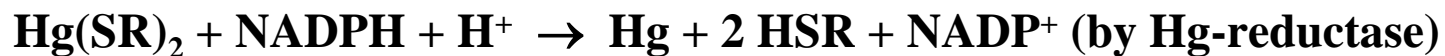

11. Biochemistry of the Lanthanides and Actinides

Lanthanides: Electron configuration

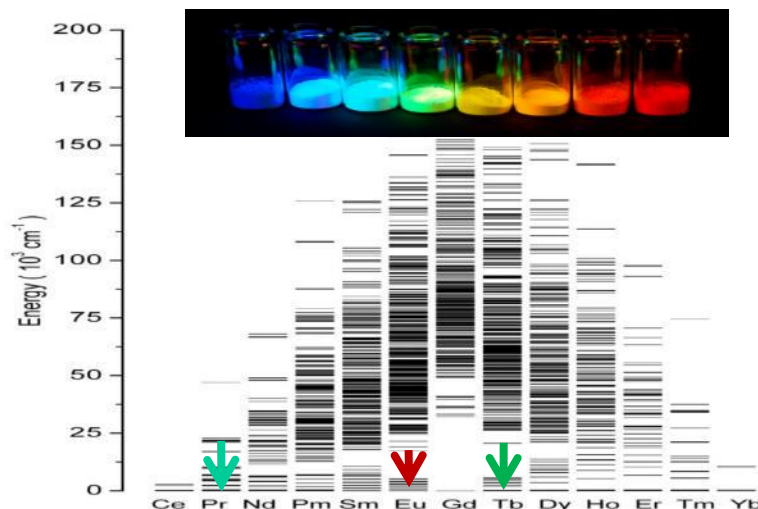
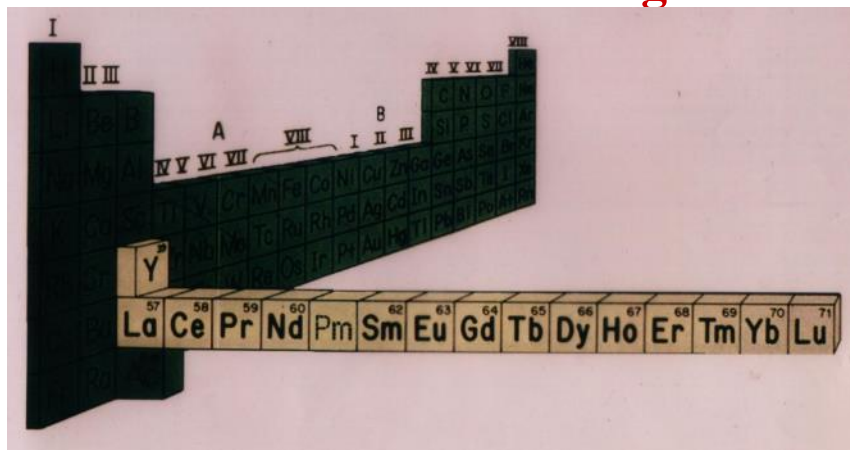

Cations

[Xe]	La ³⁺	Ce ³⁺	Pr ³⁺	Nd ³⁺	Pm ³⁺	Sm ³⁺	Eu ³⁺	Gd ³⁺	Tb ³⁺	Dy ³⁺	Ho ³⁺	Er ³⁺	Tm ³⁺	Yb ³⁺	Lu ³⁺
	Ce ⁴⁺	Pr ⁴⁺	Nd ⁴⁺				Sm ²⁺	Eu ²⁺	Dy ⁴⁺					Tm ²⁺	Yb ²⁺
								Tb ⁴⁺							
4f	0	1	2	3	4	5	6	7	8	9	10	11	12	13	14

Electronic configuration

e.g. of Gd³⁺/Eu²⁺/Tb⁴⁺

	m_l	-3	-2	-1	0	1	2	3	-2	-1	0	1	2	0	-1	0	1
[Xe]		↑	↑	↑	↑	↑	↑	↑	□	□	□	□	□	□	□	□	□
		4f							5d			6s	6p				

Ce³⁺ ... Yb³⁺, Pr⁴⁺, Nd⁴⁺, Tb⁴⁺, Dy⁴⁺, Sm²⁺, Eu²⁺, Tm²⁺

Ce³⁺ ... Yb³⁺

→ paramagnetic ions

→ ions with complex optical spectra

11. Biochemistry of the Lanthanides and Actinides

Lanthanides: MRT contrast enhancement agents – Eu^{2+} and Gd^{3+}

Gadolinium

Gd^{3+} [Xe]4f⁷ acutely toxic, only in complexed form quite safe
extremely strong paramagnet, long electronic relaxation time
Reduction of relaxation time of protons of those aqua ligands,
coordinating to Gd^{3+}

Gd^{3+} -complexes as contrast agents for MRI scans

- $[\text{Gd}(\text{DOTA})]^{2-}$ “Dotarem” DOTA = 1,4,7,10-tetra azacyclo dodecantetraacetate
- $[\text{Gd}(\text{DTPA})(\text{H}_2\text{O})]^{2-}$ “Magnevist” DTPA = diethylene triamine pentaacetate
- $[\text{Gd}(\text{gadoteric acid})]^{2-}$ “Primovist”

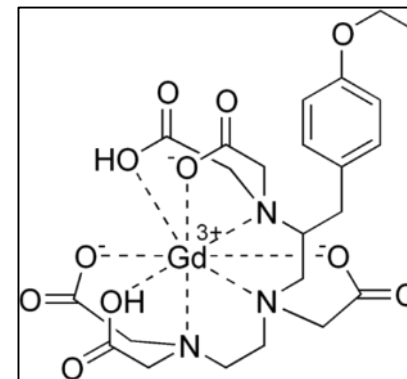
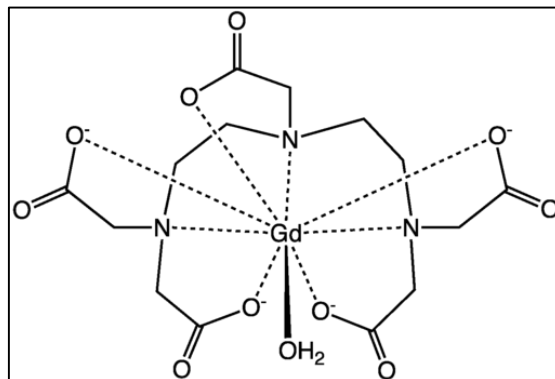
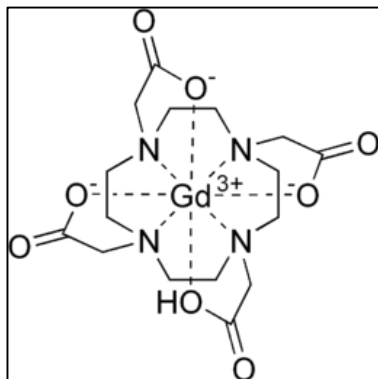

11. Biochemistry of the Lanthanides and Actinides

Lanthanides: Other than Gd³⁺

Trivalent ions

La³⁺ **[Xe]4f⁰** **La-citrate as additive in agriculture to improve feed conversion rate in livestock**
Phosphate binder in hyperphosphatemia

Sm³⁺ **[Xe]4f⁵** **Antibacterial properties of samarium complexes**
 β -emitter ¹⁵³Sm-EDTMP accumulates in bone metastases and has a half-life of 46.3 hours

Tb³⁺ **[Xe]4f⁸** **Luminescent bioassays: Long-lived and bright PL, possibility of multiplexing**

K⁺ sensor complexes:

Lit.: JACS 131 (2008) 434

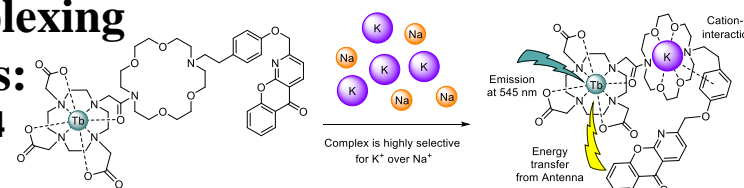

Lu³⁺ **[Xe]4f¹⁴** **¹⁷⁷Lu as emitter of low-energy gamma radiation for imaging and medium energy β -particles for therapy**
LuPO₄ nanoparticles doped with Pr³⁺ and/or Nd³⁺ as UV-C scintillator

11. Biochemistry of the Lanthanides and Actinides

Actinides

Uranium



reacts with hot water: $U + 2 H_2O \rightarrow UO_2 + 2 H_2$
 wide spread, each person comprise about 70 μg uranium
 reducing



UO_2^{2+} is the most stable ion in vivo or aqueous solution

$Na_2U_2O_7$ “Yellow cake“

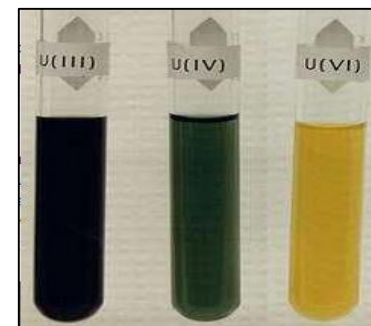

Plutonium



$[Pu(H_2O)_n]^{4+}$ similar ion charge density as Fe^{3+}
 incorporation in iron-containing metalloenzymes

PuO_2 in radionuclide batteries

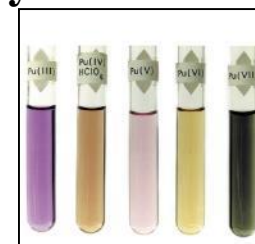

12. Modell Complexes

Aims of the Facilitation of Model Complexes

Structural Models

- Contribution to the structural elucidation of metalloenzymes
- Mimicking optical spectra and magnetic properties

Functional Models

- Elucidation of enzymatic reaction mechanisms
- Investigation of catalytic activity
- Application for lab syntheses of small molecules

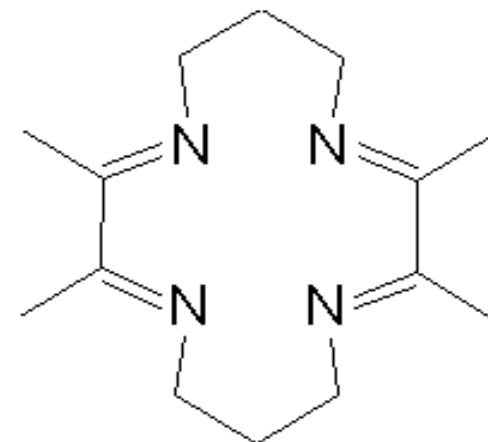

COSTA Ligand

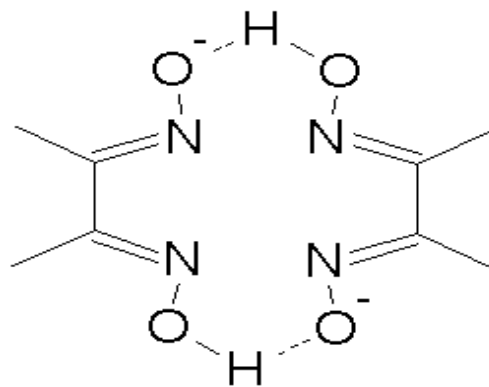

Bis(diacetyldioxim)

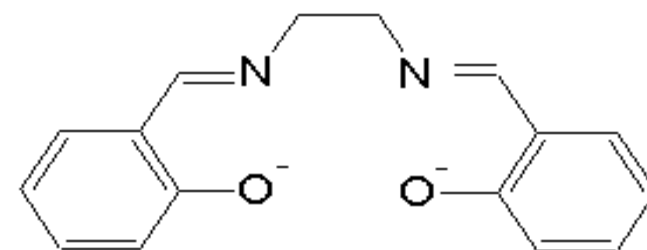

salen Ligand

13. Analytical Methods

Overview

- 1. Diffraction methods (→ clarification of 3D structure)**
 - **Problem: Crystallisation of proteins**
 - **Complex structures limit the resolution to only ca. 0.2 nm, i.e. identification of hydrogen atoms is impossible**
- 2. Electron microscopy (→ 3D structure with intermediate resolution > 1 nm)**
- 3. NMR-Spectroscopy (→ local structure and dynamic properties)**
 - **Problem: Complexity of proteins**
- 4. X-ray absorption spectroscopy, e.g. EXAFS, XANES (→ local structure)**
- 5. EPR-Spectroscopy (→ electronic properties of a species unpaired electrons)**
- 6. Mößbauer Spectroscopy (→ identification of species with quadrupole moment)**
- 7. Optical Spectroscopy (→ colour and electronic properties)**
- 8. SQUID (→ characterisation of magnetic materials)**
- 9. Cyclic voltammetry (→ characterisation of redox processes, e.g. electron transfers)**
- 10. Vibrational spectroscopy, e.g. IR-, Raman-, Resonance-Raman-Spectroscopy (→ detection of functional groups)**
 - **Problem: Complexity of proteins**

14. Applications Areas of Bioinorganic Chemistry

a) Commercial Production and Biotechnology

- Anaerobe bacterial decomposition in sewage treatment plants or sediments: Fe, Ni, Co
- Bacterial leaching (e.g. > 25% of global copper production): Fe, Cu, Au, U

b) Environmental Chemistry

- Agricultural trace element problems: nitrogen fixation (Fe, Mo, V)
- **Environmental impact: Pb, Cd, Hg, As, Al, Cr**
- Pollutant decomposition and detoxification, e.g. by peroxidases: Fe, Mn, V
- **Phytoextraction/-leaching: Cr, Mn, Co, Ni, Cu, Ag, Au, Zn, Cd, Hg, In, Ga, Ge, Sn, As, Eu, Gd, Tb, Lu, ...**

c) Pharmacy

- **Diagnostics: Fe³⁺, Gd³⁺, Ba²⁺, Tc³⁺, Xe**
- **Therapeutics: Pt, Au, Li, B, Gd, Bi, As, Hg**
- **“Cis-platinum“, cis-PtCl₂(NH₃)₂, for the treatment of certain types of tumours**
- **Radio-iodine-therapy, e.g. in case of excessive thyroid function**
- **Metabolism through P-450-enzymes, metalloenzymes blocker: Fe, Zn**

14. Applications Areas of Bioinorganic Chemistry

d) Biomaterials

- Biocompatible (dental) implants
- Treatment of undesired demineralisation processes such as osteoporosis or caries: Ca^{2+} , PO_4^{3-} , F^-
- Biocompatible light guides

e) Inorganic Food Ingredients

- Deficiency symptoms → supplementation: Fe, Co, Zn, Se, ...
- Intoxications → complexation, e.g. during EDTA-therapy
- Precaution → iodine blockade through administration of KI, e.g. in case of a potential exposure to ^{131}I
- Food Design → TiO_2 nanoparticles

14. Applications Areas of Bioinorganic Chemistry

Environmental impact of heavy metals: Dissipation ↔ Toxicology

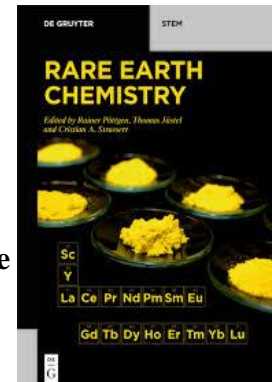
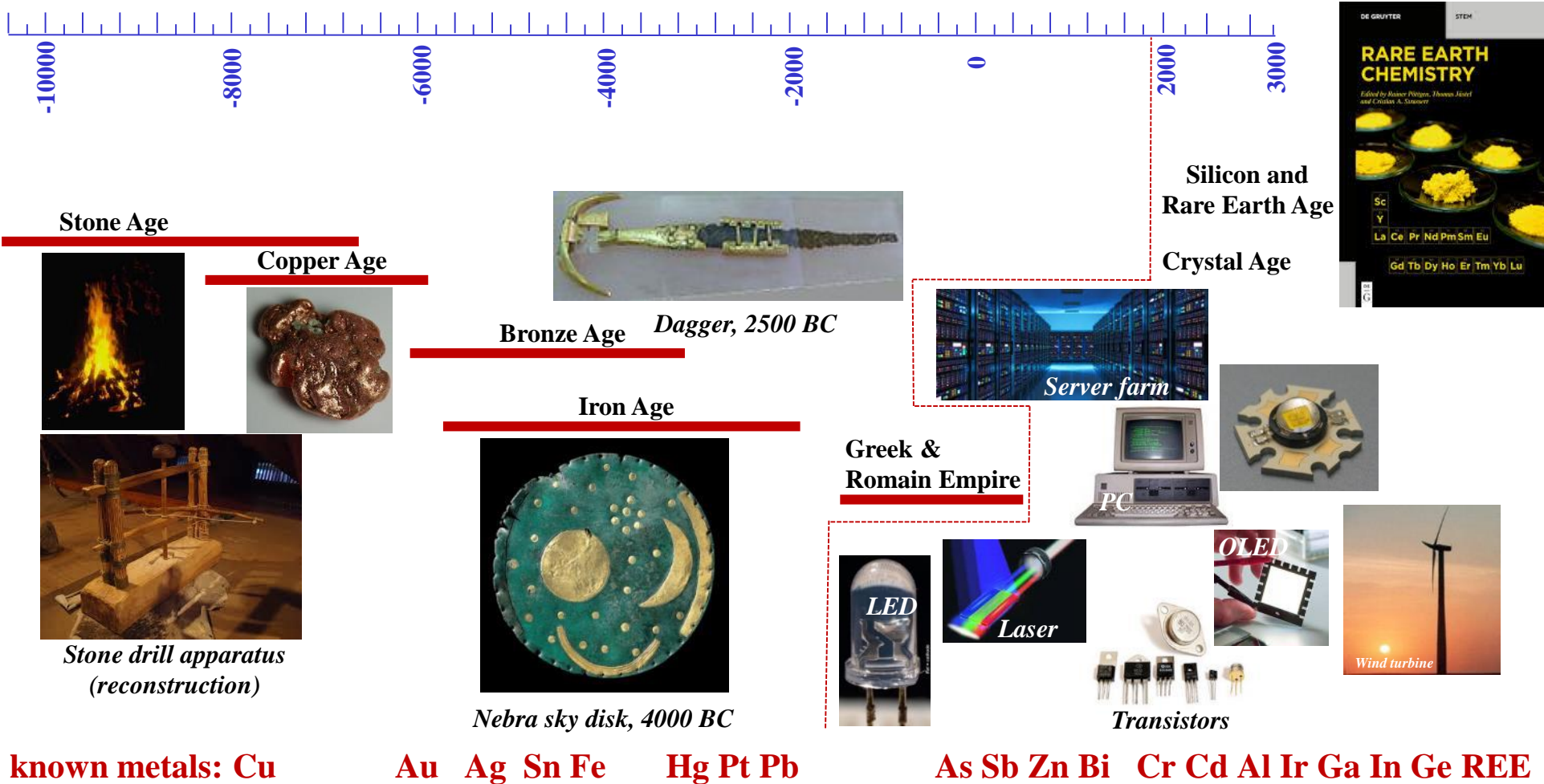

14. Applications Areas of Bioinorganic Chemistry

Phytoextraction/-leaching

Phytoextraction is to extract metal from soil substrates where plants capable of growing in high mineral environments

→ Zn, Cd, Hg, Pb,

(Lit.: Chaney et al., 1998)

Phytomining concerns extracting metals from soil substrates by harvesting specially selected hyper-accumulating plants

→ Ge, Ga, In, Sn,

(Lit.: Sheoran, S. Sheoran & Poonia, 2013)

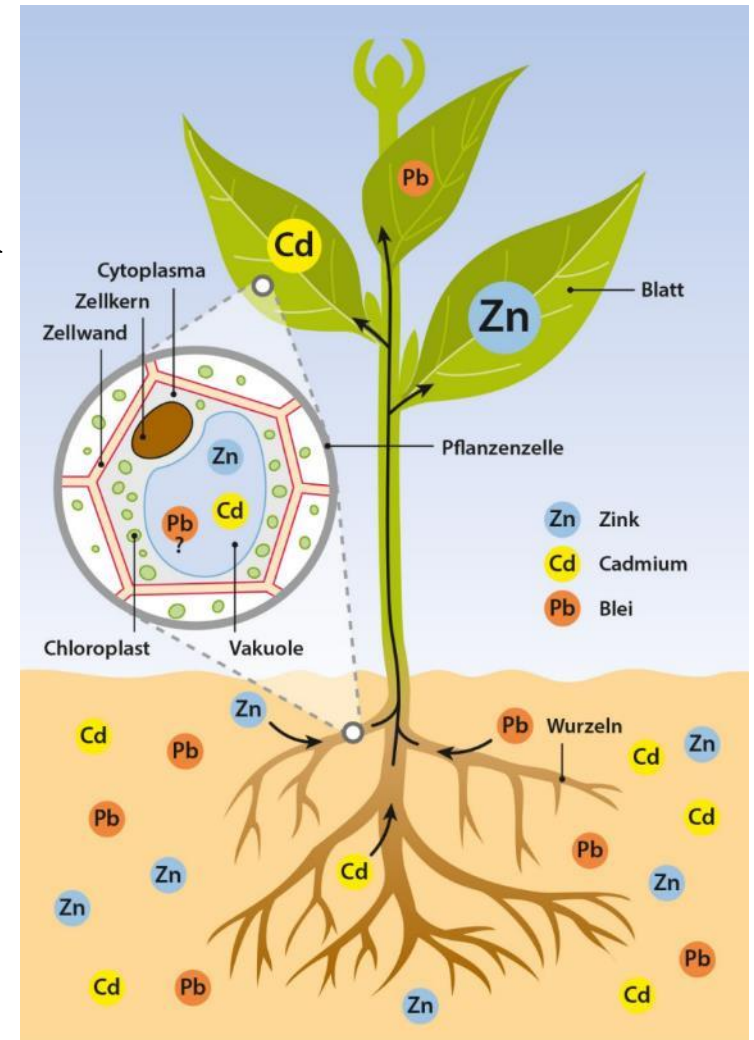

Lit.: <https://motherboard.vice.com/de/article/phytomining>