

# „Dazwischen“

---

## Endpräsentation

Martha Bamberg

Pauline Brinkmann

Maisha Grimm

ba. m3.2 Baukonstruktion - Sommersemester 2020

Prof. Dipl.-Ing. Martin Ebert

Fachhochschule Münster - MSA Münster School of Architecture



Lageplan  
M 1:200

Gruppe 2  
Martha Bamberg,  
Pauline Brinkmann,  
Maisha Grimm

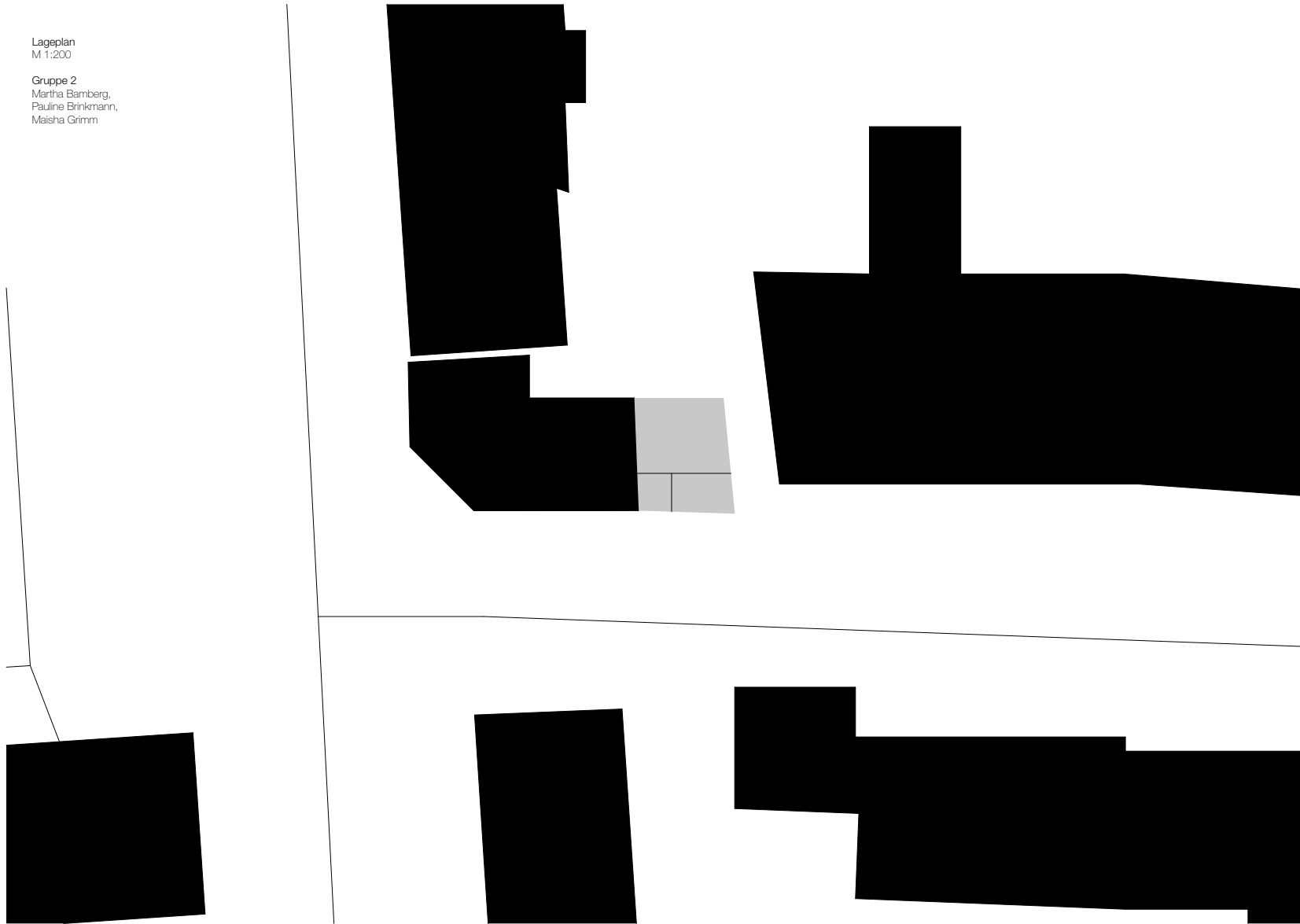

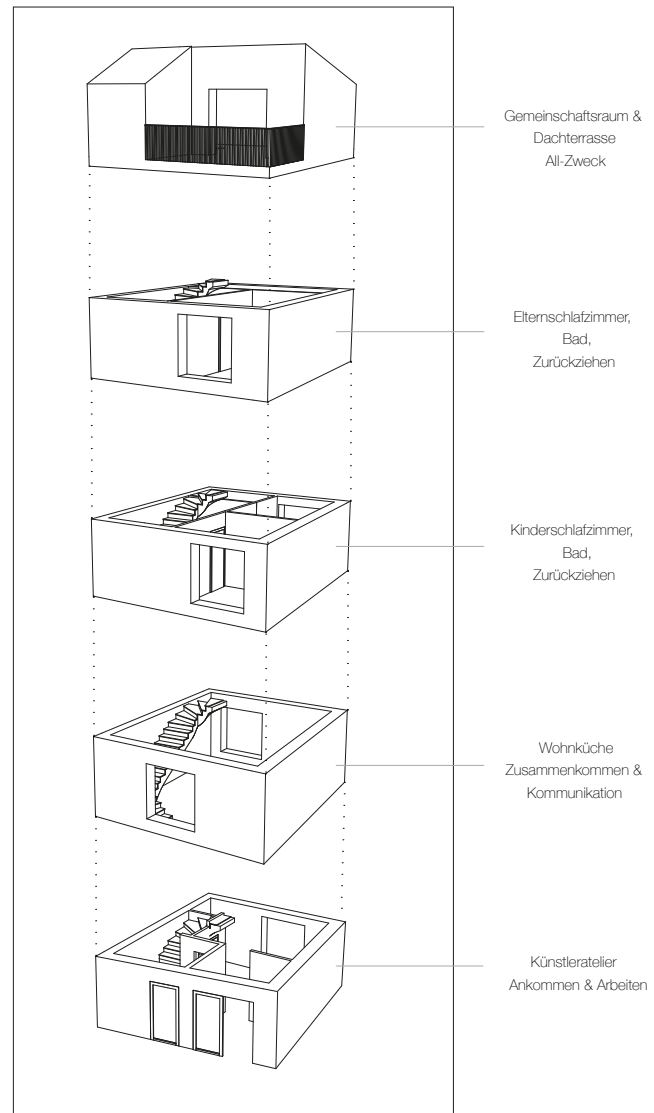



Grundriss EG  
M 1:50

Gruppe 2  
Martha Bamberg,  
Pauline Brinkmann,  
Maisha Grimm

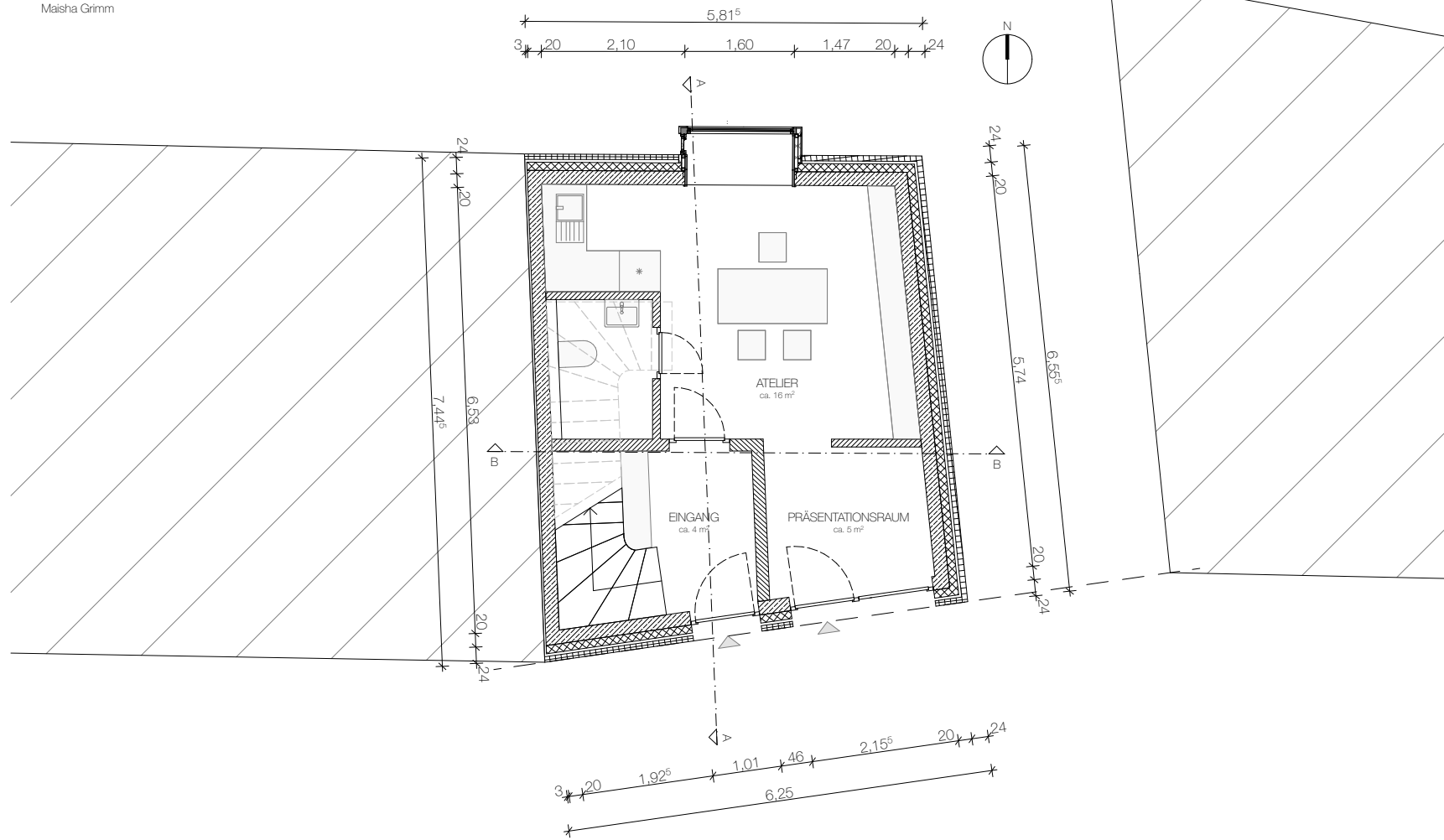

Grundriss 1.OG  
M 1:50

Gruppe 2  
Martha Bamberg,  
Pauline Brinkmann,  
Maisha Grimm

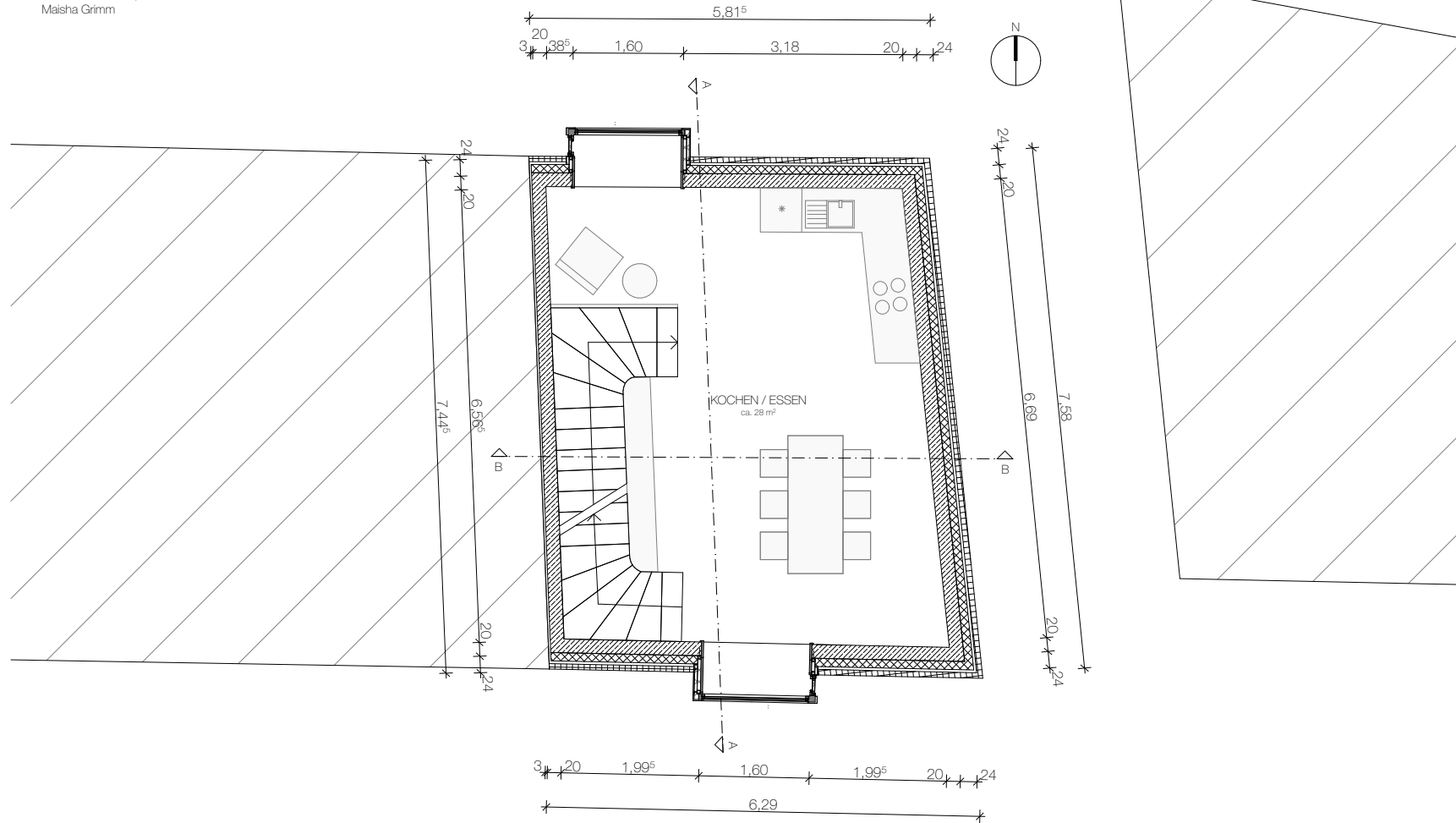

Grundriss 2.OG  
M 1:50

Gruppe 2  
Martha Bamberg,  
Pauline Brinkmann,  
Maisha Grimm

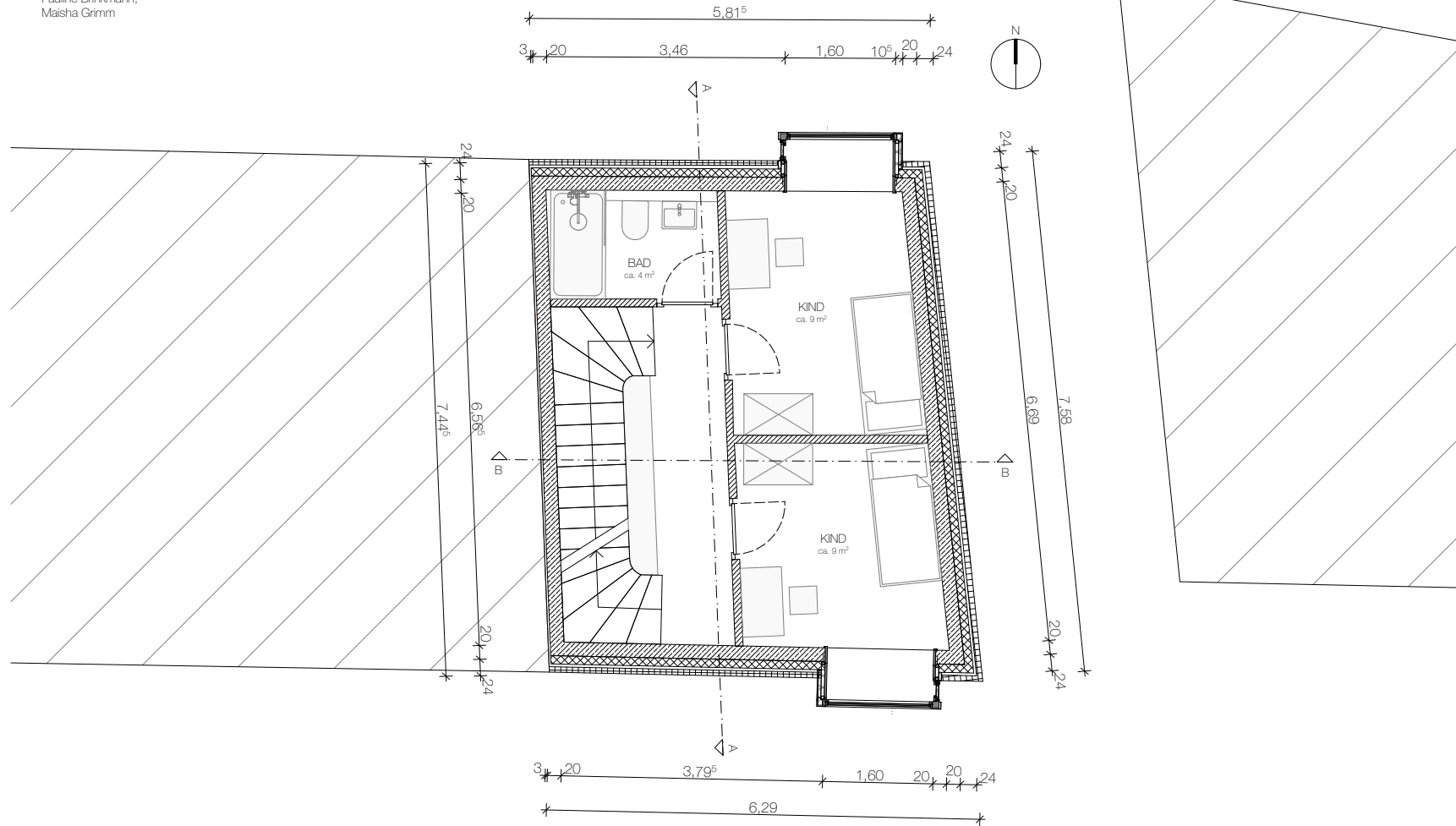

Grundriss 3.OG  
M 1:50

Gruppe 2  
Martha Bamberg,  
Pauline Brinkmann,  
Maisha Grimm

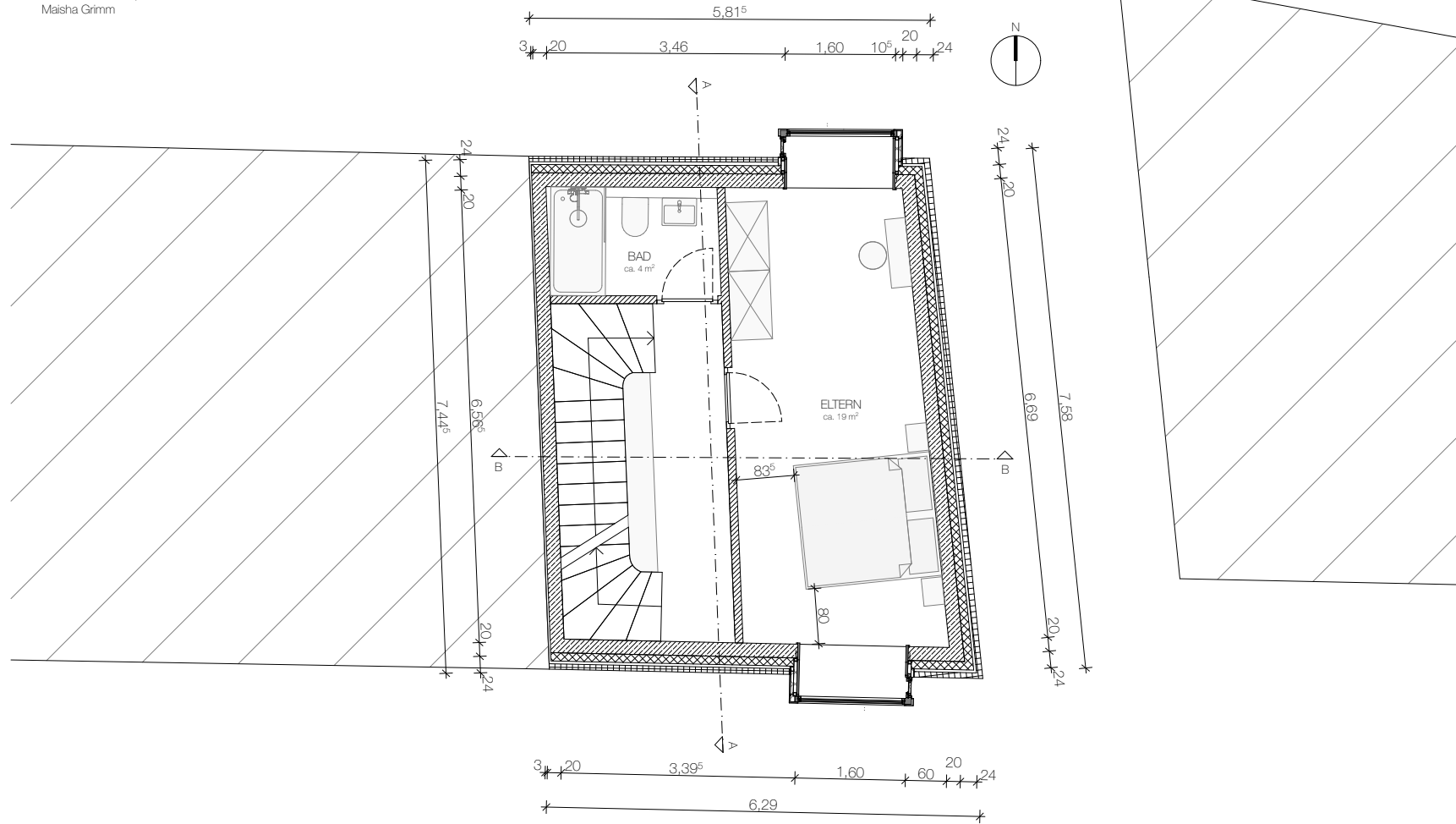

Grundriss 4.OG  
M 1:50

Gruppe 2  
Martha Bamberg,  
Pauline Brinkmann,  
Maisha Grimm

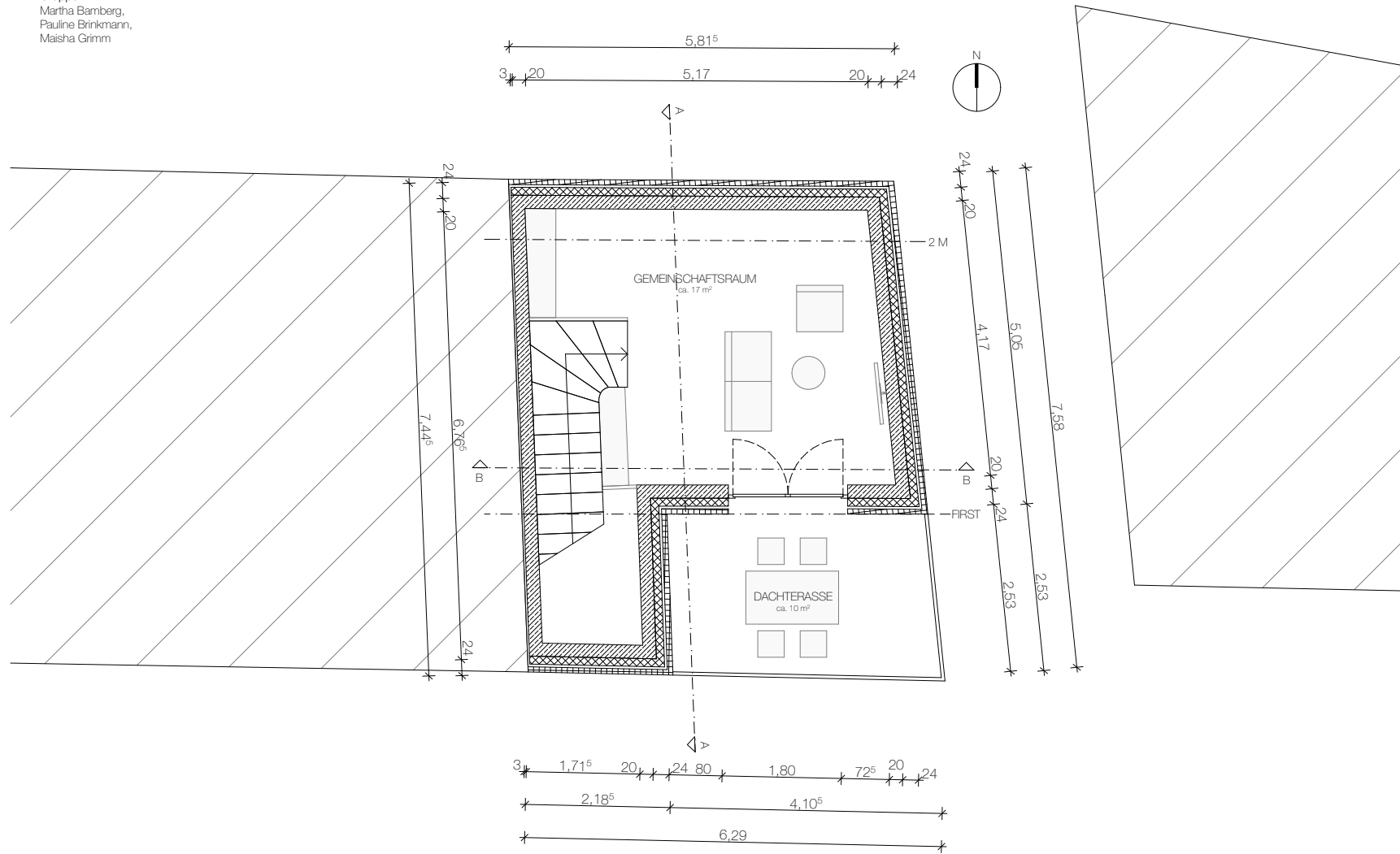







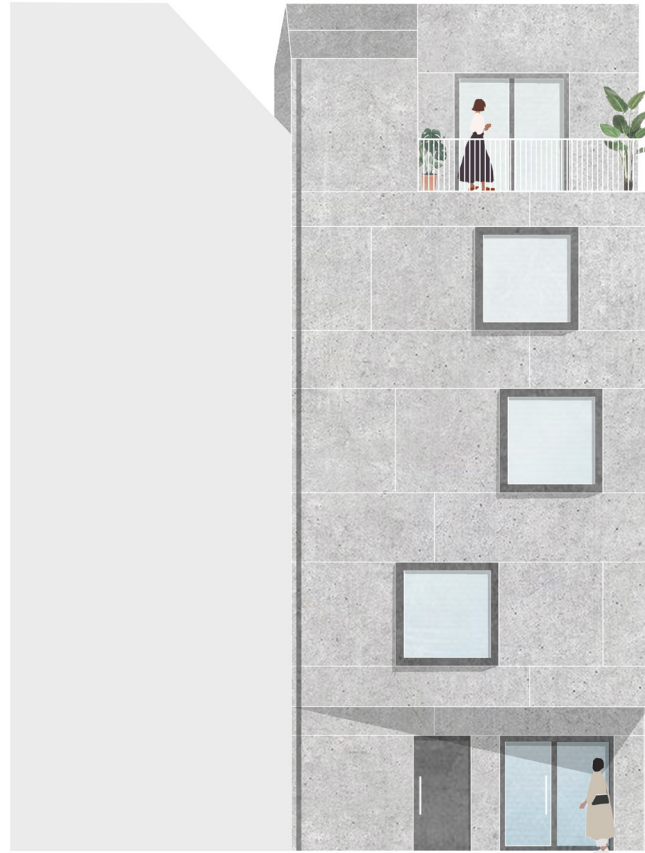



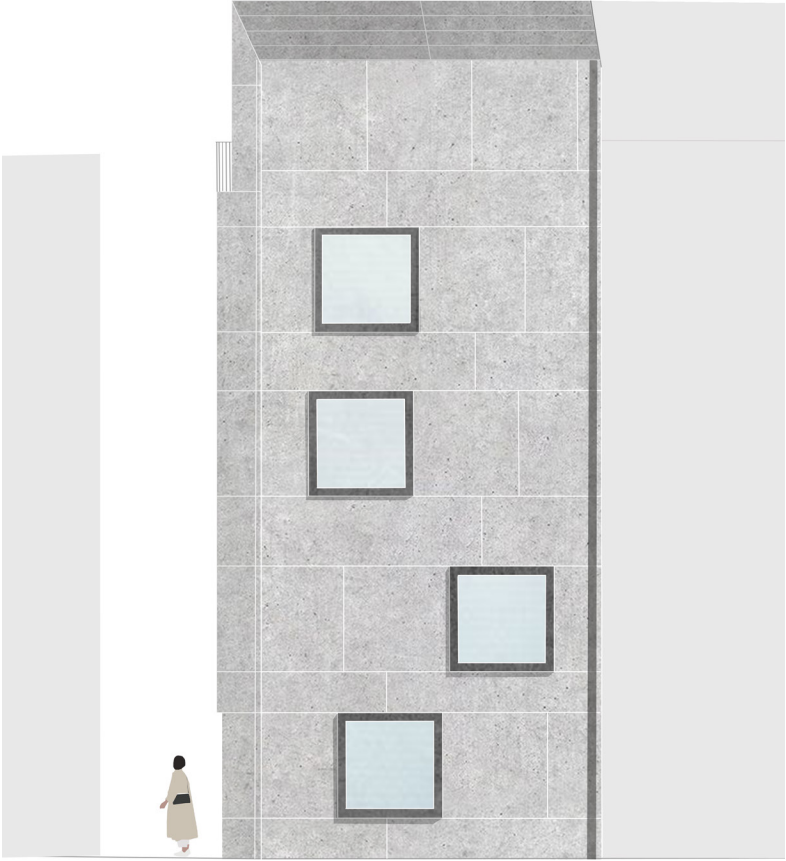



Schnitt A-A  
M 1:50

Gruppe 2  
Martha Bamberg,  
Pauline Brinkmann,  
Masha Grimm

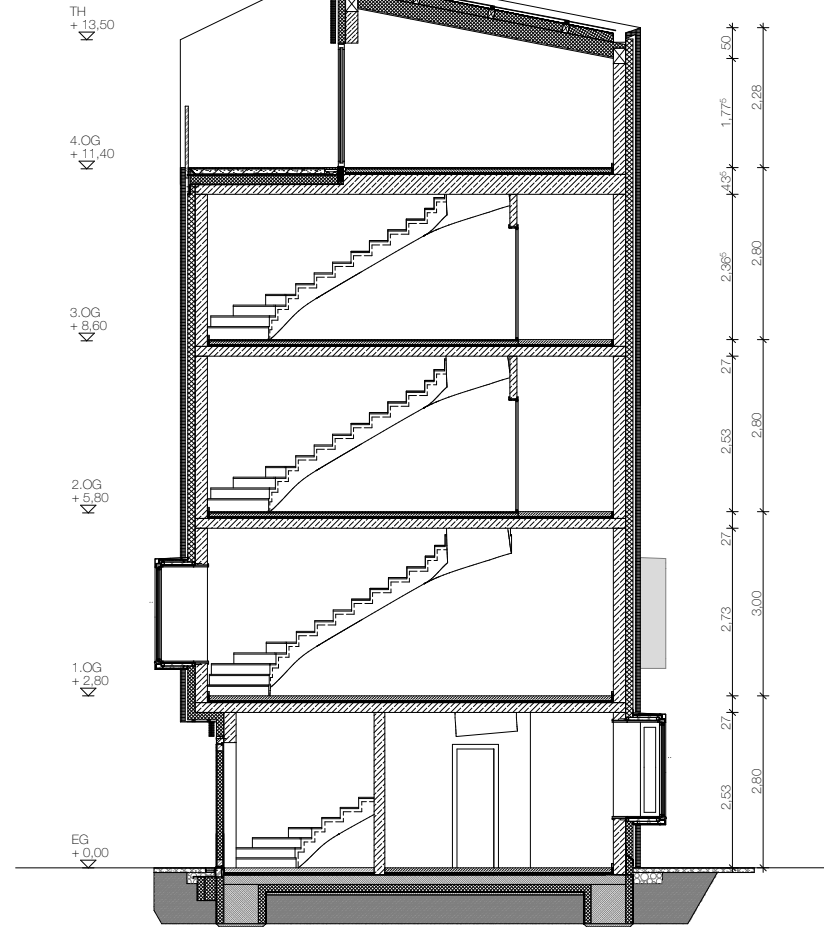

Schnitt B-B  
M 1:50

Gruppe 2  
Marina Blamberg,  
Pauline Brinkmann,  
Maisha Grimm

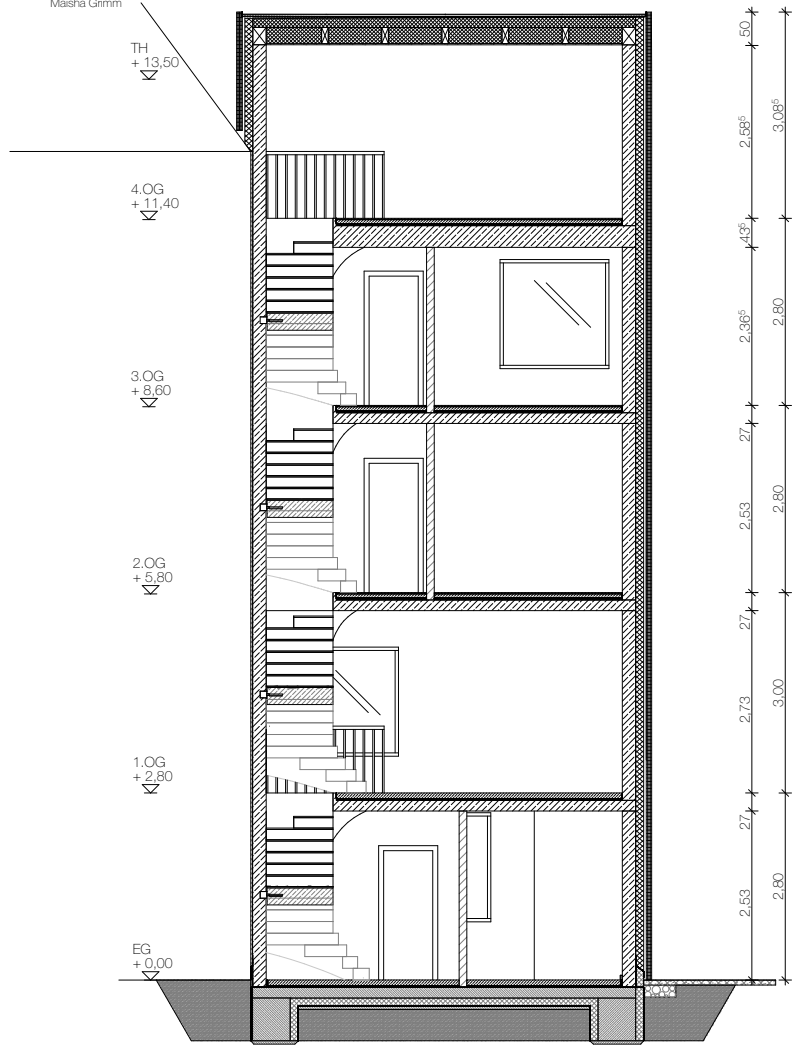

Grundriss und Ansichten  
 Badezimmer  
 M 1:25

Gruppe 2  
 Martha Bamberg,  
 Pauline Brinkmann,  
 Maisha Grimm

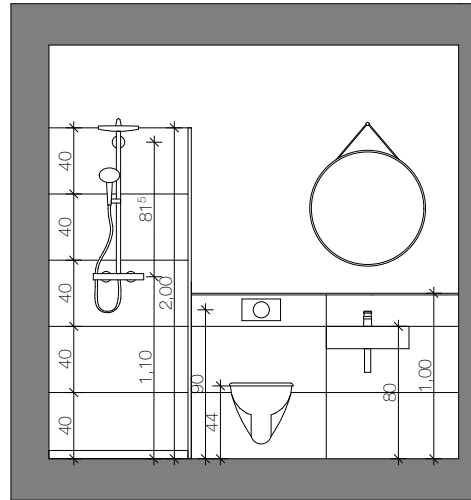

Ansicht A

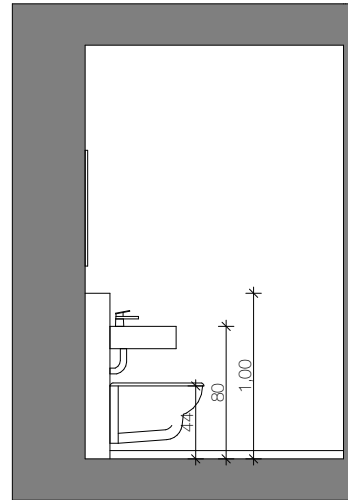

Ansicht B

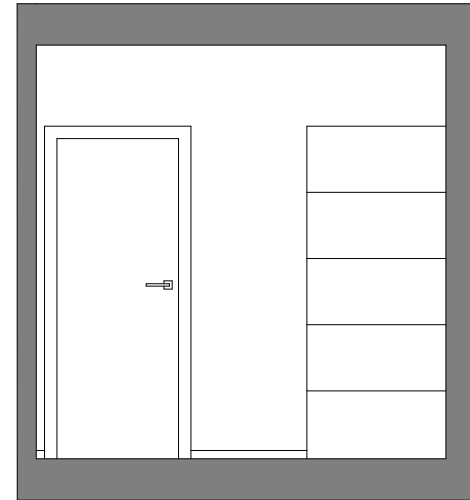

Ansicht C

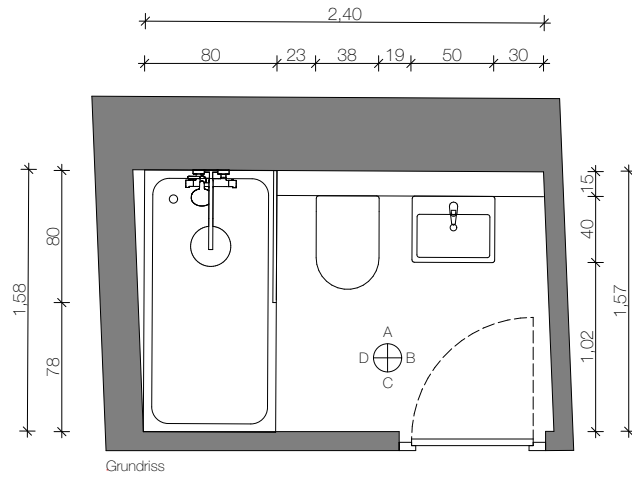

Grundriss

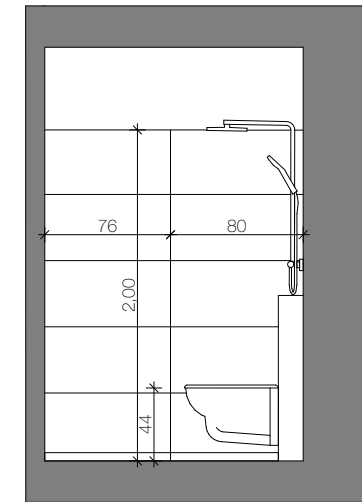

Ansicht D



Detail Wand- /  
Fußbodenaufbau  
M 1:10

Gruppe 2  
Martha Bamberg,  
Pauline Brinkmann,  
Maisha Grimm

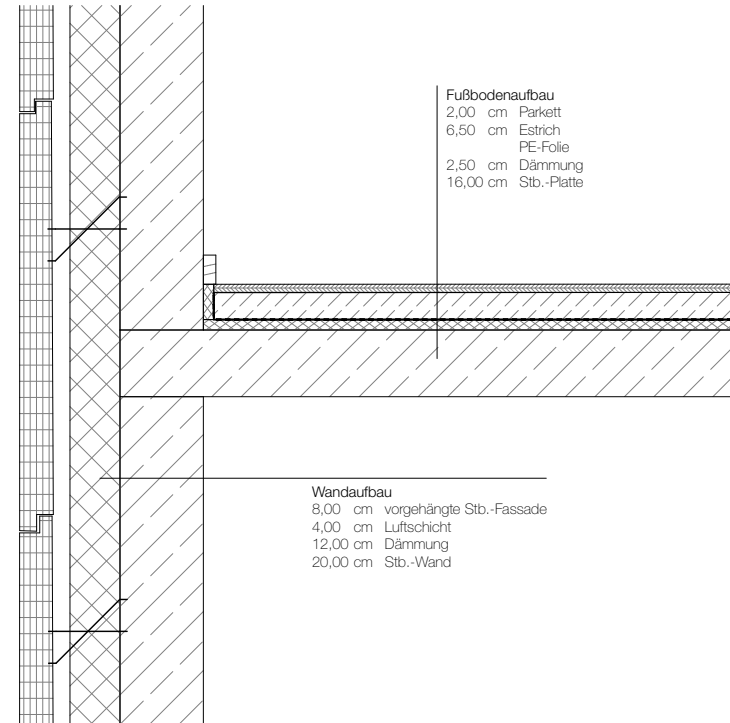
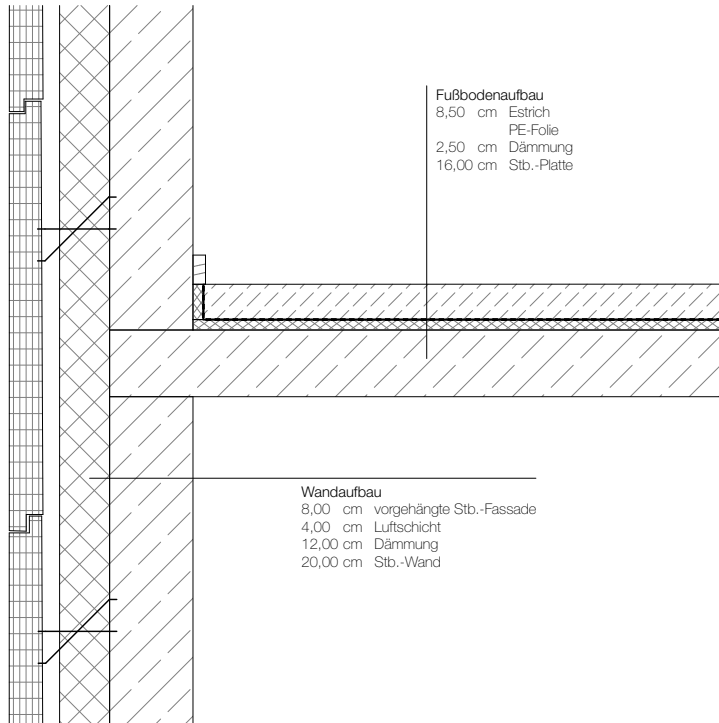

Detail Wandecke  
M 1:10

Gruppe 2  
Martha Bamberg,  
Pauline Brinkmann,  
Maisha Grimm

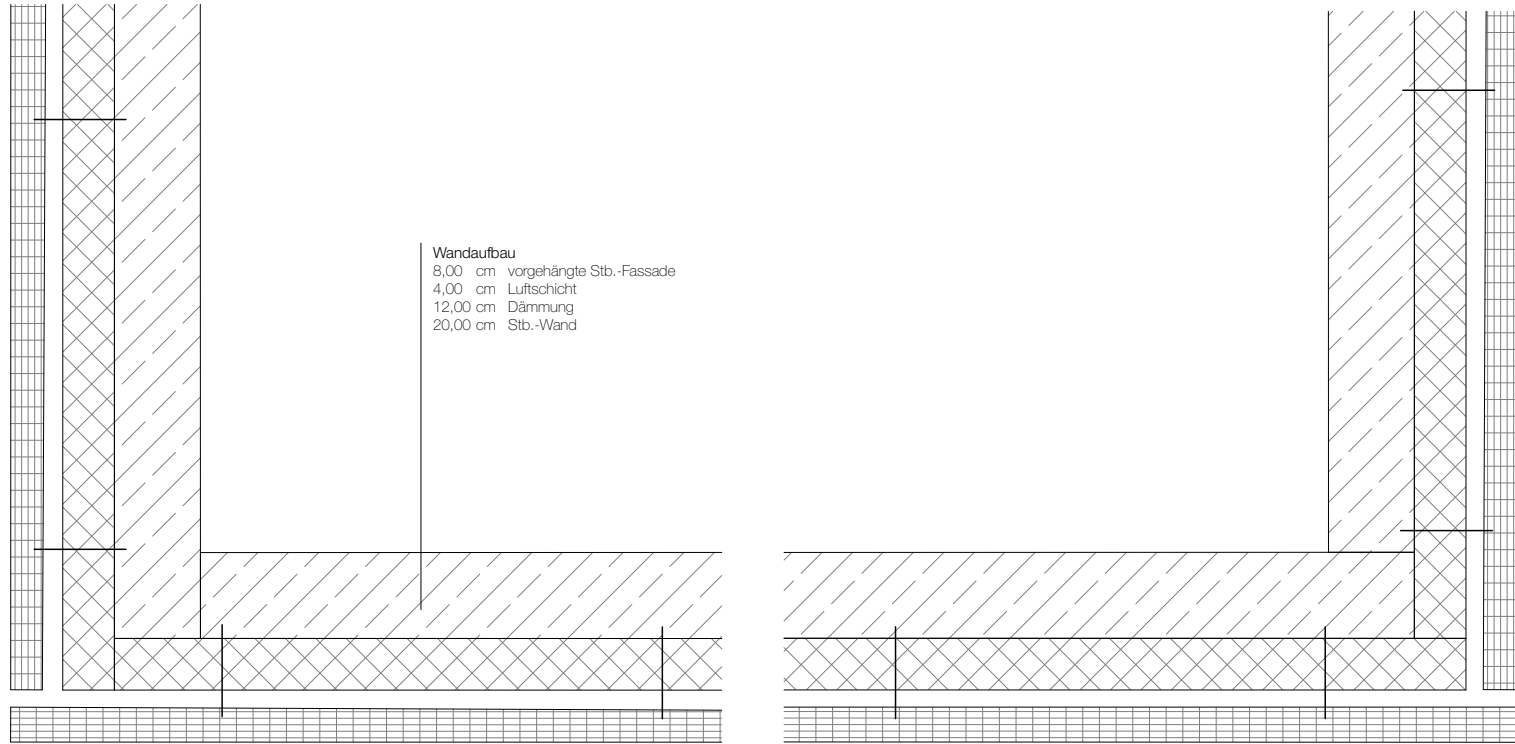

Detail Fassadenversprung  
M 1:10

Gruppe 2  
Martha Bamberg,  
Pauline Brinkmann,  
Maisha Grimm

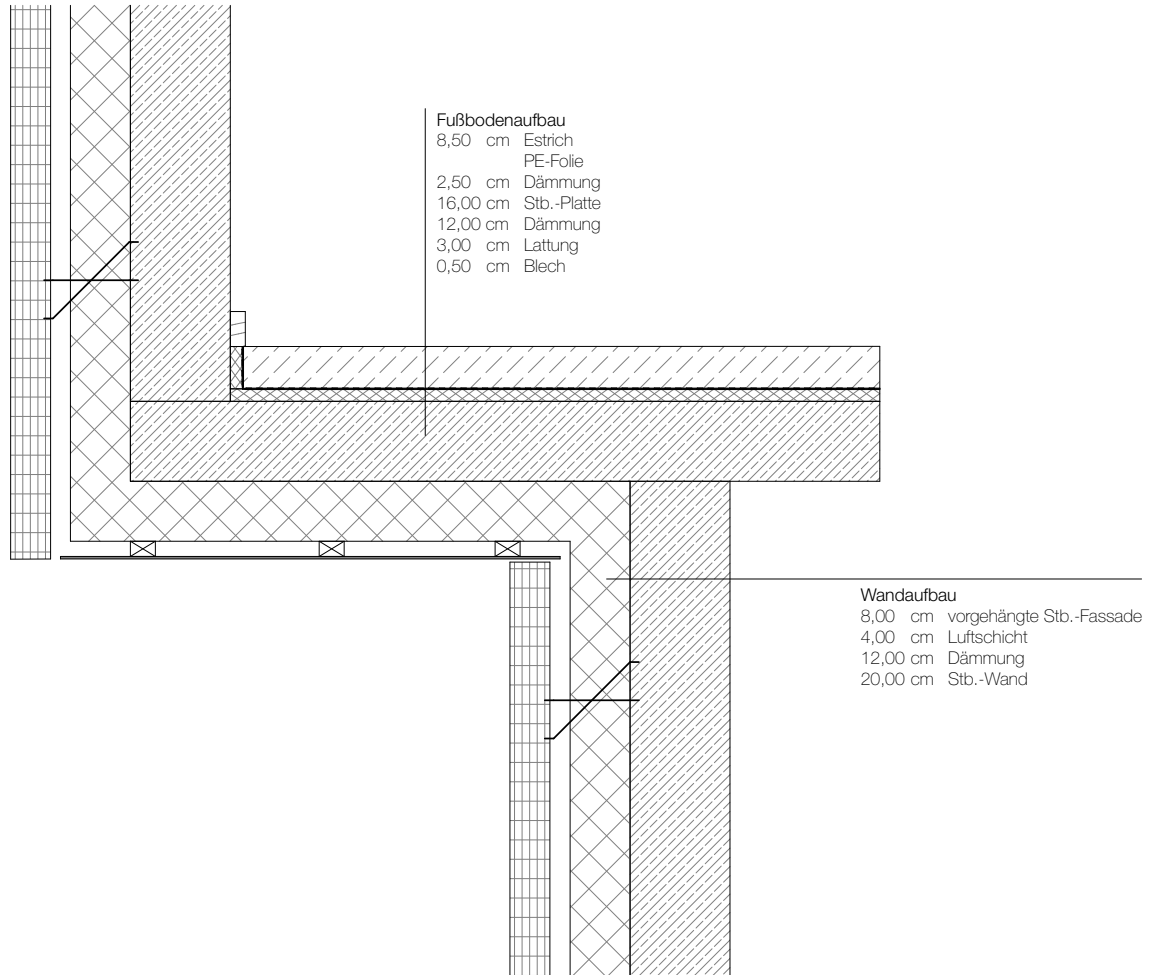

Detail Fußpunkt  
M 1:10

Gruppe 2  
Martha Bamberg,  
Pauline Brinkmann,  
Maisha Grimm

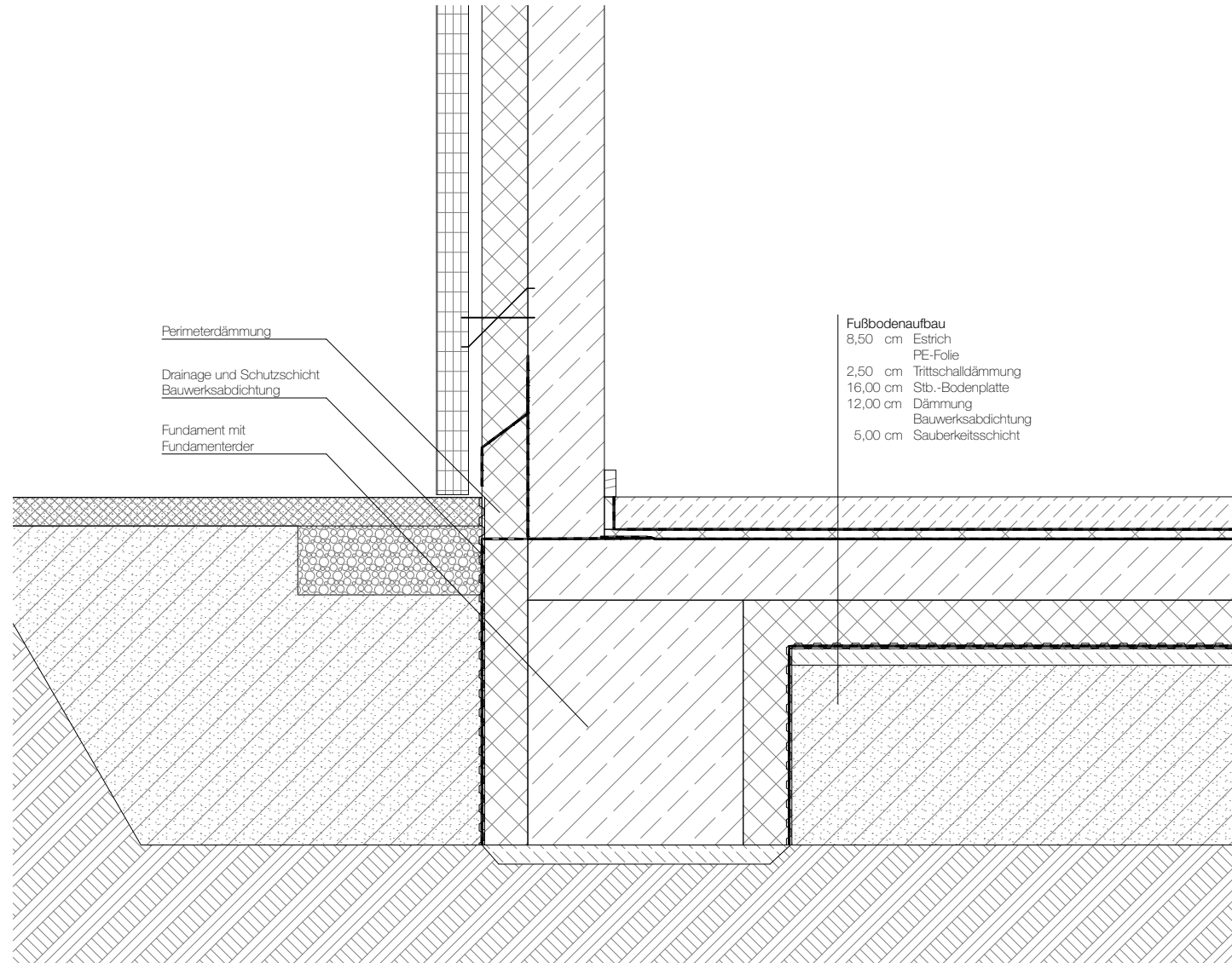

Detail Außentür  
M 1:10

Gruppe 2  
Martha Bamberg,  
Pauline Brinkmann,  
Maisha Grimm

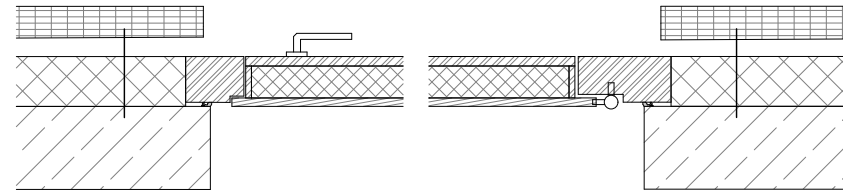
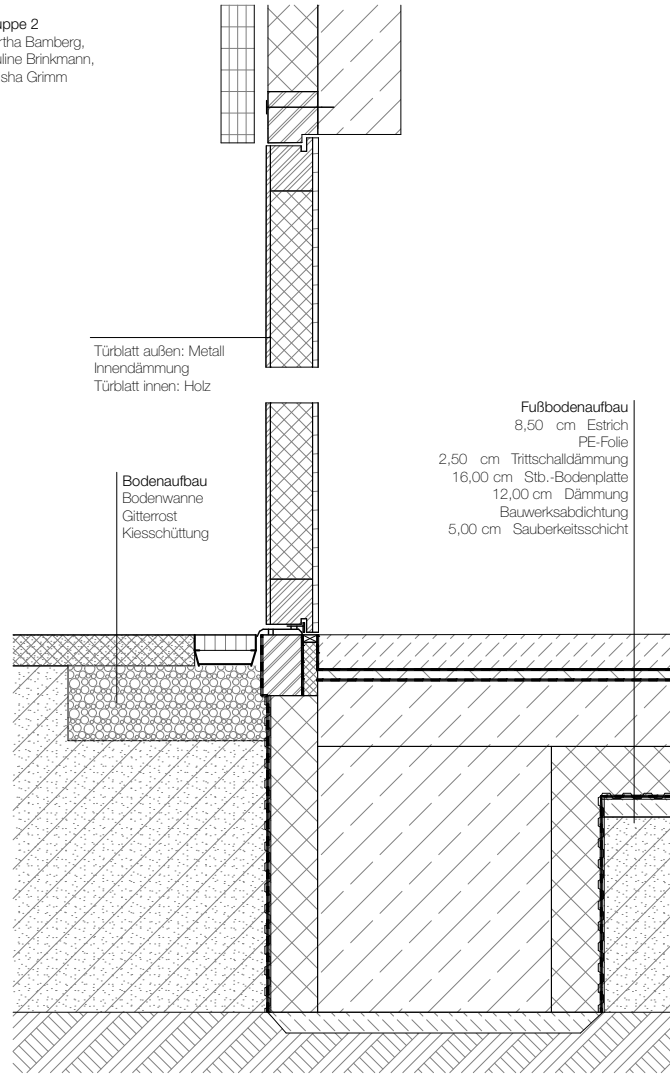

Detail Innentür  
M 1:10

Gruppe 2  
Martha Bamberg,  
Pauline Brinkmann,  
Maisha Grimm

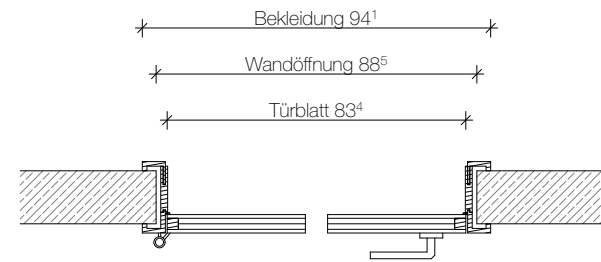
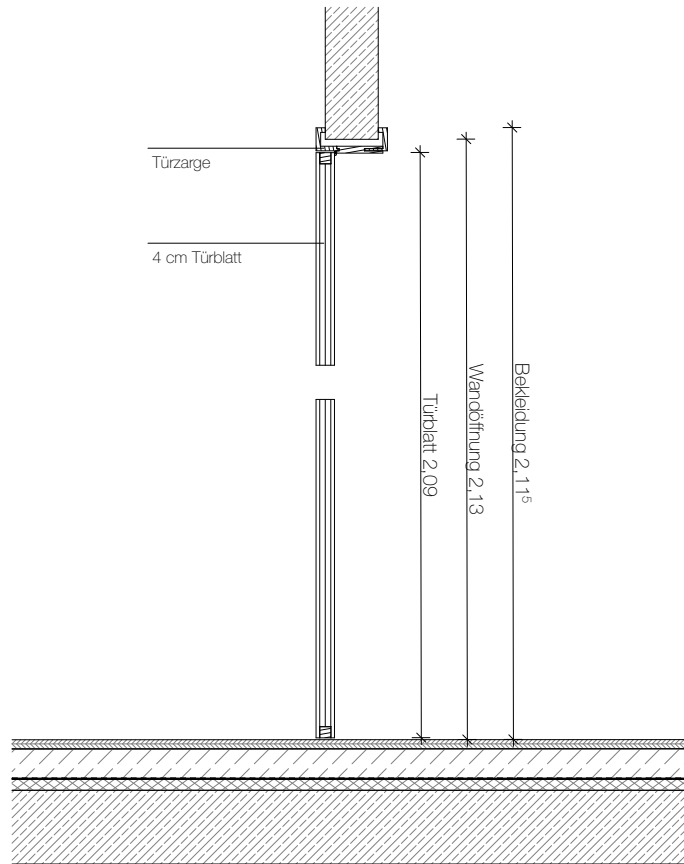

Detail Fenster (vertikal)  
M 1:10

Gruppe 2  
Martha Bamberg,  
Pauline Brinkmann,  
Masha Grimm

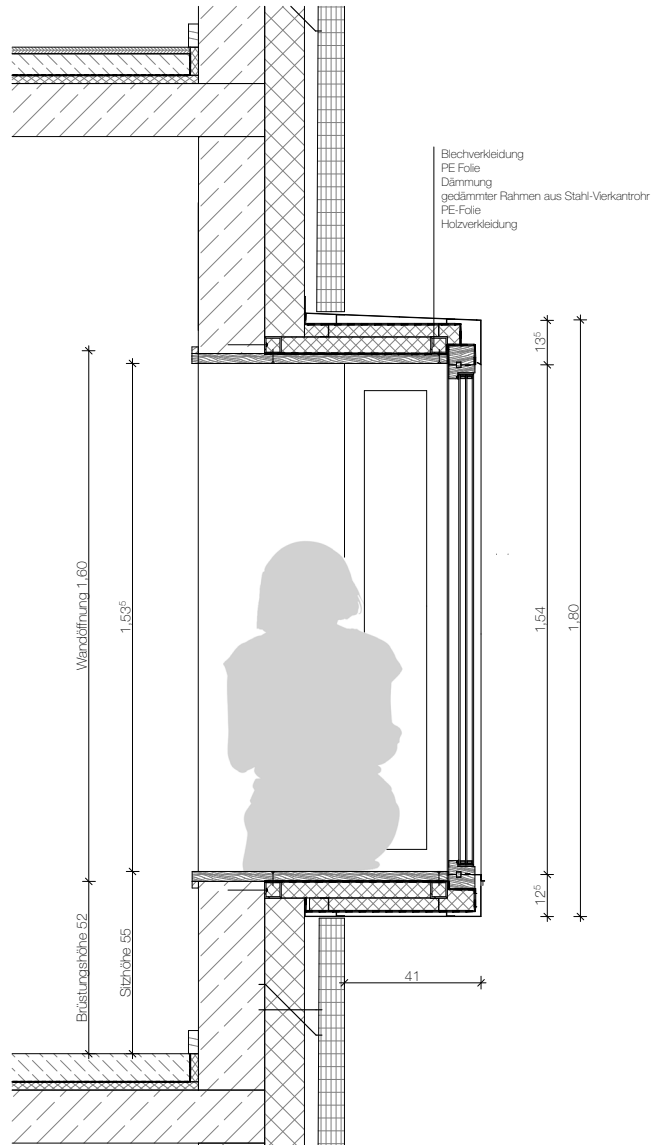

Detail Fenster (horizontal)  
M 1:10

Gruppe 2  
Martha Bamberg,  
Pauline Brinkmann,  
Masha Grimm

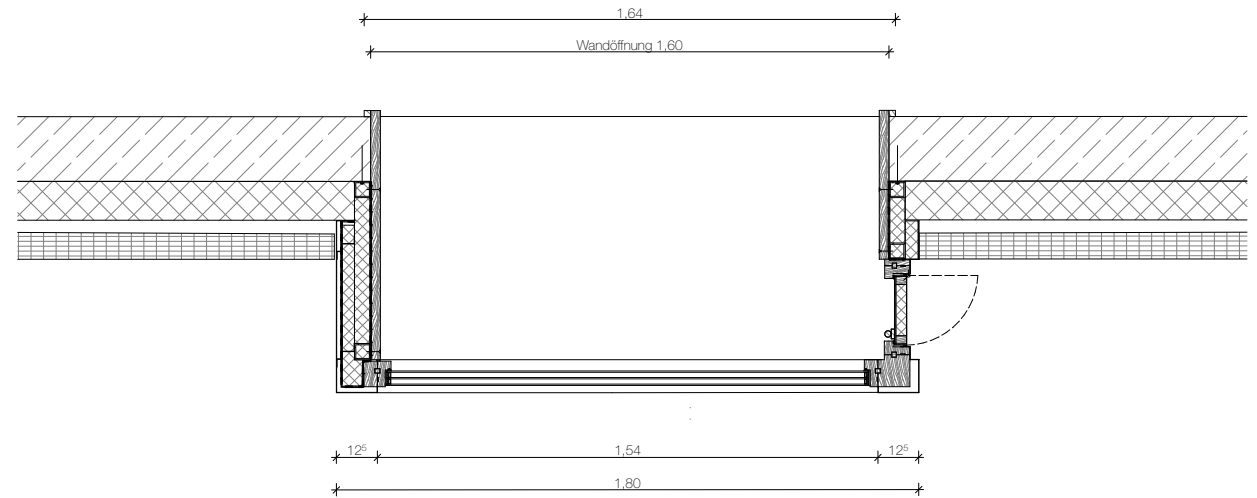



Detail Dachterasse  
M 1:10

Gruppe 2  
Martha Bamberg,  
Pauline Brinkmann,  
Maisha Grimm

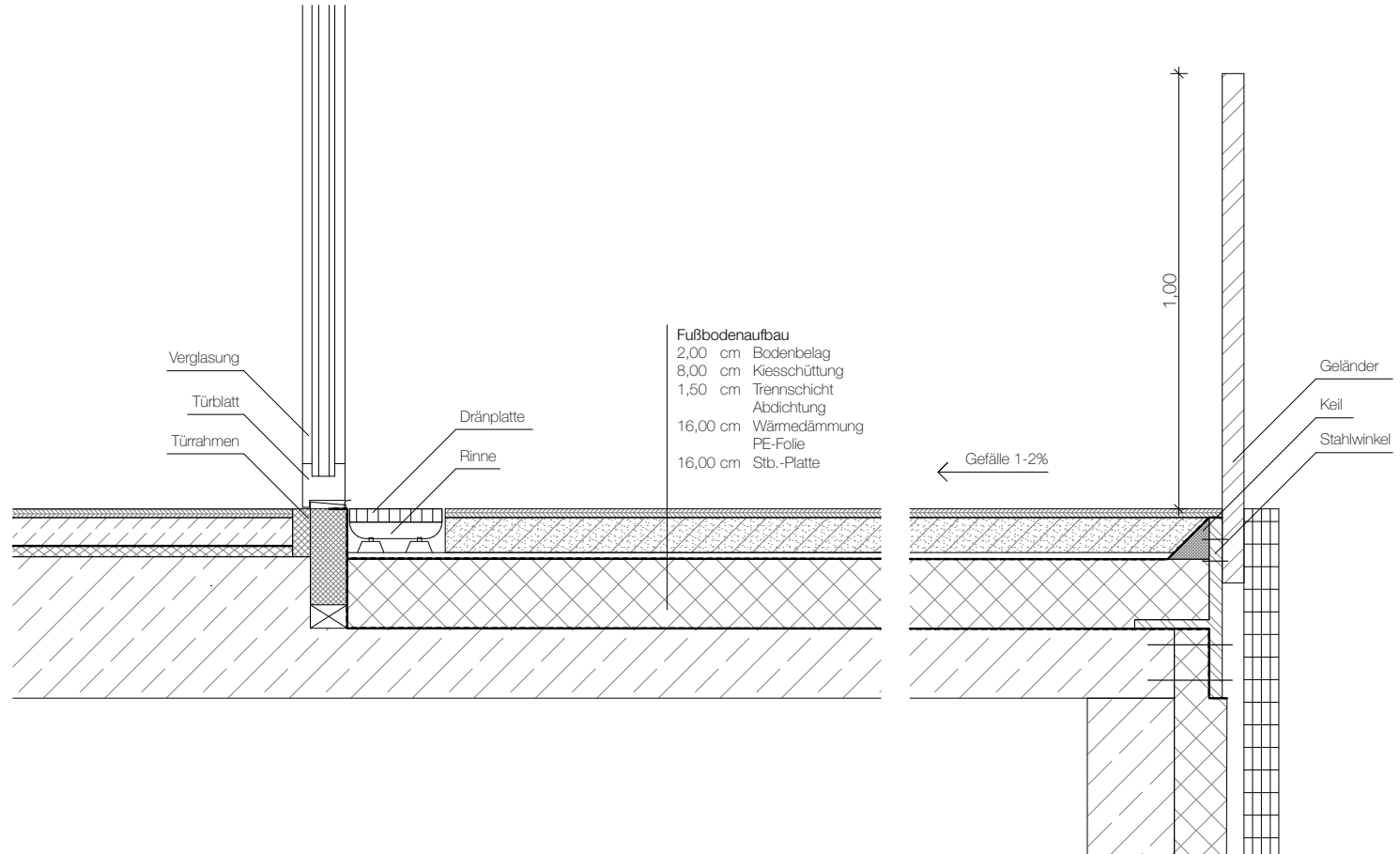

Detail First (Pultdach)  
Detail Traufe  
M 1:10

Gruppe 2  
Martha Bamberg,  
Pauline Brinkmann,  
Maisha Grimm

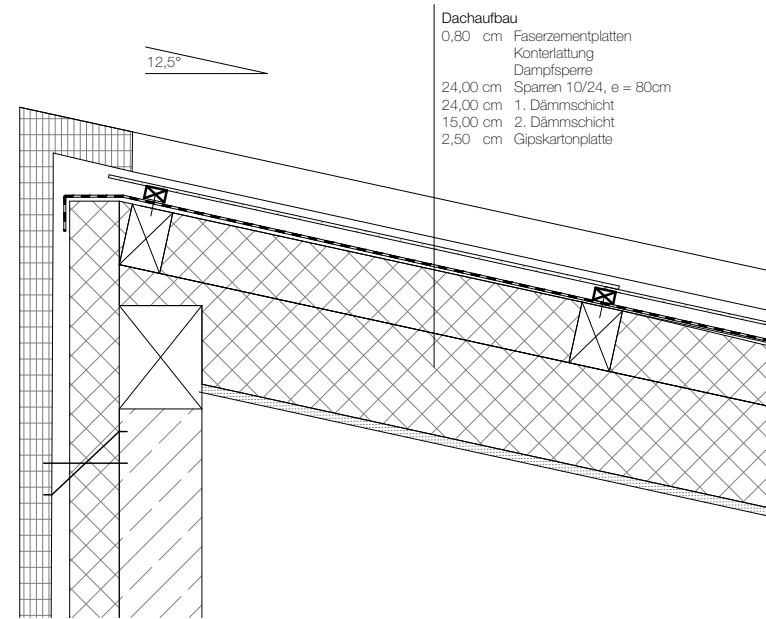
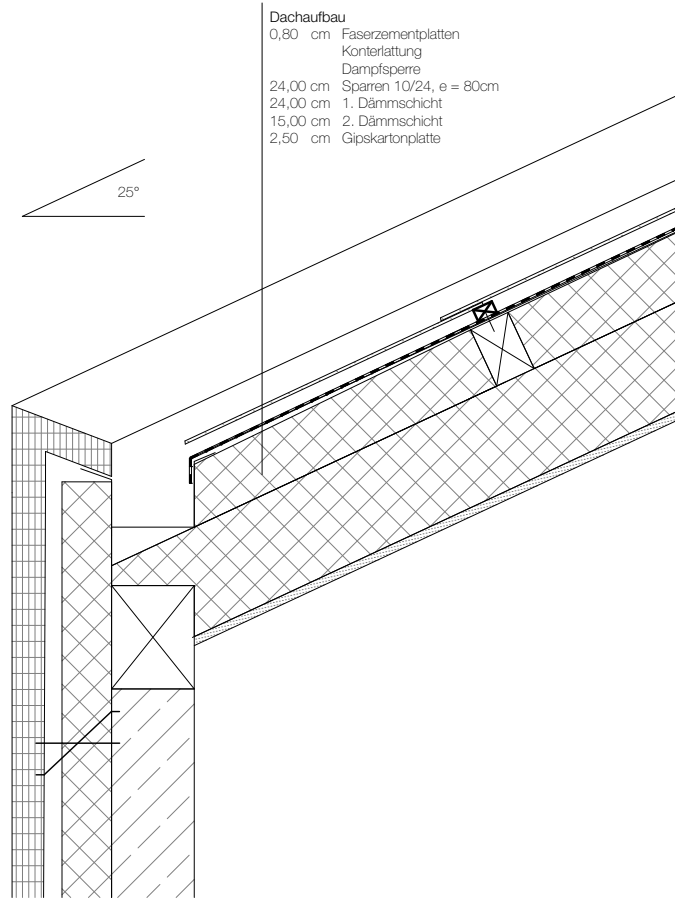

Detail First (Satteldach)  
Detail Ortgang  
M 1:10

Gruppe 2  
Martha Bamberg,  
Pauline Brinkmann,  
Maisha Grimm

Dachaufbau

0,80 cm Faserzementplatten  
Konterlattung  
Dampfsperre  
24,00 cm Sparren 10/24, e = 80cm  
24,00 cm 1. Dämmschicht  
15,00 cm 2. Dämmschicht  
2,50 cm Gipskartonplatte

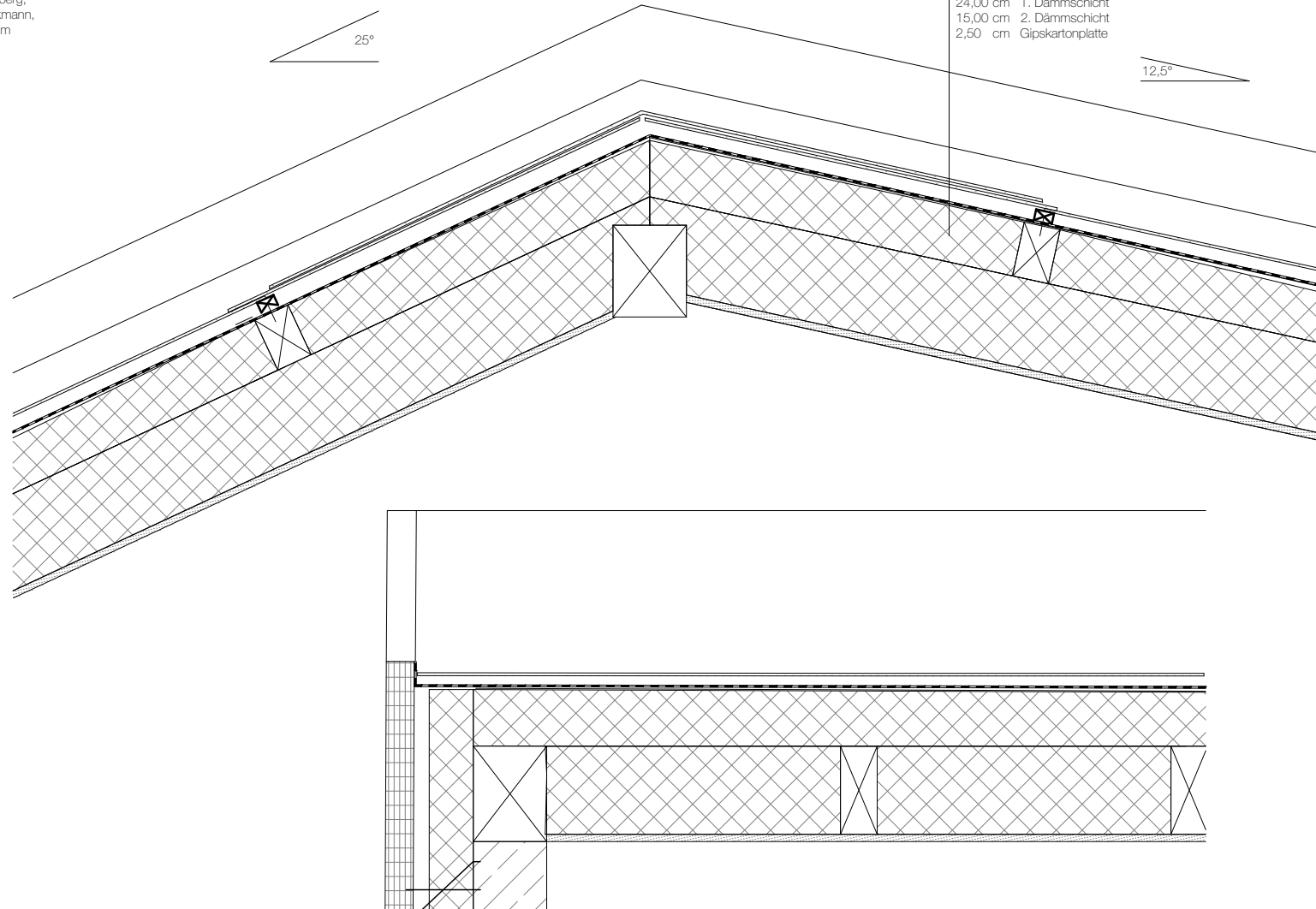

Detail Treppe  
M 1:10

Gruppe 2  
Martha Bamberg,  
Pauline Brinkmann,  
Maisha Grimm

